

Surgical Instruments Catalogue
Chirurgische Instrumente Katalog
Instruments chirurgicaux catalogue

Orthopedic Instruments Catalogue



Manufacturer & Exporters of Surgical Instruments



**SHEFFIELD
SURGICAL
INSTRUMENTS**

Quality

Instruments

Since 1992





SHEFFIELD SURGICAL BUILDING
Wazirabad Road, Ugoki, Sialkot-51310 Pakistan.

WhatsApp # +92-333-0322424
Email: sheffieldsurgicalinstruments@gmail.com
Email: sales@sheffieldsurgicalinst.com
Web: www.sheffieldsurgicalinst.com



Email: sheffieldsurgicalinstruments@gmail.com
Web: www.sheffieldsurgicalinst.com

ELEVATORS

Adson Periosteal Elevator

- 16cm/6¼" length
- Curved blunt

	Width
SSI-3055-16	5mm
SSI-3007-16	7mm



Pennybacker Periosteal Elevator

- 16cm/6¼" length
- Curved sharp

	Width
SSI-3064-16	4mm
SSI-3066-16	6mm
SSI-3068-16	8mm



Bone Raspatory with Tufnol Handle

- 19cm/7½" length



Straight	Width
SSI-7016-19	6mm

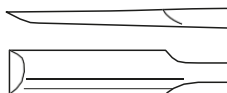

Curved	Width
SSI-7023-19	3mm
SSI-7026-19	6mm



Farabeuf Rugine Elevator

- 15cm/6" length

Straight	Width
SSI-3001-15	12mm

Curved*	Width
SSI-3002-15	12mm



*illustrated

Farabeuf Rugine Elevator with Hollow Handle

- 16cm/6¼" length

Straight	Width
SSI-3011-16	12mm

Curved*	Width
SSI-3012-16	12mm



*illustrated

ELEVATORS

Trethowan Bone Elevator

- 22.5cm/8½" length

SSI-3030- 22



Lanes Bone Elevator

- 26cm/10" length

SSI-3031- 26



Fagge Bone Elevator

- 27.5cm/10¾" length

SSI-3032- 27



Bristow Periosteal Elevator

- 23cm/9" length
- Curved sharp
- 10mm width

SSI-3003- 23



Femoral Dislocation Lever

- 31cm/12½" length
- 26mm width

SSI-3026-31



Muller Femoral Retractor

- 35cm/13½" length
- 28mm width

SSI-3028-35



For retraction of the femoral neck.

MINI ELEVATORS

Mini Bone Lever

- ▣ 14cm/5½"
- ▣ 2.8mm width

SSI-5830-14



Hohmann Style Mini-Bone Lever

- ▣ 16cm/6¼"
- ▣ 6mm width

SSI-5831-16



Phalangeal Lever

- ▣ 15cm/6"
- ▣ 5mm width

SSI-5832-16



Buck-Gramcko Lever

- ▣ 15cm/6"
- ▣ 7.5mm width

SSI-5833-15



Mini-Cobra Bone Lever

- ▣ 16cm/6¼"
- ▣ 15mm width

SSI-5834-16



McGlamry Metatarsal Elevator

- ▣ 17cm/6½"
- ▣ Sharp

Width

SSI-5835-10	9mm
SSI-5835-12	11mm
SSI-5835-14	13mm
SSI-5835-16	15mm
SSI-5835-19	19mm



ELEVATORS

Hohmann Bone Elevator

- 22cm/8½" length
- 8mm width

SSI-3008-22



Hohmann Bone Elevator

- 24cm/9½" length
- 18mm width

SSI-3018-24



Hohmann Bone Elevator

- 24.5cm/9½" length
- 43mm width

SSI-3043-24



Hohmann Large Bone Elevator

- 24cm/9½" length
- 70mm width

SSI-3070-24



Hohmann Bone Elevator

- 28cm/11" length
- 33mm width

SSI-3033-28



Hohmann Bone Elevator

- 26cm/10" length
- 24mm width

SSI-3024-26



Email: sheffieldsurgicalinstruments@gmail.com
Web: www.sheffieldsurgicalinst.com

ELEVATORS

Long Curved Hohmann Inferior Hip Elevator

- 40cm/16" length
- 22mm width

SSI-3022-40



Modified Hohmann Elevator

- 90° angled

Width

SSI-7750-10	10mm
SSI-7750-18	18mm
SSI-7750-25	25mm
SSI-7750-43	43mm
SSI-7750-70	70mm



Modified Cobra Aufrang Elevator

- 33cm/13" long blade
- 30mm x 100mm

SSI-7742-10



Shallow Bone Elevator

- 25cm/9¾" length

SSI-7755-25



Concave Moor Elevator

33cm/13" long blade

SSI-7742-20



Email: sheffieldsurgicalinstruments@gmail.com
 Web: www.sheffieldsurgicalinst.com

ELEVATORS

Murphy Bone Skid Elevator

- 28cm/11" length
- For dislocation of the femoral head
- Double ended

SSI-0589-23



Infero-Posterior Acetabular Capsule Retractor

- 35cm/14" length

Right

SSI-7772-10

Left

SSI-7772-20



PCL Retractor

- 25cm/10" length
- To straddle the cruciate ligament
- 4mm wide prongs
- 21mm wide tips

SSI-7761-10

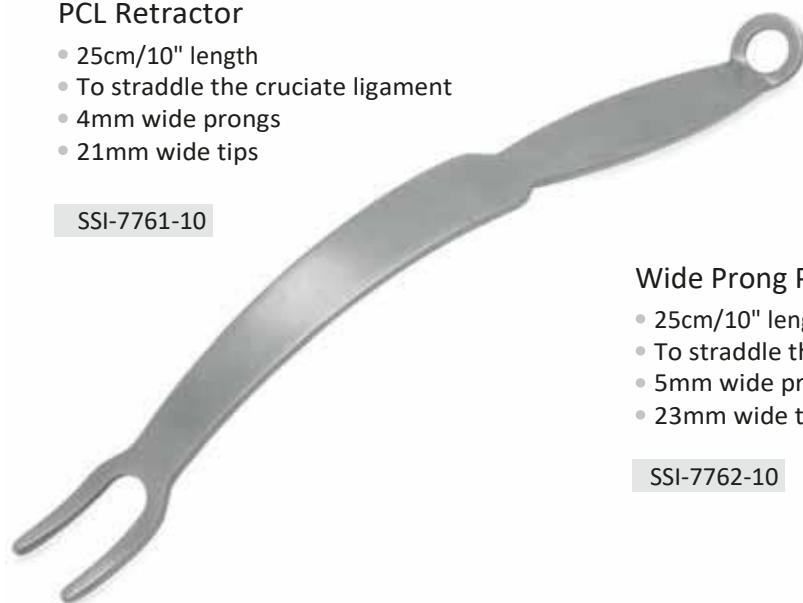

Wide Prong PCL Retractor

- 25cm/10" length
- To straddle the cruciate ligament
- 5mm wide prongs
- 23mm wide tips

SSI-7762-10



ents@gmail.com

Web: www.sheffieldsurgicalinst.com

BOON HOOKS

Bone Hook Sharp

- 24.5cm/9¾" length
- Sharp

SSI-9050- 24



Blunt Hook

- 20cm/8" length

SSI-9051- 20



Wroblenski Dislocating Hook

- 25cm/10" length
- For hooking around the neck of the Femur

SSI-9055- 25



McMinn Dislocating Hook

- 25cm/10" length
- Blunt hook with Tufnol handle

SSI-9057- 25



BONE SPREADERS

Scaphoid Spreader - Fine Pattern

- ▣ 14cm/5½" length
- ▣ 1 x 2 prongs

6mm

SSI-5131-14

= =



Scaphoid Spreader - Standard Pattern

- ▣ 14cm/5½" length

6mm

SSI-5134-14



Baby Inge Bone Spreader

- ▣ 18cm/7" length

7mm
Toothed

7mm
Smooth

7mm
Cross Serrated



SSI-5134-18

SSI-5134-18S

SSI-5134-18X



Scaglietti Lamina Spreader

- ▣ 28cm/11" length
- ▣ With speed lock

SSI-2009-28



Email: sheffieldsurgicalinstruments@gmail.com
 Web: www.sheffieldsurgicalinst.com

BONE CUTTERS

Bohler Bone Cutters

- 15cm/6" length
- Double action

Straight

SSI-5160-50

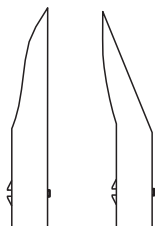

Angled

SSI-5161-50



McIndoe Bone Cutters

- 18cm/7" length
- Double action
- Angled jaws

SSI-1028 -18



Ruskin-Liston Bone Cutters

- 19cm/7½" length
- Double action

Straight

SSI-5170-19



Angled

SSI-5171-19

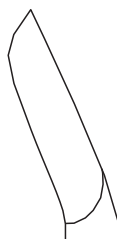

Stille-Liston Bone Cutters

- 27cm/10¾" length
- Double action

Straight

SSI-1024- 27



Angled

SSI-1025- 27



Liston-Key-Horsley Bone Cutters

- 27cm/10¾" length
- Double action
- Angled

SSI-1023- 27

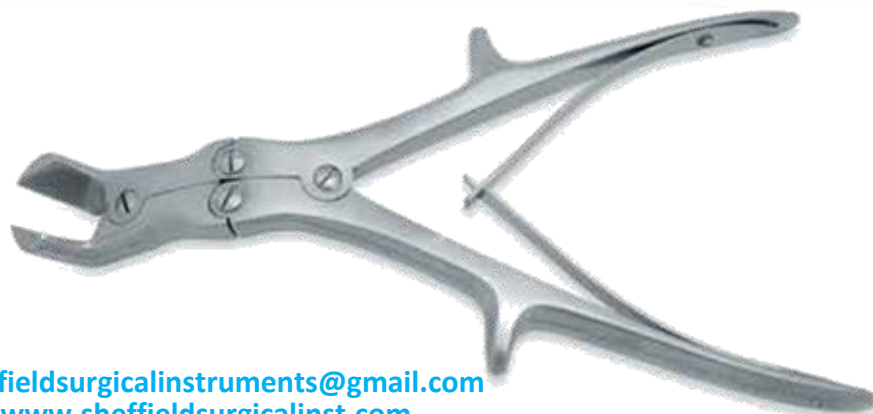

Email: sheffieldsurgicalinstruments@gmail.com
 Web: www.sheffieldsurgicalinst.com

BONE NIBBLERS

Kleinert-Kutz Bone Nibbler

- ▣ 14cm/4½" length
- ▣ Curved

2mm Bite

SSI-5118-50



Lempert Bone Nibbler

- ▣ 19cm/7½" length
- ▣ Single action

3mm Bite

SSI-1001-19



Luer Bone Nibbler

- ▣ 18cm/7" length
- ▣ Single action



Straight
8mm Bite

SSI-1004-18



Curved
8mm Bite

SSI-1005-18



Adsons Bone Nibbler

- ▣ 20cm/8" length
- ▣ Single action



7mm Bite

SSI-1040-20



BONE NIBBLERS

Bohler Bone Nibbler

- ▣ Curved double action
- ▣ 15cm/6"

3mm Bite

SSI-5120-50

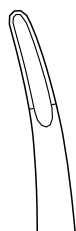

Marquardt Bone Nibbler

- 20cm/8" length
- Curved double action

3mm Bite

SSI-1002-20

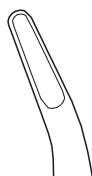

Beyer Bone Nibbler

- ▣ Curved double action
- ▣ 18cm/7"

4mm Bite

SSI-1002-18

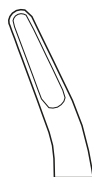

Jansen Bone Nibbler

- ▣ Curved double action
- ▣ 18cm/7"

5mm Bite

SSI-1003-18

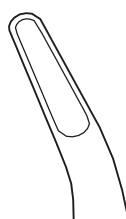

Email: sheffieldsurgicalinstruments@gmail.com
Web: www.sheffieldsurgicalinst.com

BONE NIBBLERS

Smith-Peterson Bone Nibbler

- 24cm/9½" length
- Double action

Straight	Light Curve	Bite Size
SSI-1010-24	SSI-1014-24	3mm
SSI-1011-24	SSI-1015-24	4mm
SSI-1012-24	SSI-1016-24	5mm
SSI-1013-24	SSI-1017-24	6mm

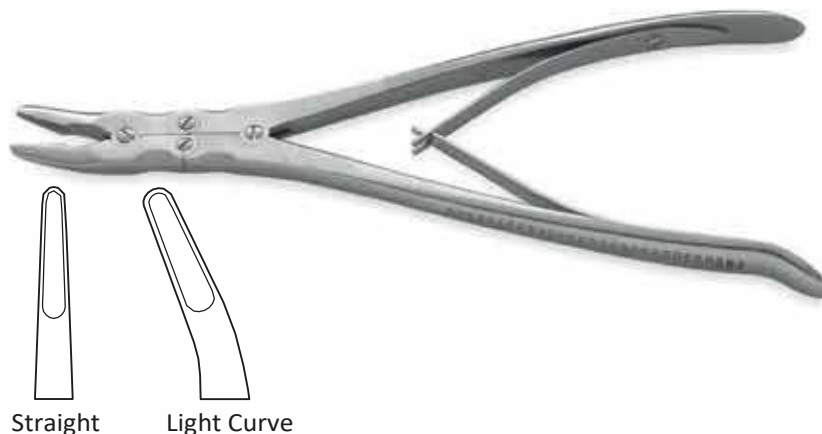

Leksell Bone Nibbler

- 24cm/9½" length
- Double action angled

Angled Jaw	Bite Size
SSI-1018-24	3mm
SSI-1019-24	5mm
SSI-1020-24	8mm

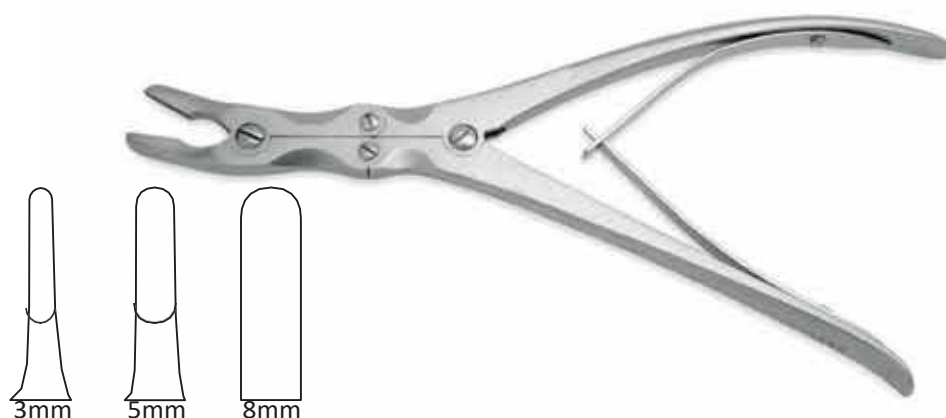

Stille-Luer Bone Nibbler

- 22cm/8¾" length
- Double action

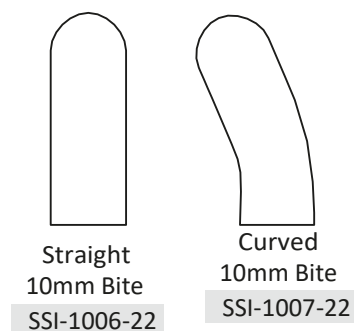

'Mr Blobby' Stille-Luer Bone Nibbler

- 26cm/10¼" length
- Double action

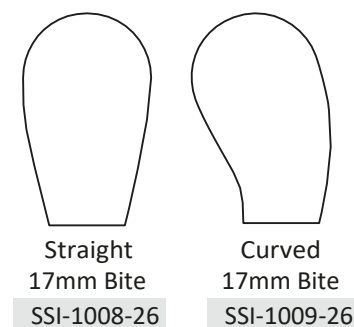

Email: sheffieldsurgicalinstruments@gmail.com
 Web: www.sheffieldsurgicalinst.com

BONE HOLDING FORCEPS

Langenbeck Bone Holding Forceps

- 20cm/8" length
- 5mm

SSI-5120-05



Frosch Bone Holding Forceps

- 18cm/7" length
- Toothed/serrated jaws

SSI-6141-18



St. Thomas Bone Holding Forceps

- 18cm/7" length
- Screw joint

SSI-6170-18



Fergusson Bone Holding Forceps

- 20cm/8" length
- Screw joint

SSI-6140-20



Langenbeck Bone Holding Forceps

- 21cm/8¼" length

SSI-6144-21



BONE HOLDING FORCEPS

Semb Bone Holding Forceps

- 19cm/7½" length
- Angled to side

SSI-6147-18



Hey Groves Bone Holding Forceps

- Screw joints
- Serrated jaws



Length

SSI-6145 -20	20cm/8"	Small
SSI-6145 -25	25.5cm/10"	Medium
SSI-6145 -30	30.5cm/12"	Large

Verbrugge Bone Holding Forceps



Length

SSI-6150 -25	25cm/10"	Small
SSI-6150-26	26cm/10½"	Medium
SSI-6150 -27	27cm/11"	Large

PELVIC REDUCTION INSTRUMENTS

Pelvic Reduction Forceps

- 19cm/7½" length
- Angled, small
- Pointed ball tips
- Speed lock

SSI-6151-19



Pelvic Reduction Forceps

- 23cm/9" length
- Angled, large
- Pointed ball tips
- Speed lock

SSI-6152-23



Pelvic Reduction Forceps

- 25cm/10" length
- Straight, large
- Pointed ball tips
- Speed lock

SSI-6153-25



PELVIC REDUCTION INSTRUMENTS

Pelvic Reduction Forceps

- 40cm/16" length
- Pointed ball tips
- Speed lock

SSI-6154-40



Pelvic Reduction Forceps

- 40cm/16" length
- 3 pointed ball tips
- Speed lock

SSI-6155-40



RETRACTORS

Meyerding Retractor

- 22cm/9" length



Blade size

SSI-5050-22	50mm x 16mm
SSI-5075-22	70mm x 25mm
SSI-5090- 22	90mm x 50mm

Langenbeck Retractor

- 21.5cm/8½" length



Blade size

SSI-5122-21	22mm x 6mm	Small
SSI-5145-21	45mm x 13mm	Medium
SSI-5165- 21	65mm x 25mm	Large
SSI-5190- 21	90mm x 20mm	Extra large

Volkman Catpaw Retractor

- 21.5cm/8½" length
- Semi sharp teeth

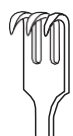

15 x 15mm
3 Prong

SSI-5015-21



15 x 20mm
4 Prong

SSI-5020-21

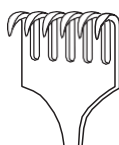

15 x 30mm
6 Prong

SSI-5030-21

HIP RETRACTORS

Charnley Initial Incision Retractor Set

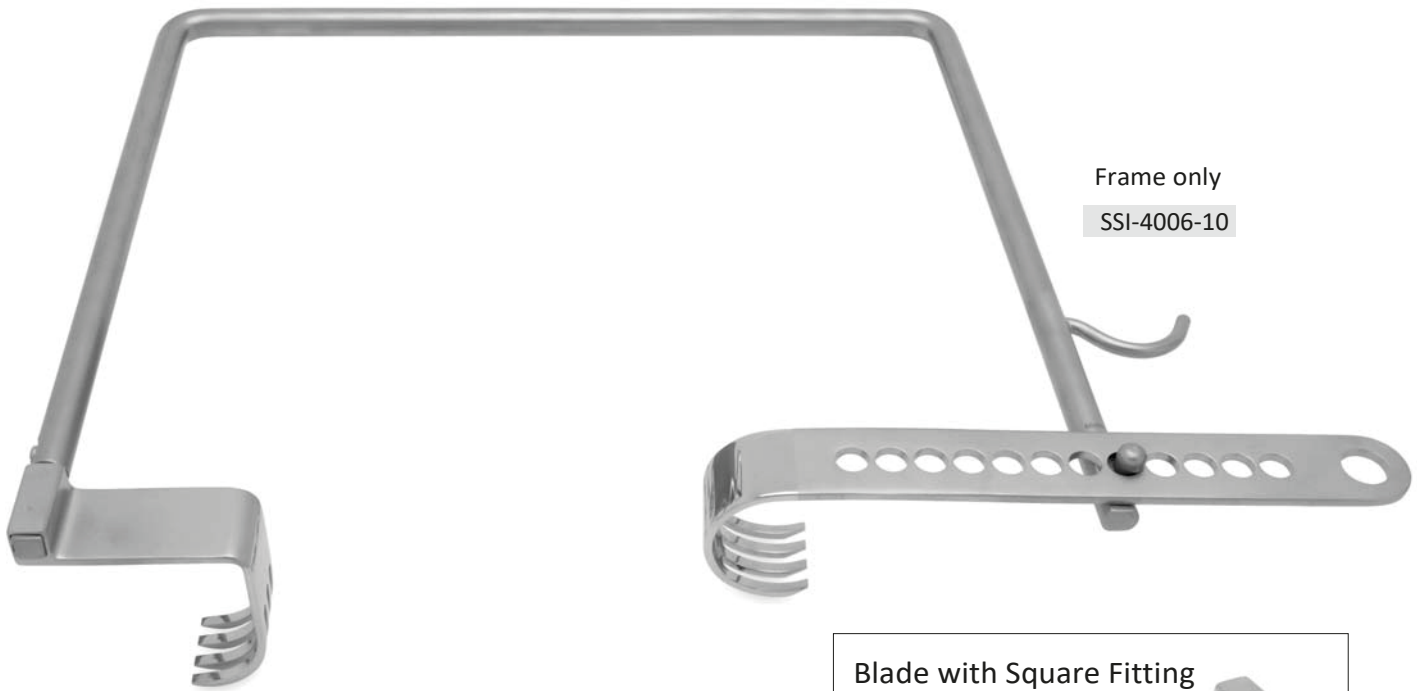

Frame only

SSI-4006-10

SSI-4006- 00 Complete Set - Basic

Consisting of:

- 1x Frame
- 1x Weight & chain
- 1x Square fitting blade - 50mm depth
- 1x Round fitting blade - 40mm depth

SSI-4006- 05 Complete Set - Extended

Consisting of:

- 1x Frame
- 1x Weight & chain
- 3x Square fitting blades:
 - 50mm depth
 - 75mm depth
 - 100mm depth
- 3x Round fitting blades:
 - 40mm depth
 - 75mm depth
 - 100mm depth

Blade with Square Fitting



SSI-4006-50 Standard depth 50mm

SSI-4006-75 Extra depth 75mm

SSI-4006-10 Extra, extra depth 100mm

Blade with Round Fitting

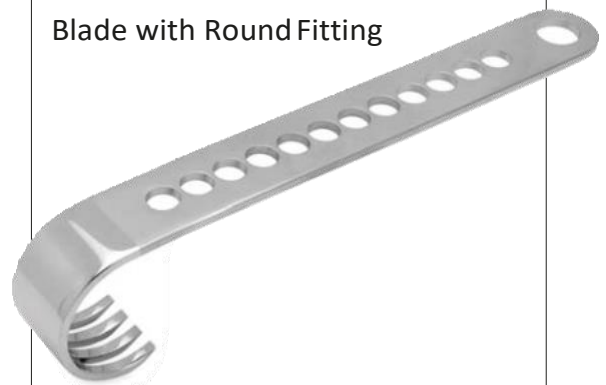

SSI-4007-40 Standard depth 40mm

SSI-4007-75 Extra depth 75mm

SSI-4007-10 Extra, extra depth 100mm

To spread the incision in the fascia lata. It is combined with a weight and chain, which tilts the retractor to an angle of 45° to improve exposure of the anterior aspect of the joint.



Weight & chain

SSI-4006-07

Email: sheffieldsurgicalinstruments@gmail.com
 Web: www.sheffieldsurgicalinst.com

RETRACTORS

Wests S/R Retractor

- 14cm/5½" length
- 3 x4 Sharp prongs

SSI-4003- 14



Weitlaner S/R Retractor

- 14cm/5½" length
- 3 x4 Blunt prongs

SSI-4002- 14



Travers S/R Retractor

- 20cm/8" length
- 4 x 5 Blunt prongs

SSI-4004- 20



Norfolk and Norwich S/R Retractor

- 20cm/8" length
- 4x5 Blunt prongs

SSI-4000- 20



Gelpi Laminectomy Retractor

- Sharp prongs

	Length	Prong depth
SSI-4030-16	18.5cm/7¼"	30mm
SSI-4050-16	19.5cm/7¾"	50mm
SSI-4070-16	20cm/8"	70mm



RETRACTORS

Charnley Vertical Retractor

- 24.5cm/9½" length
- 3x4 Sharp prongs
- Blade depth 22mm

SSI-4007-24



Cones Self Retaining Retractor

- 3x4 Prongs
- Jointed arms



Blunt Prongs	Length	Depth	Sharp Prongs	Length	Depth
SSI-4064-13	13cm/5"	15mm	SSI-4063-13	13cm/5"	15mm
SSI-4066-16	16cm/6 ½"	15mm	SSI-4065-16	16cm/6 ½"	15mm
SSI-4068-20	20cm/8"	20mm	SSI-4067-20	20cm/8"	20mm
SSI-4070-24	24cm/9 ½"	25mm	SSI-4069-24	24cm/9 ½"	25mm

Harvey Jackson Self Retaining Retractor

- 30.5cm/12" length
- Blade depth 45mm
- 3x3 Sharp prongs

SSI-4010-30



RETRACTORS

Charnley Horizontal Hip Retractor

- 28cm/11" length
- Blade depth 18mm
- Hinged joint
- 7" opening

SSI-4006-28



To retract the detached trochanter headwards, and the femur towards the feet

Hardinge Horizontal Retractor

- Blade depth 18mm
- Hinged joint

SSI-4007-28



Charnley Pin Retractor

Complete set with:

- T-handle introducer
- Pair of pins with chains

SSI-1100 - 00



SSI-1101-00 T-handle only



SSI-1102-00 Pair of pins with chain only

One pin, or sometimes two, is driven into the bone of the superior lip of the acetabulum, to stake back the capsule to give a clear view of the superior lip of the acetabulum. The nerve supply to the tensor fasciae femoris is preserved in this exposure by restricting dissection in the cleft in front of the gluteus medius, but this restricts exposure. By using pins to stake back the abductor muscles, a good exposure of the acetabulum can be obtained, and at the same time the nerve supply to tensor fasciae femoris can be preserved.

The short pins do not obstruct the surgeon's hand in access to the acetabulum. The chain is a safety device to prevent the pins being left in situ.

RETRACTORS

Viper Hinged Scoliosis Retractor

- 30cm/11¾" length
- Sharp

Depth Prongs

SSI-7248-38H	40mm
SSI-7248-40H	70mm
SSI-7248-50H	100mm

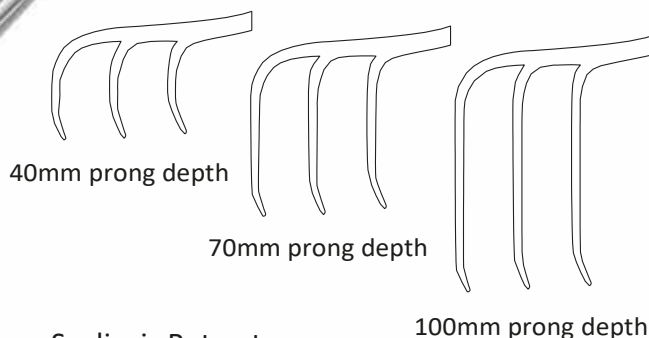
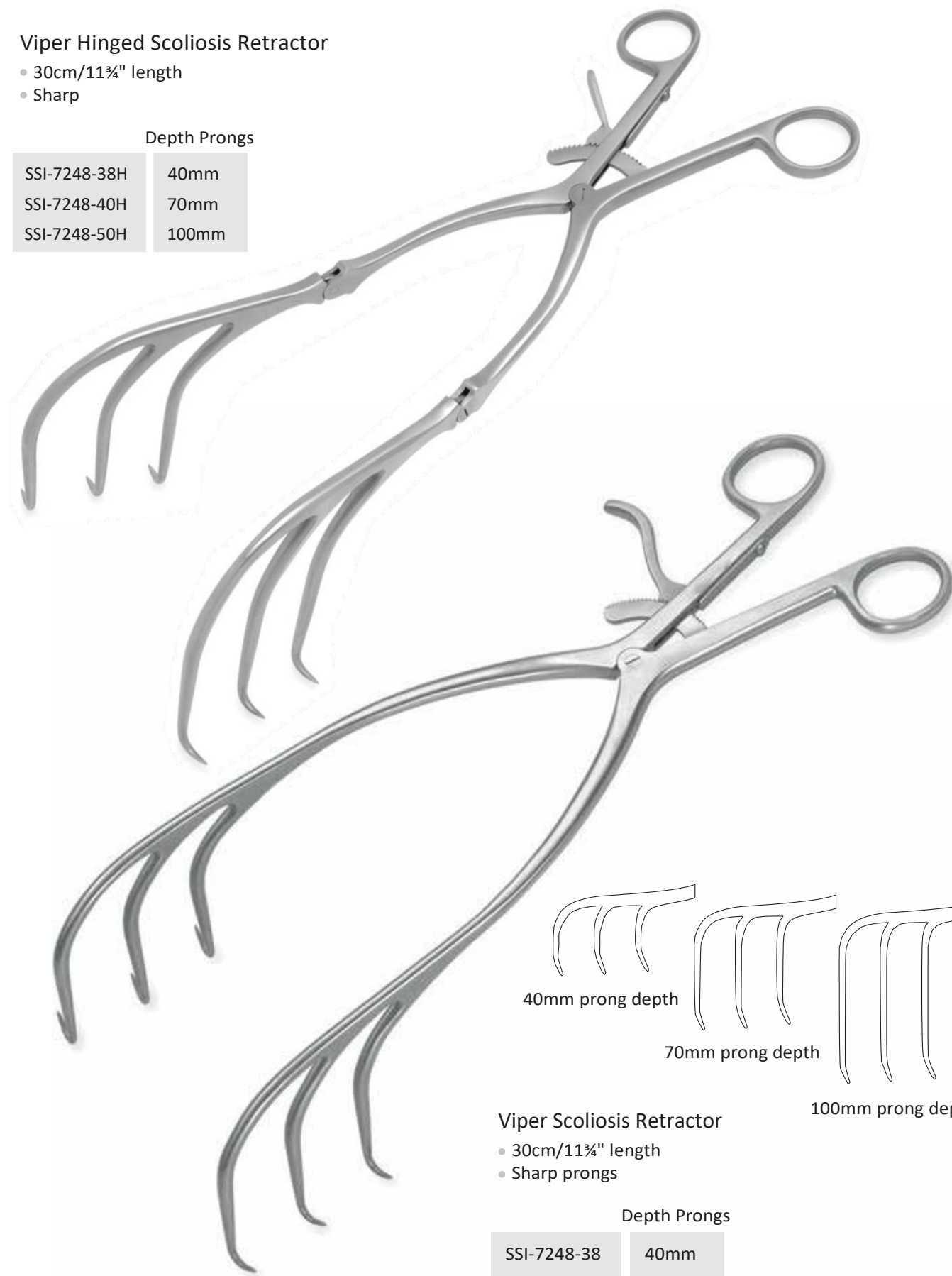

Viper Scoliosis Retractor

- 30cm/11¾" length
- Sharp prongs

Depth Prongs

SSI-7248-38	40mm
SSI-7248-40	70mm
SSI-7248-50	100mm

Email: sheffieldsurgicalinstruments@gmail.com
 Web: www.sheffieldsurgicalinst.com

MALLETS

Toffee Mallet

- ❏ 19cm/7½" length
- ❏ Head size 22mm Ø
- ❏ Weight 165g/6oz

SSI-5808-21



Ultra Fine Mallet

- ❏ 17cm/6¾" length
- ❏ Head size 20mm Ø
- ❏ Weight 145g/5oz

SSI-5801-17



Heath Mallet

- 19cm/7" length
- Stainless steel head
- Head size 40mm Ø
- Weight 1020g/36oz

SSI-5809-19



Mallet with Tufnol Handle

- ❏ 23cm/9" length
- ❏ Small head size 30mm Ø
- ❏ Weight 350g/12oz

SSI-5803-23

- ❏ Medium head size 35mm Ø
- ❏ Weight 550g/20oz

SSI-5804-23

- ❏ Large head size 40mm Ø
- ❏ Weight 700g/25oz

SSI-5805-23



MALLETS

London Splint Mallet

- ▣ 18cm/7" length
- ▣ Head size 30mm Ø
- ▣ Weight 450g/16.2oz

SSI-5802-18



Ombredanne Mallet

- 24cm/9½" length
- Head size 40mm Ø
- Weight 550g/20oz

SSI-5806-24



Mallet with Tufnol Handle

- 24cm/9½" length
- Lead filled head
- Weight 400g/14oz

SSI-5810-24



Tufnol Mallet

- 25.5cm/10" length
- Head size 42mm Ø
- Weight 250g/10oz

SSI-5807-25



OSTEOTOMES

Mini-Lambotte Osteotome

▣ 12.5cm/5" length

	Width
SSI-5270- 02	2mm
SSI-5270- 03	3mm
SSI-5270- 04	4mm
SSI-5270 -06	6mm
SSI-5270 -08	8mm

Set of 5 sizes:
2mm to 8mm

SSI-5270 -28



Lambotte Osteotome

▣ 25cm/9¾" length

Straight	Width
SSI-7970- 04	4mm
SSI-7970- 06	6mm
SSI-7970- 08	8mm
SSI-7970-10	10mm
SSI-7970-13	13mm
SSI-7970-16	16mm
SSI-7970-18	18mm
SSI-7970- 20	20mm
SSI-7970- 25	25mm
SSI-7970- 30	30mm

Curved	Width
SSI-7971- 04	4mm
SSI-7971- 06	6mm
SSI-7971- 08	8mm
SSI-7971-10	10mm
SSI-7971-13	13mm
SSI-7971-16	16mm
SSI-7971-18	18mm
SSI-7971- 20	20mm
SSI-7971- 25	25mm
SSI-7971- 30	30mm



Ultra Fine Osteotome (Titanium Nitrate Coated)

▣ 16cm/6¼" length

	Width
SSI-5230 - 02	2mm
SSI-5230 - 04	4mm
SSI-5230 - 06	6mm
SSI-5230 -08	8mm
SSI-5230 -10	10mm
SSI-5230 -12	12mm

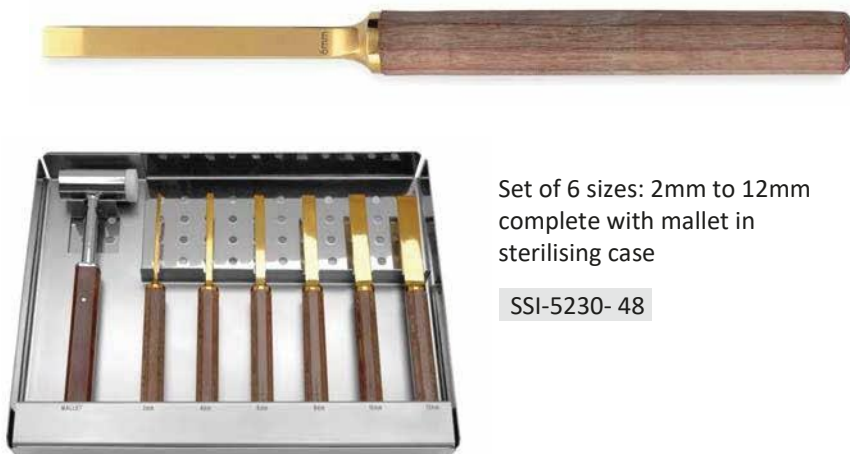

Set of 6 sizes: 2mm to 12mm
complete with mallet in
sterilising case

SSI-5230- 48

OSTEOTOMES

Mini- Stille Osteotome

• 16cm/6¼" length

Straight	Width
SSI-7704-16	4mm
SSI-7706-16	6mm
SSI-7708-16	8mm



Stille (Swedish) Osteotome

• 20cm/8" length

Straight	Width
SSI-7706 - 20	6mm
SSI-7708 - 20	8mm
SSI-7710- 20	10mm
SSI-7712- 20	12mm
SSI-7715- 20	15mm
SSI-7720 - 20	20mm
SSI-7725 - 20	25mm
SSI-7730 - 20	30mm



Hibbs Osteotome with thin blade

• 20cm/8" length
• Extra thin blade

Straight	Width	Curved	Width
SSI-7804- 20	4mm	SSI-7904- 20	4mm
SSI-7806- 20	6mm	SSI-7906- 20	6mm
SSI-7808- 20	8mm	SSI-7908- 20	8mm
SSI-7810- 20	10mm	SSI-7910- 20	10mm
SSI-7812- 20	12mm	SSI-7912- 20	12mm
SSI-7815- 20	15mm	SSI-7915- 20	15mm
SSI-7820- 20	20mm	SSI-7920- 20	20mm
SSI-7825- 20	25mm	SSI-7925- 20	25mm
SSI-7830- 20	30mm	SSI-7930- 20	30mm



Smith Petersen Osteotome

• 20cm/8" length

	Width
SSI-7610- 20	10mm
SSI-7615- 20	15mm
SSI-7620- 20	20mm
SSI-7625- 20	25mm
SSI-7630- 20	30mm



Email: sheffieldsurgicalinstruments@gmail.com
Web: www.sheffieldsurgicalinst.com

OSTEOTOMES

Mini-Lexer Osteotome

- 18cm/7" length
- Tufnol handle

SSI-5250 - 48 Set of 5 sizes:
2mm to 10mm

	Width
SSI-5250 - 02	2mm
SSI-5250 - 04	4mm
SSI-5250 - 06	6mm
SSI-5250 - 08	8mm
SSI-5250 - 10	10mm



Lexer Osteotome

- 22cm/8½" length
- Tufnol handle

	Width
SSI-7207- 22	7mm
SSI-7210- 22	10mm
SSI-7215- 22	15mm
SSI-7220- 22	20mm
SSI-7225- 22	25mm



Dahmen Osteotome

- 30cm/12" length
- Tufnol handle



	5mm
	10mm
	15mm
	20mm
	25mm
	30mm

	Straight	Width
	SSI-7105- 30	5mm
	SSI-7110- 30	10mm
	SSI-7115- 30	15mm
	SSI-7120- 30	20mm
	SSI-7125- 30	25mm
	SSI-7130- 30	30mm

	Angled	Width
	SSI-7305- 30	5mm
	SSI-7310- 30	10mm
	SSI-7315- 30	15mm
	SSI-7320- 30	20mm
	SSI-7325- 30	25mm
	SSI-7330- 30	30mm

OSTEOTOMES & GOUGES

Box Chisel

- 29cm/13½" length
- For preparation of the proximal femur
- 31mm width x 6mm

SSI-7031-29



Pelvic Osteotome

- 30cm/12" length
- Tufnol handle
- Angled shaft

15mm width

SSI-7015-30

20mm width

SSI-7020-30



Chisel with Interchangeable Blades

- 20cm/8" length
- Tufnol handle
- Very thin blades

SSI-0790-20

Complete set with 4 blades* & key



Blade Width

SSI-0792-05	5mm*
SSI-0793-08	8mm
SSI-0793-10	10mm*
SSI-0793-12	12mm
SSI-0794-15	15mm*
SSI-0795-25	25mm*

Capener Lamina Gouge

- 23cm/9" length
- Cranked shaft

Width

SSI-6506-23	6mm
SSI-6508-23	8mm
SSI-6511-23	11mm
SSI-6516-23	16mm



BONE CURETTES

Volkman Curette

- 22cm/8¾" length
- Double ended

	Size
SSI-8401- 22	Small
SSI-8402- 22	Medium
SSI-8403- 22	Large

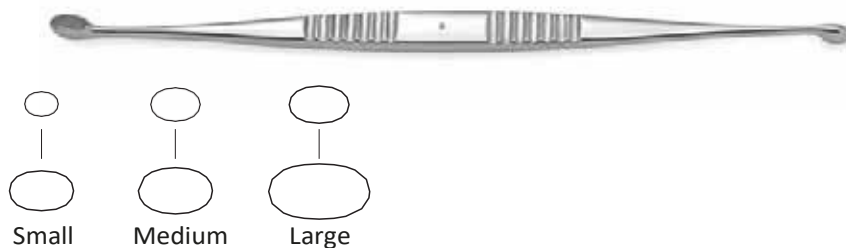

Muller Curette with Tufnol Handle

- 27cm/9¾" length
- Tufnol handle



Charnley Bone Curette

- 37cm/15" length
- T-handle



Charnley Ring Curette

- 37cm/15" length
- Double sided
- Serrated cutting edge
- T-handle



Email: sheffieldsurgicalinstruments@gmail.com
 Web: www.sheffieldsurgicalinst.com

HIP REVISION INSTRUMENTS

Cup Extraction Chisel

- 32cm/12½" length
- Curved 7mm tip
- Metal strike plate
- Tufnol handle



SSI-6507-32

Bayonet Gouge

- 32cm/12½" length
- Metal strike plate
- Tufnol handle
- 8mm width



SSI-6508-32

Swan Necked Gouge

- 28.5cm/11" length
- 25mm width



SSI-6525-28

Cement Gouge

- 34.5cm/13½" length



9mm width

SSI-6509-34

11mm width

SSI-6511-34

Cement Chisel Angled 15°

- 35.5cm/14 length
- 9mm tip



SSI-6109-35



HIP REVISION INSTRUMENTS

Cement Osteotome

- 30cm/12" length
- Tufnol handle with strike plate



Cement Splitting Osteotome

- 30cm/12" length
- Tufnol handle with strike plate
- Guarded blade



Straight Cement Gouge

- 30cm/12" length
- Tufnol handle with strike plate



Bayonet Cement Rasp

- 52cm/20½" length
- Tufnol handle

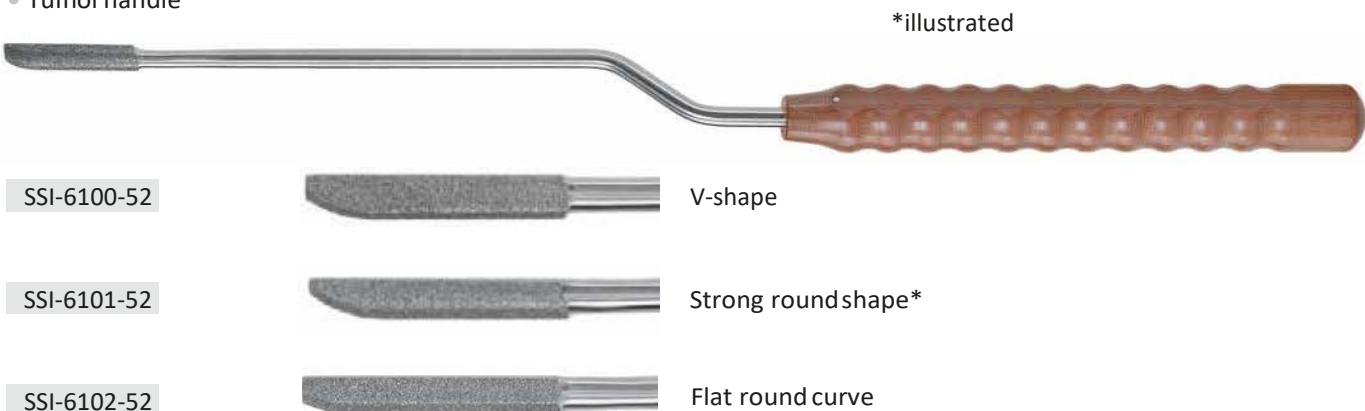

HIP REVISION INSTRUMENTS

Bayonet Cement Chisel

40cm/15¾" length

Tufnol handle with strike plate



Bayonet Cement Splitting Osteotome

- 40cm/15¾" length
- Tufnol handle with strike plate
- Guarded blade



Bayonet Cement Gouge

- 40cm/15¾" length
- Tufnol handle with strike plate



Bayonet Cement Gouge

- 40cm/15¾" length
- Tufnol handle with strike plate



HIP REVISION INSTRUMENTS

Malleable Cement Probe

- 38cm/15" length
- For probing the Femur



SSI-6900-38



Cement Plug Extractor

- 48cm/19" length
- T-handle
- For extraction of cement plug



Thread Dia.

SSI-6807-48	7mm
SSI-6809-48	9mm
SSI-6811-48	11mm



Used with a slotted mallet

Retrograde Cement Chisel

- 50cm/19¾" length
- Tufnol T-handle
- Striking plate



Width

SSI-6805-50	5mm
SSI-6807-50	7mm
SSI-6810-50	10mm



Slotted Mallet



SSI-6850-00

Cement Extraction Hook

34.5cm/14" length

SSI-6905-34

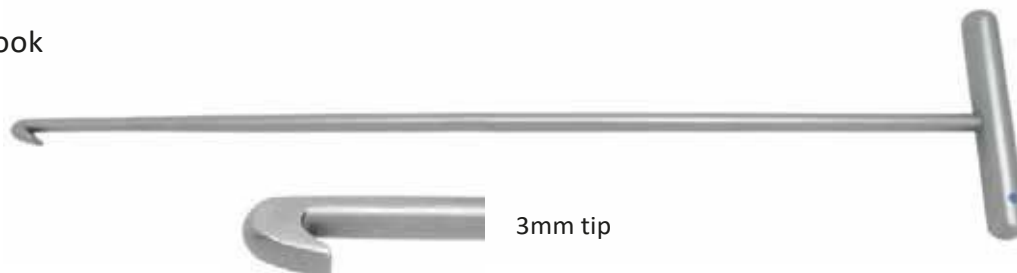

3mm tip

HIP REVISION INSTRUMENTS

Cement Twist Drill Long

- 40cm/15 ¾" length



Diameter

SSI-1400-06	6mm
SSI-1400-08	8mm
SSI-1400-10	10mm

Fine Cement Duckbill Grasping Forceps

- 35cm/14" shaft length
- Fine jaws



SSI-6901-35

Heavy Cement Grasping Forceps

- 26cm/10" shaft length
- Serrated jaws 6mm width



SSI-6902-26

HIP REVISION INSTRUMENTS

Femoral Head Extractor

- 23cm/9" length
- Tufnol handle

SSI-6916-23



Moore Femoral Head Extractor

- 20.5cm/8" length
- Metal handle

SSI-6914-20



Joint Capsule Clamp

- 21cm/8 1/4" length
- 25mm jaw length

SSI-6995-21



Joint Capsule Scissors

- 25cm/9 3/4" length
- Angled blades

SSI-6910- 25



HIP JOINT INSTRUMENTS

Femoral Head Impactor

- 20cm/8" length
- Nylon head

SSI-6918-20



McGoey Bone Punch

- Double ended

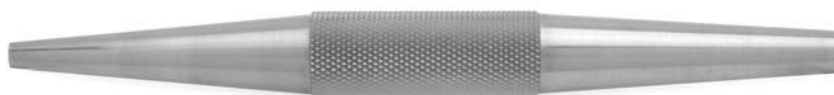

* illustrated

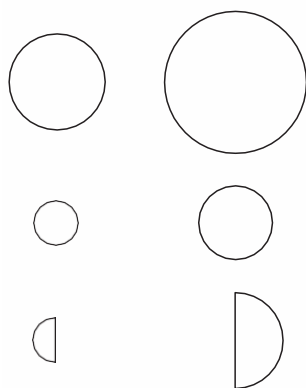

No 1. 13mm x 19mm Ø SSI-6913-19 Large size

No 2. 6mm x 10mm Ø SSI-6906-10 *Small size

No 3. 6mm x 13mm Ø SSI-6906-13
With flats

Hardinge Cement Restrictor

- 33.5cm/13¼" length
- Graduated shaft



SSI-6920-33

Femoral Pusher

- Square ended

SSI-6925-20

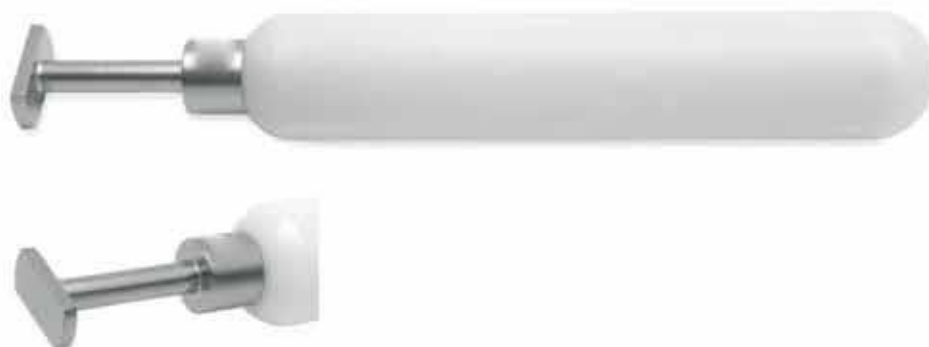

PLIERS & WIRE CUTTERS

Universal Fine Pliers and Cutters

- 15cm/6" length

SSI-7640-15

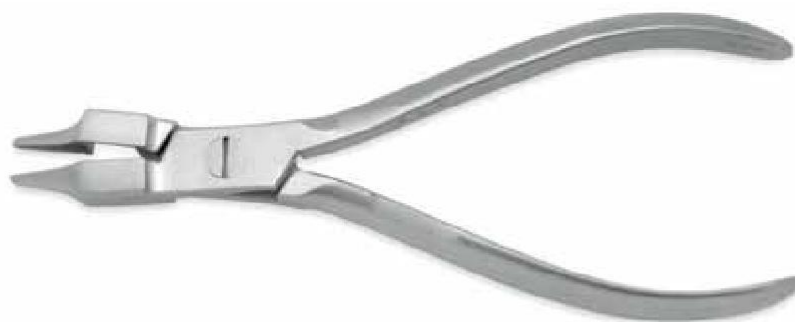
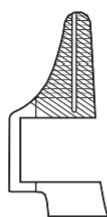

Slim & Square Ended Wire Pliers

- 19cm/7½" length

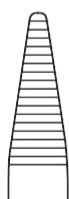

Slim Nose

SSI-7645-19

Serrated jaw



Square Ended*

SSI-7644-19



*illustrated

Pliers for Screw Removal

- 20cm/8" length

SSI-5701-20



Muller Claus Wire Pullers

- 18cm/7" length
- Double action
- Tungsten jaws

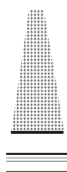

2mm Jaws

SSI-818E18



4mm Jaws

SSI-820E18



6mm Jaws

SSI-821E18



Email: sheffieldsurgicalinstruments@gmail.com
 Web: www.sheffieldsurgicalinst.com

PLIERS & WIRE CUTTERS

Muller Claus Wire Cutters

- 16cm/6" length
- Tungsten carbide edges
- Cuts wire up to 1.6mm Ø

SSI- 810E16



Muller Claus Wire Cutters

- Tungsten carbide edges

SSI- 810E18

- 18cm/7" length*
- Cuts wire up to 2mm Ø

SSI- 800E22

- 22cm/8¾" length
- Cuts wire up to 3mm Ø



*illustrated

End Wire Cutters

- 18cm/7" length
- Tungsten carbide edges
- Cuts wire up to 1.7mm Ø

SSI- 816E18



Bolt Cutters with dismantable arms

- Max. cap 6.3mm pins

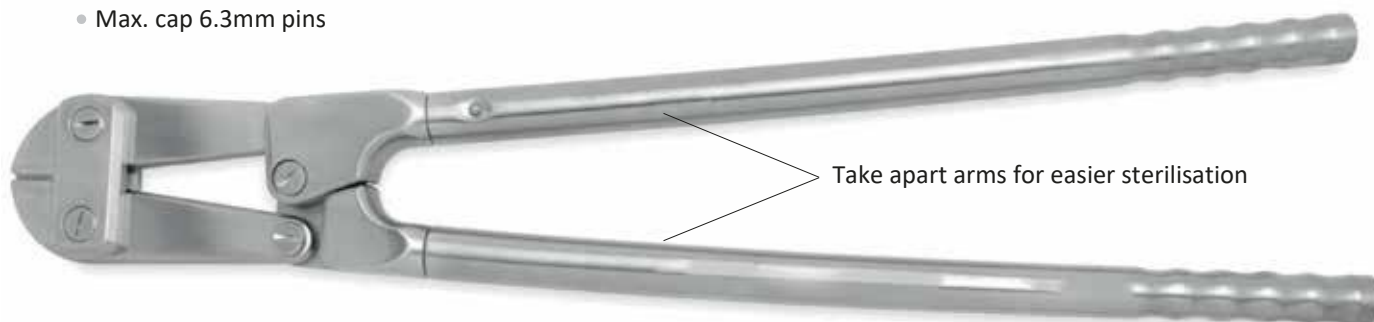

Take apart arms for easier sterilisation

SSI-500-585

- Must be used in conjunction with a Rod Holder. Ordering Code: 200-675-200

WIRE CUTTERS

Combined Wire Cutters & Pliers

- 18cm/7" length
- Suitable for wires up to 1.6mm \varnothing
- Parallel closing jaws

SSI-512-185



Wire Cutters with T/C Jaws

- 24cm/9½" length
- Double action
- Cuts plates & wires up to 2.7mm \varnothing

SSI-7644-24



'Power Cut' Wire Cutters

- 20cm/8" length
- Cutting inserts are T/C and can be replaced
- Cuts wires up to 3mm \varnothing

SSI-7645-20



LOCKING PLIERS

Needle Nosed Locking Pliers



Code	Length	Size
SSI-514-220	22cm/8¾"	Small
SSI-515-250	25cm/9¾"	Medium
SSI-516-300	30cm/11¾"	Large

- A very useful instrument for orthopaedic surgery allowing the surgeon to securely clamp on to wires and implants.



Slap Hammer attachment combined

Code	Length	Weight
SSI-400-350	35cm/13¾"	400g
SSI-700-350	35cm/13¾"	700g

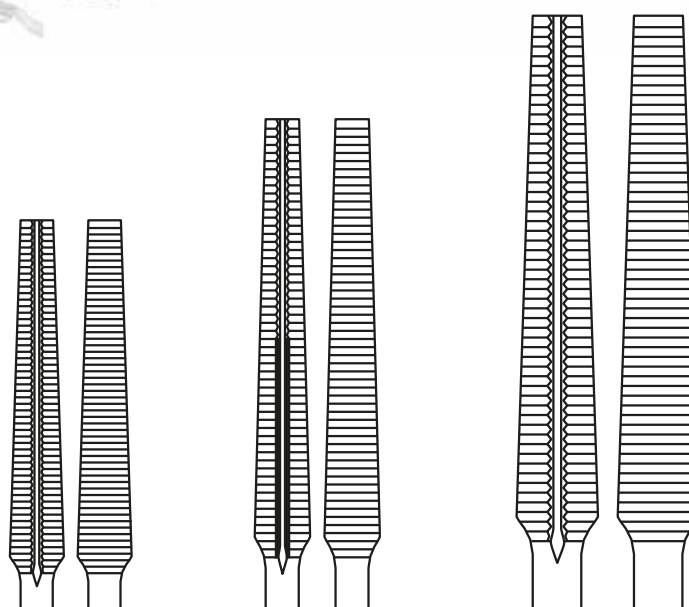

22cm/8¾" Small

25cm/9¾" Medium

30cm/11¾" Large

Orthopaedic Locking Pliers

- Hardened jaws



Code	Length	Size
SSI-511-180	18cm/7"	Small
SSI-511-200	20cm/8"	Medium
SSI-511-240	24cm/9½"	Large



18cm/7" Small 20cm/8" Medium 24cm/9½" Large

PIN INTRODUCERS

Kirschner Wire Introducing T-Handle

- 12cm/4¾" length
- 1.5mm Ø wires

SSI-5015-12



Steinmann Pin Introducer T-Handle

- 14cm/5½" length
- 0.5mm - 8mm Ø pins
- With Jacobs chuck & key

SSI-5502-14



Steinmann Pin Introducer T-Handle

- 14cm/5½" length
- 0.7mm - 6mm Ø pins
- Universal chuck

SSI-5507-14



MISC

Bone Mill

- Table mounted with crank handle
- With removable cutting drum

SSI-6001-00

For grinding bone chips used for bone graft procedures.

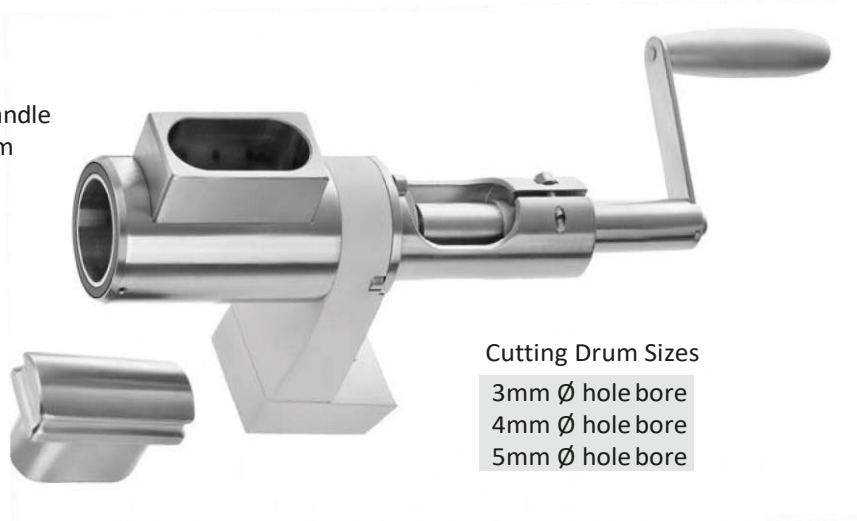

Cutting Drum Sizes
 3mm Ø hole bore
 4mm Ø hole bore
 5mm Ø hole bore

Wire Passing Guide

- 21cm/8¼" length



Used for passing wire around bones.

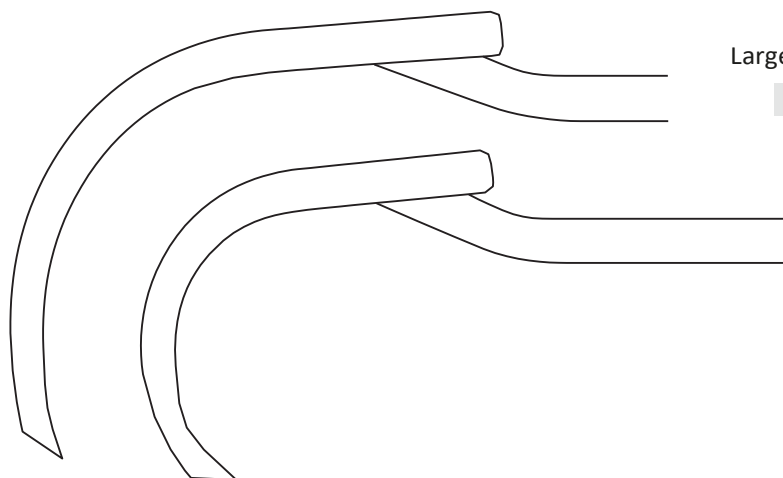

Large curve 70mm Ø

SSI-6105-21

Small curve 45mm Ø

SSI-6104-21

Bone Awl

Straight with eye

	Diameter	Length
SSI-5602-12	2.0mm	125mm
SSI-5602-13	2.4mm	130mm
SSI-5602-14	2.8mm	145mm
SSI-5602-15	3.2mm	160mm
SSI-5602-16	3.6mm	165mm
SSI-5602-17	4.0mm	175mm



Email: sheffieldsurgicalinstruments@gmail.com
 Web: www.sheffieldsurgicalinst.com

SCREW DRIVERS

Slotted Head

- 17cm/6¾" length
- For head screws 2.7mm - 4.0mm

SSI-7014-17



Long Slotted Head

- 25cm/10" length
- For head screws 2.7mm - 4.0mm

SSI-7014-25



Phillips Head

- 25cm/10" length
- For small Phillips head screws 6mm

SSI-7015-25

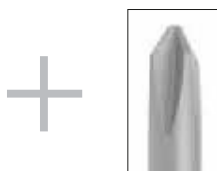

Cross Slotted Head

- 25cm/10" length
- For cross slot screws 6mm

SSI-7016-25

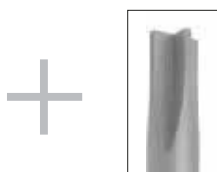

SCREW DRIVERS

Hexagonal Head

- 25cm/10" length
- For hexagonal head screws 2.7mm - 4.0mm

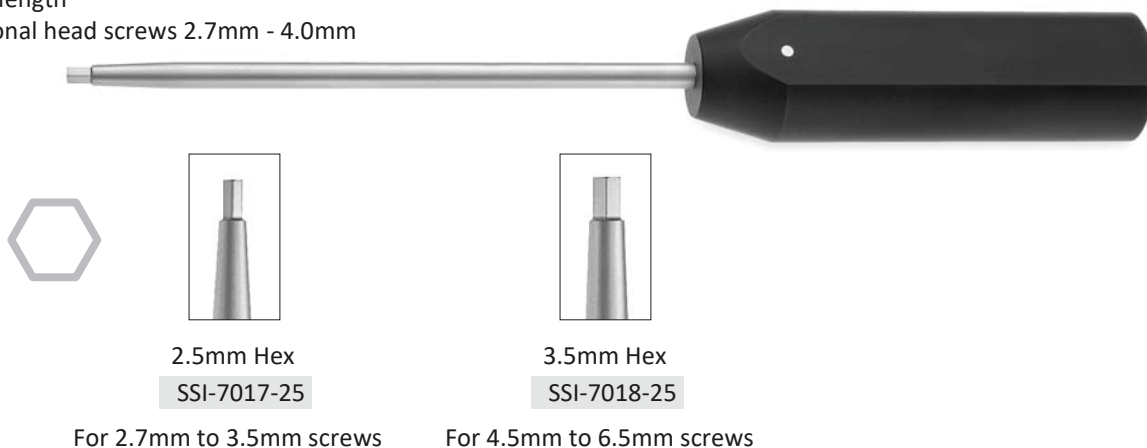

2.5mm Hex
SSI-7017-25

For 2.7mm to 3.5mm screws

3.5mm Hex
SSI-7018-25

For 4.5mm to 6.5mm screws

Screwdriver Handle

- To fit shafts with quick lock attachment

SSI-7020-02



Screwdriver Handle Small

- To fit shafts with quick lock attachment

SSI-7020-01



Shaft with Quick Lock Fitting

- Hexagonal tip



Shaft	Diameter
SSI-7021-00	2.5mm
SSI-7022-00	3.5mm

DISSECTORS

Howarth Elevator

21.5cm/8½" length



SSI-9207-21

MacDonald Elevator/Dissector



Size

SSI-7105-19	19cm/7 ½"
SSI-9206-23	23cm/9"

Watson Cheyne Dissector



Length

SSI-7203-18	18cm/7"
SSI-9203-23	23cm/9"
SSI-9203-25	25.5cm/10"

Freers Elevator/Dissector

• 18.5cm/7¼" length



SSI-7602-18

Swedish Dissector

• 18cm/7" length



SSI-9201-18

MEASURING INSTRUMENTS

Stainless Steel Measuring Ruler

Code	Length
SSI-5005-15	15cm/6"
SSI-5005-30	30cm/12"



Measuring Caliper

- 25cm/10" length
- Measuring range 0-50mm

SSI-7334-20



Vernier Caliper

- 22.5cm/9" length
- Measuring range 15cm

SSI-7338-00



Depth Gauge

- Measuring depth up to 50mm

SSI-7350-00



Depth Gauge

- Measuring depth up to 70mm

SSI-7370-00



Direct Reading Depth Gauge

- 23cm length
- Measuring depth up to 40mm

SSI-7333-10





SHEFFIELD

SURGICAL INSTRUMENTS

SERVING SURGICAL WORLD SINCE 1992



**SHOULDER SURGERY
INSTRUMENTS**

BONE TUNNELLING & SUTURE PASSING

Penetrating Bone Gouge

- 22cm/8 ³/₄" length
- 3mm wide tip

SSI-0804- 22



Percussion Bone Awl

- 22cm/8 ³/₄" length
- Curved, with metal handle

SSI-0805- 22



Penetrating Bone Awl

- 18cm/7" length
- Tufnol handle

SSI-0806 -18



Crochet Hook Suture Passer

- 18cm/7" length
- Tufnol handle

SSI-0807-18



Suture Passer

- 18/7"cm length
- Tufnol handle
- With hole in tip

SSI-0808 -18



The Bone Awls and Suture Passers are used to place sutures along the edge of the Glenoid Rim.

BONE PEFORATING FORCEPS & ELEVATORS

Glenoid Perforating Forceps Light Curve

- 17cm/6 ³/₄" length
- Light curve

SSI-1858-17

For perforating holes in the Glenoid Rim.



Glenoid Perforating Forceps Strong Curve

- 17cm/6 ³/₄" length
- Strong curve

SSI-1859-17



Kolbel Glenoid Elevator

- 30cm/12" length
- 15mm width
- Curved
- Double prong

SSI-0596-15



Kolbel Glenoid Elevator

- 30cm/12" length
- 20mm width
- Curved
- Double prong

SSI-0598-20



Posterior Glenoid Elevators

- Curved tip to sit on posterior rim of Glenoid
- For Posterior Retraction of the Humeral Head



Width tip

SSI-0575-08	8mm
SSI-0575-12	12mm
SSI-0575-20	20mm

Email: sheffieldsurgicalinstruments@gmail.com
 Web: www.sheffieldsurgicalinst.com

HUMERAL HEAD RETRACTORS

Skid Lever

- 28cm/11" length
- Double ended
- 20mm and 30mm blade widths

SSI-0589- 23



Humerus Head Retractor

- 18cm/7" length
- Strongly curved
- Double blunt prongs

SSI-0592-18



Bhattman Humerus Head Retractor

- 25cm/9 ³/₄ length
- 30mm width
- Double prong

SSI-0590- 30



ELEVATORS

Fukuda Humerus Head Retractor

- 22.5cm/9" length
- Fenestrated



*illustrated

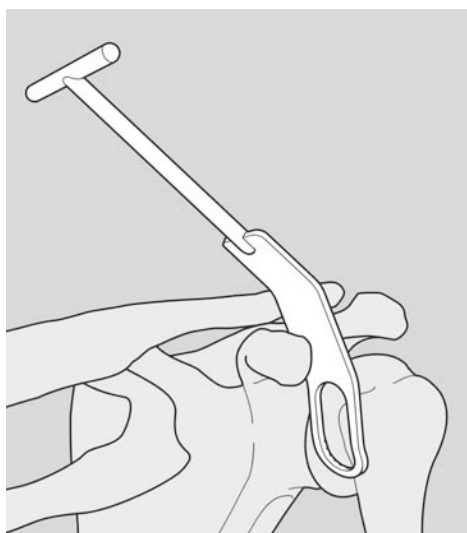

	width
SSI-0594-32	32mm
SSI-0594-22	35mm*
SSI-0594-37	37mm

Darrach Acromial Elevators



*illustrated

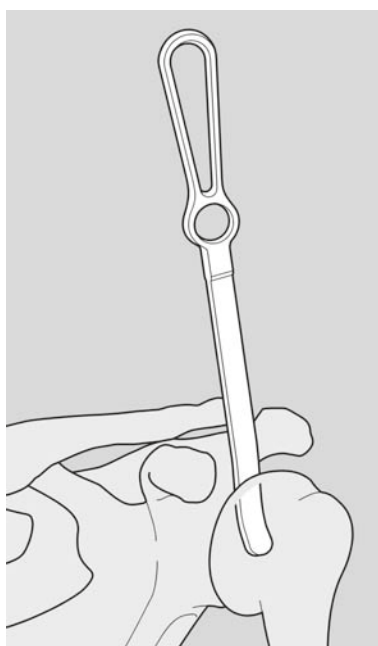

Small 9mm width, 26cm/10 1/4" length

SSI-0599-09



Medium 12mm width, 26cm/10 1/4" length

SSI-0599-12



Large 16mm width, 26cm/10 1/4" length*

SSI-0599-16



Extra Large 25mm width, 36cm/14 1/4" length

SSI-0599-25

Set of 4 Elevators

SSI-0599-00

SUB-ACROMION SPREADER

Subacromion Spreader

- 19cm/7 1/2" length
- Small size

SSI-6551 -19 left side ring*

SSI-6552 -19 right sidering



illustrated*

Subacromion Spreader

- 25cm/9 3/4" length
- Large size

SSI-6553-25 left side ring*

SSI-6554-25 right side ring



illustrated*

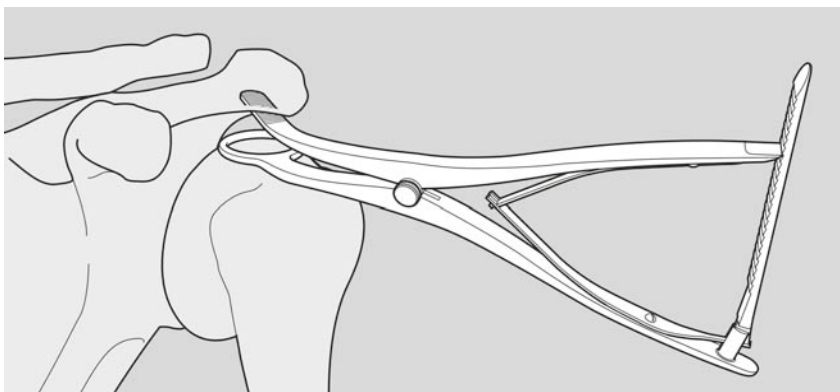

These spreaders are used when access is required to the subacromion area. The spreaders distract the humeral head from the acromion.

SOFT TISSUE & MUSCLE RETRACTORS

Kolbel Tissue & Muscle Spreader

- 18cm/7" length
- Straight single blunt prongs

SSI-6442 -18



Kolbel Tissue & Muscle Spreader

- 18cm/7" length
- Angled single blunt prongs

SSI-6443 -18



Kolbel Tissue & Muscle Spreader

- 18cm/7" length
- Angled double blunt prongs

SSI-6441-18



Capsule Spreader

- 18cm/7" length
- Single blunt prongs
- 90° Angled

SSI-6445 -18



SOFT TISSUE RETRACTORS

Kolbel Shoulder Retractor

- With 3 pairs of detachable blades
- 23cm/9" length

SSI-1062- 23

Complete set with 3 pairs of blades and retractor frame



SSI-1062- 00

Retractor frame only



SSI-1063- 36
Small blade



SSI-1064- 53
Medium blade



SSI-1065- 68
Large blade

Browne Deltoid Retractor

- 27cm/10 1/2 length
- 60mm x 65mm blade
- Cupped blade

SSI-0500- 27

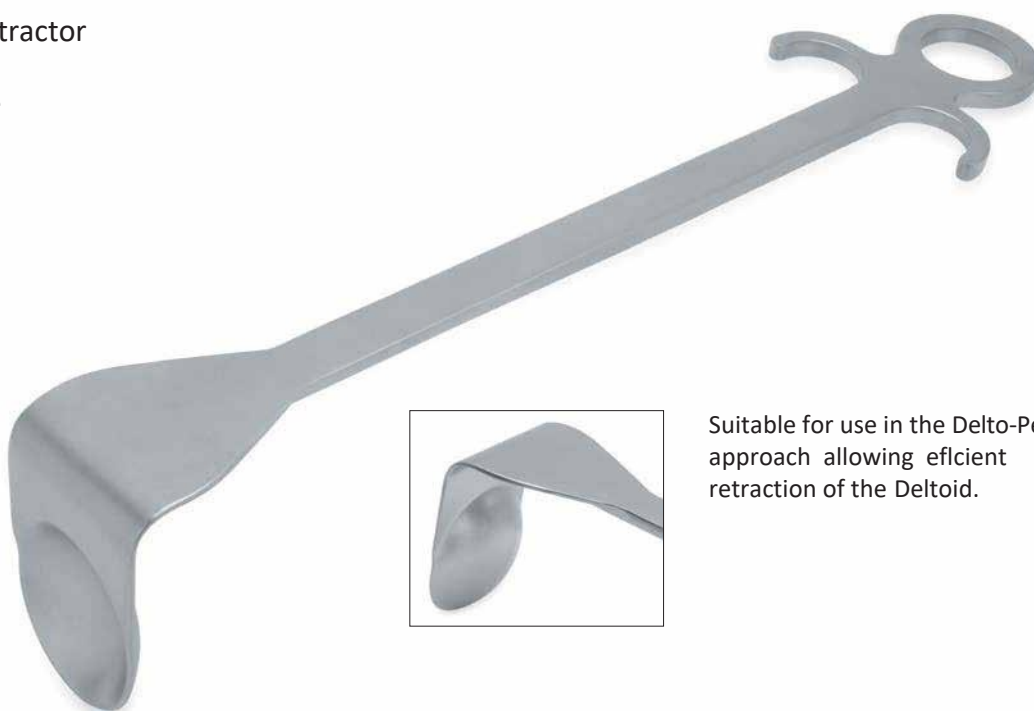

Suitable for use in the Delto-Pectoral approach allowing efficient retraction of the Deltoid.

SHOULDER RETRACTORS

Titanium Bladed Shoulder Retractor

Complete set with:

- 1x Frame
- 2x Blade holders
- 2 Sets of Titanium blades
- Sterilizing container

SSI-1007- 00



Frame with Articulating Joints

- Quick lock + unlock for blades
- Maximum spread 10cm

SSI-1088- 00



Blade Holder

SSI-1009- 00

Titanium Retractor Blades

- 30 angled
- Small blade size 22mm x 55mm
- Large blade size 22mm x 65mm



MISCELLANEOUS

Richardson Retractor

- 20mm width
- 24cm/9 ½ length

SSI-2054- 20



Richardson Retractor

- 28mm width
- 24cm/9 ½ length

SSI-2053- 28



Kolbel Tenectomy Ronguer

- 18cm/7" length
- Jaws 3mm bite
- Strong curved

SSI-1258 -19



Kolbel Bone Nibblers

- 18cm/7" length
- Jaws 5mm bite
- Light curved

SSI-1256 -19



Mallet

- 24cm/9 ½ length
- Tufnol handle
- 480 grams

SSI-0900- 24



Chisel with 4 Interchangeable Blades

- 20cm/8" length
- Tufnol handle
- Complete with blade sizes:
5mm, 10mm, 15mm, 25mm & key

SSI-0790- 20





SHEFFIELD SURGICAL BUILDING
Wazirabad Road, Ugoki, Sialkot-51310 Pakistan.

WhatsApp # +92-333-1400682
Email: sheffieldsurgicalinstruments@gmail.com
Email: info@sheffieldsurgicalinst.com
Web: www.sheffieldsurgicalinst.com

