

Surgical Instruments Catalogue
Chirurgische Instrumente Katalog
Instruments chirurgicaux catalogue

GYNECOLOGY INSTRUMENTS



Manufacturer & Exporters of Surgical Instruments



**SHEFFIELD
SURGICAL
INSTRUMENTS**

Quality

Instruments

Since 1992



Quality

Instruments

Since 1992

Manufacturer & Exporters of Surgical Instruments

Sheffield Surgical Building, Wazirabad Road, Ugoki, Sialkot-51310 Pakistan.

Tell # +92-333-1400682

Email: sheffieldsurgicalinstruments@gmail.com

Email: info@sheffieldsurgicalinst.com

Web: www.sheffieldsurgicalinst.com



Kidney Stone Forceps

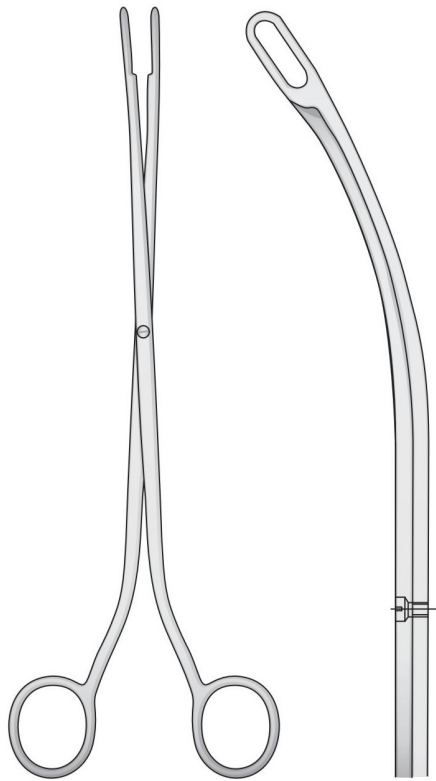

DESJARDINS
EB-11/EB-14
225 mm

Fig. 1



EB-11

Fig. 3



EB-13

Fig. 2



EB-12

Fig. 4



EB-14

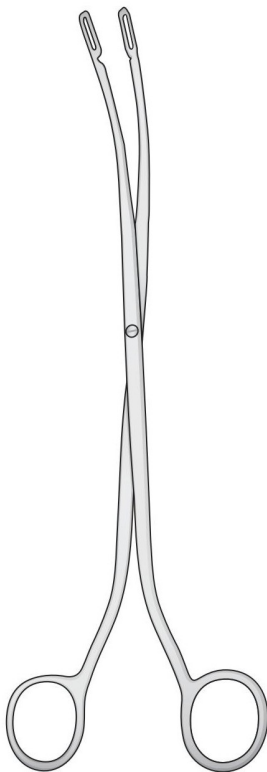

RANDALL
EB-36/EB-39
225 mm

Fig. 1

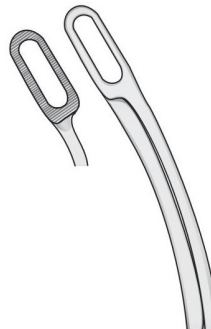

EB-36

Fig. 3



EB-38

Fig. 2



EB-37

Fig. 4



EB-39

Catheters Metal

Strumenti per tendere ed introdurre i cateteri
 Catheter introducing instruments
 Katheter-Einführungsinstrumente
 Mandrin pour introduire les sondes
 Instrumentos para introducir catéteres

Per uomini
 For men
 Für Männer
 Pour hommes
 Para hombres

Charr.

EA-60	8
EA-62	10
EA-63	12
EA-64	14
EA-65	16
EA-66	18
EA-67	20

Per donne
 For woman
 Für Frauer
 Pour femmes
 Para mujeres

Charr.

EA-70	6
EA-72	8
EA-74	10
EA-76	12
EA-77	14
EA-78	16
EA-79	18

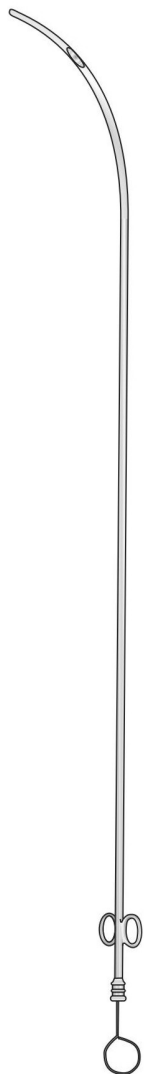

EA-60/EA-67
290 mm



EA-70/EA-79
160 mm

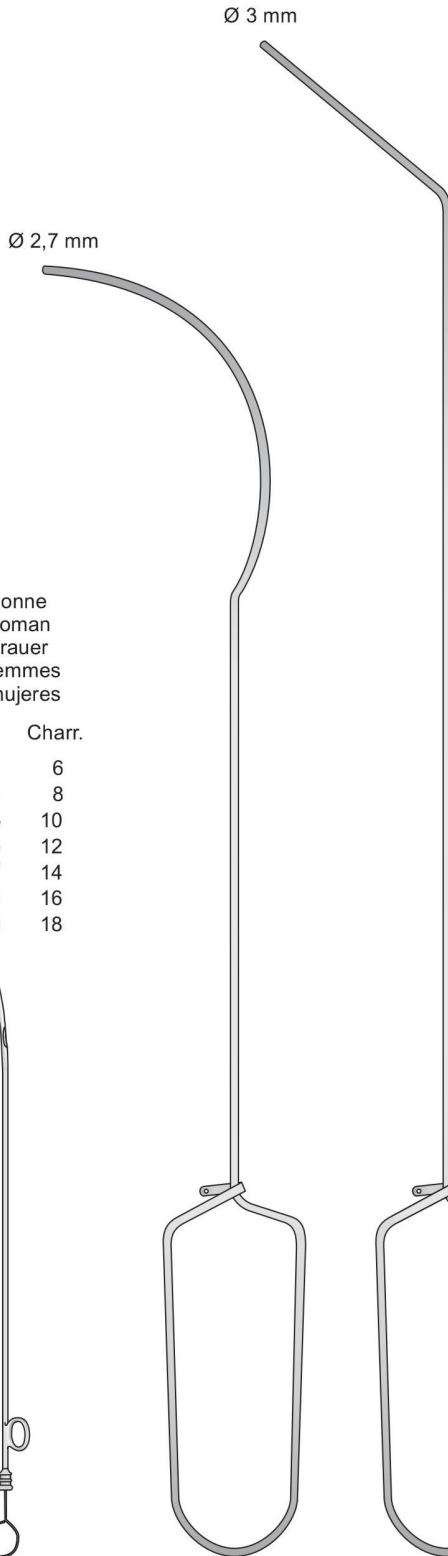

EA-90
365 mm

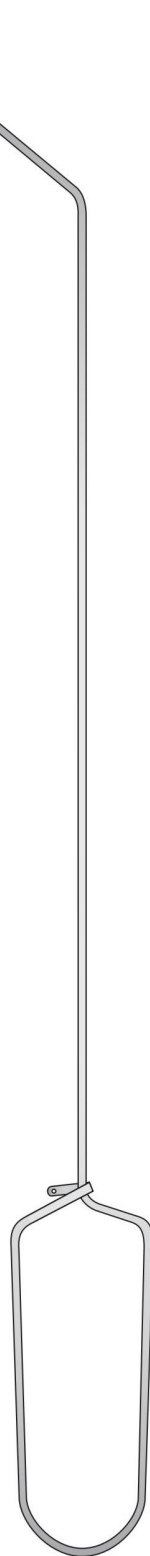

EA-91
410 mm

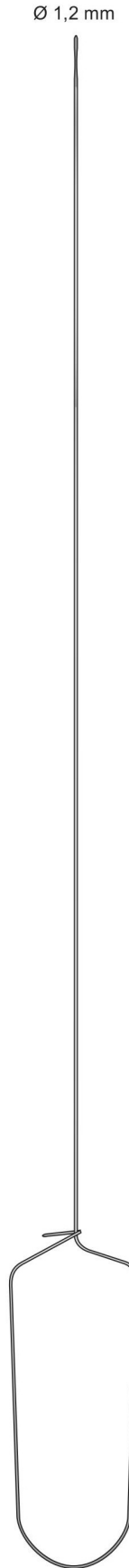

EA-93
460 mm

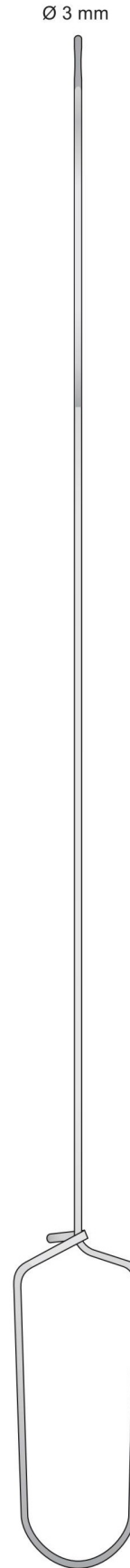

EA-92
460 mm



Gall Duct Dilators

- FB-321** - 190 mm - Ø 3 mm
- FB-322** - 190 mm - Ø 4 mm
- FB-323** - 190 mm - Ø 5 mm
- FB-324** - 190 mm - Ø 6 mm
- FB-325** - 190 mm - Ø 7 mm
- FB-326** - 190 mm - Ø 8 mm
- FB-327** - 190 mm - Ø 9 mm
- FB-328** - 190 mm - Ø 10 mm
- FB-329** - 190 mm - Ø 11 mm

- FB-331** - 300 mm - Ø 1 mm
- FB-332** - 300 mm - Ø 2 mm
- FB-333** - 300 mm - Ø 3 mm
- FB-334** - 300 mm - Ø 4 mm
- FB-335** - 300 mm - Ø 5 mm
- FB-336** - 300 mm - Ø 6 mm
- FB-337** - 300 mm - Ø 7 mm
- FB-338** - 300 mm - Ø 8 mm
- FB-339** - 300 mm - Ø 9 mm
- FB-340** - 300 mm - Ø 10 mm
- FB-341** - 300 mm - Ø 11 mm
- FB-342** - 300 mm - Ø 12 mm
- FB-343** - 300 mm - Ø 13 mm

FB-320

Set di 9 pezzi con custodia
 Set of 9 pieces in canvas pocket
 Satz à 9 Stück in Leinentuchtasche
 Jeu de 9 pièces dans une poche en toile
 Juego de 9 unidades en bolsa de tela

FB-330

Set di 13 pezzi
 Set of 13 pieces
 Satz à 13 Stück
 Jeu de 13 pièces
 Juego de 13 unidades

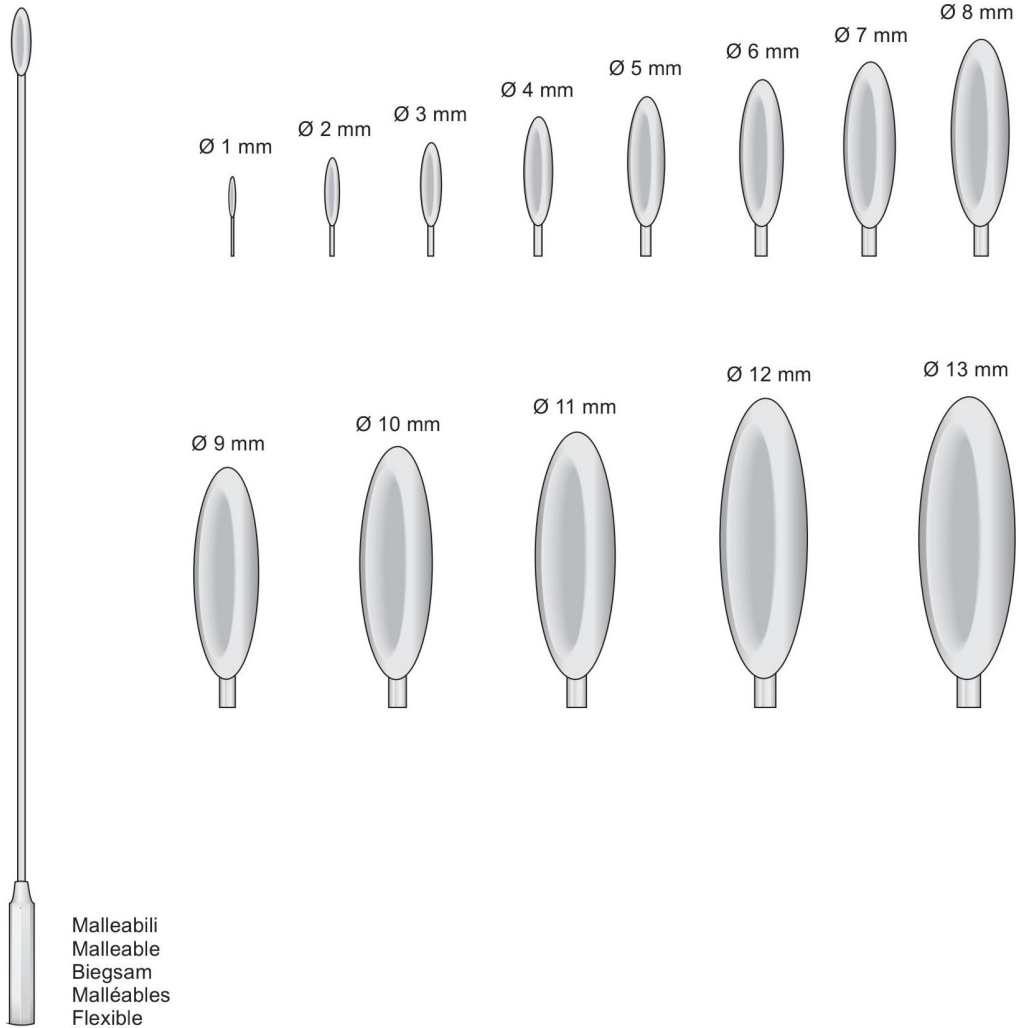

Malleabili
 Malleable
 Biigsam
 Malléables
 Flexible

BAKES
 FB-321/FB-343

Gall Duct Dilators



DITTEL
EB-251/EB-267
220 mm

	Charr.
EB-251	8
EB-252	9
EB-253	10
EB-254	11
EB-255	12
EB-256	14
EB-257	16
EB-258	18
EB-259	20
EB-260	22
EB-261	24
EB-262	25
EB-263	26
EB-264	27
EB-265	28
EB-266	29
EB-267	30

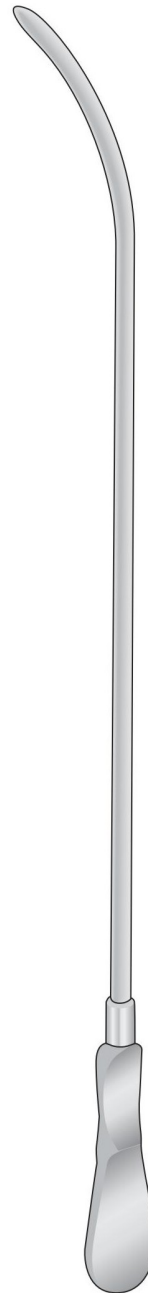

DITTEL
EB-201/EB-223
345 mm

	Charr.
EB-201	8
EB-202	9
EB-203	10
EB-204	11
EB-205	12
EB-206	13
EB-207	14
EB-208	15
EB-209	16
EB-210	17
EB-211	18
EB-212	19
EB-213	20
EB-214	21
EB-215	22
EB-216	23
EB-217	24
EB-218	25
EB-219	26
EB-220	27
EB-221	28
EB-222	29
EB-223	30



Gall Duct Dilators

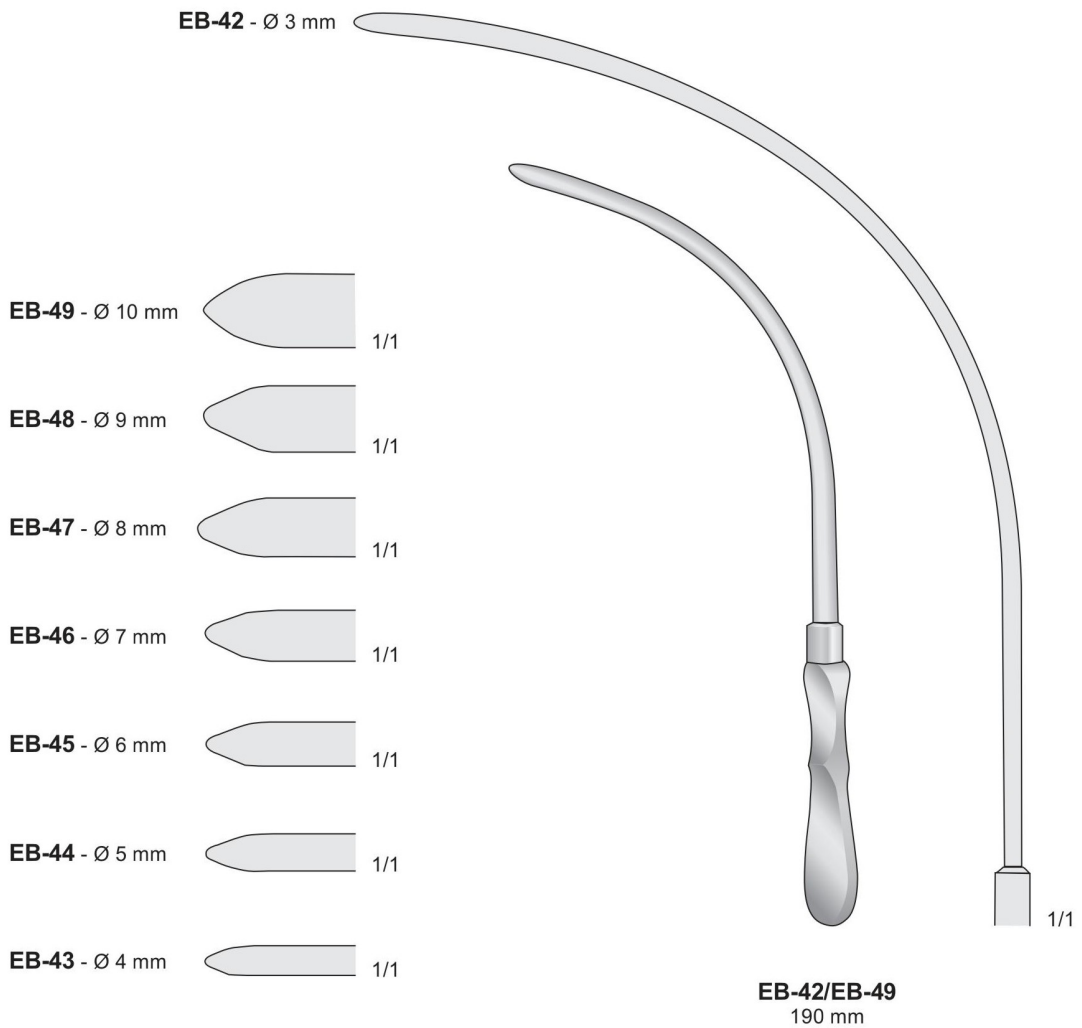

Gall Duct Dilators



EB-250

Set completo con 19 pezzi - Ch.12 / Ch.30
 Set complete with 19 pieces - Ch.12 / Ch.30
 Komplettsset mit 19 Stück - Ch.12 / Ch.30
 Set complet avec 19 pièces - Ch.12 / Ch.30
 Set completo con 19 piezas - Ch.12 / Ch.30

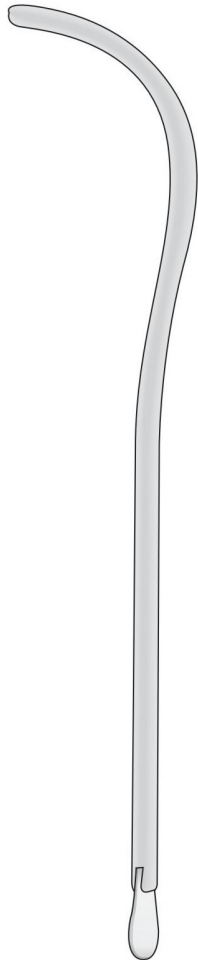

GUYON
EB-231/EB-249
 255 mm

	Ben.	Charr.
EB-231	24	12
EB-232	26	13
EB-233	28	14
EB-234	30	15
EB-235	32	16
EB-236	34	17
EB-237	36	18
EB-238	38	19
EB-239	40	20
EB-240	42	21
EB-241	44	22
EB-242	46	23
EB-243	48	24
EB-244	50	25
EB-245	52	26
EB-246	54	27
EB-247	56	28
EB-248	58	29
EB-249	60	30

Sonde per dotto biliare, Elastiche
 Gall Stone Probes, Elastic
 Gallensteinsonden, Federnd
 Explorateurs pour calculs biliaires, Élastiques
 Exploradores para cálculos biliares, Elásticos

Ø 4,3 mm



EB-18

Ø 6,0 mm



EB-19

Ø 7,0 mm



EB-20



DESJARDINS
EB-18/EB-20
 280 mm

Intestines and Urology

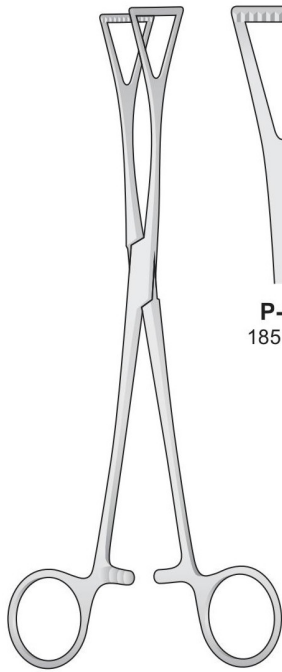

DUVAL
P-99/P-224

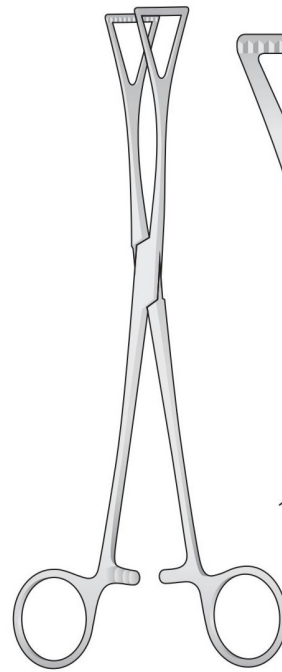
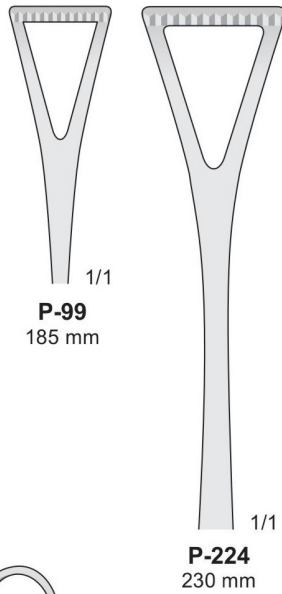

DUVAL-COLLIN
P-225/P-226

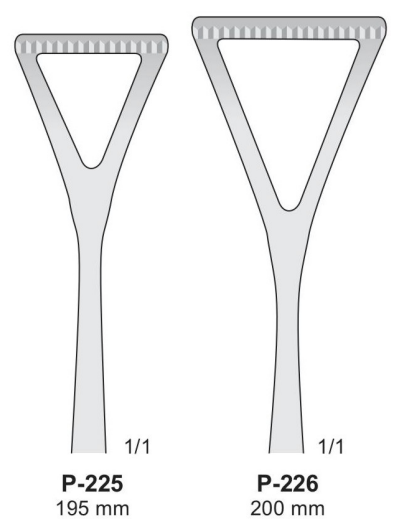

Pinze per peduncoli renali - Kidney pedicle clamp forceps - Nierenstielklemmen
Pincas-clamps pour pédicules rénaux - Pinzas-clamps para pedúncolos renales

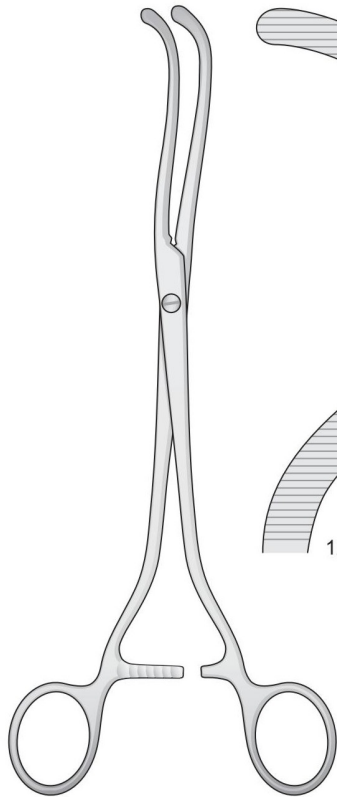

BRAUN
EB-30
245 mm

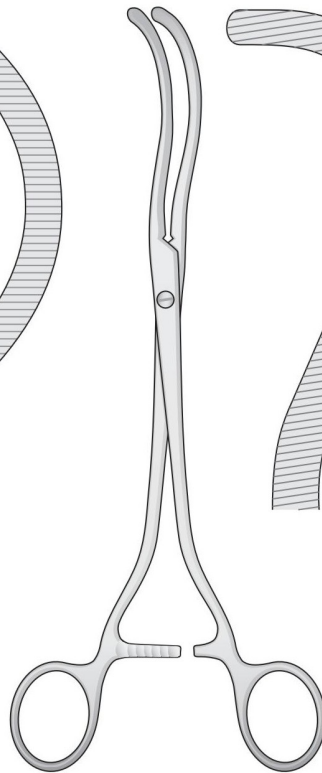
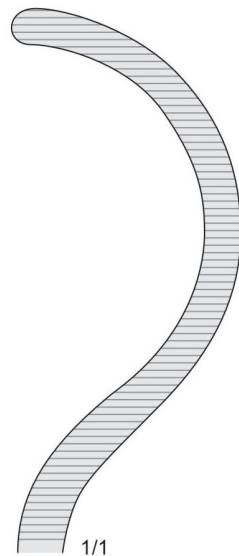

GUYON
EB-31
235 mm

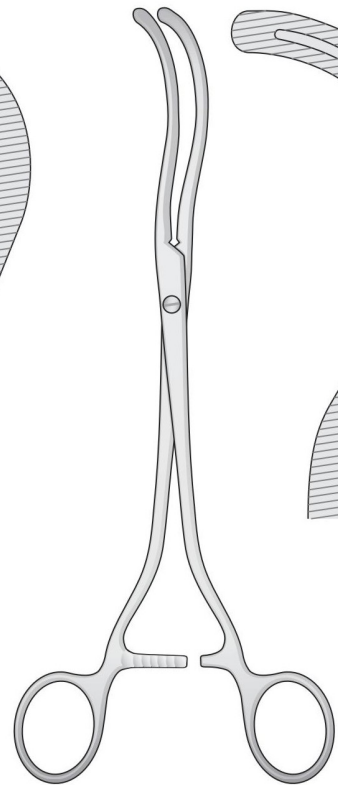
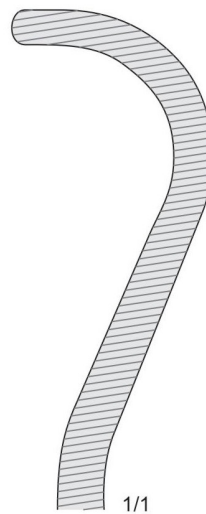

STILLE
EB-32
240 mm

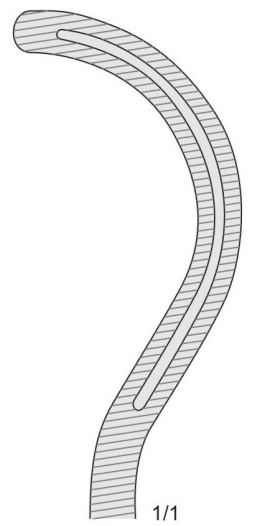

Kidney Pedicle Forceps

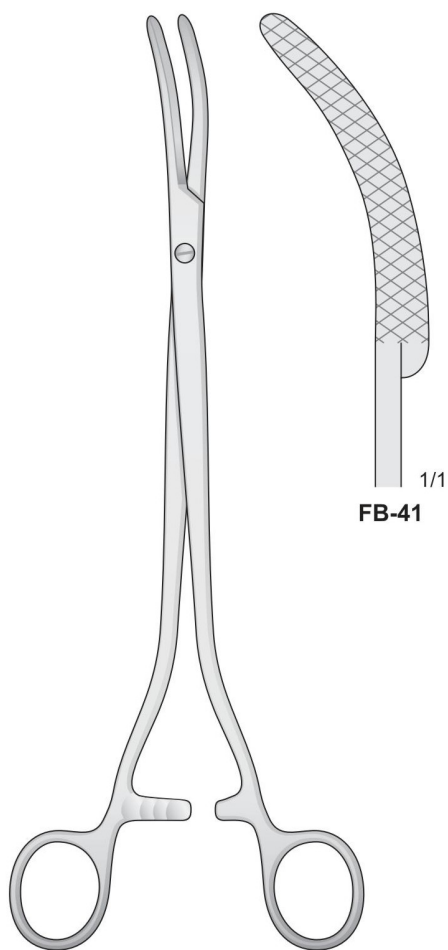

WERTHEIM
FB-41
260 mm

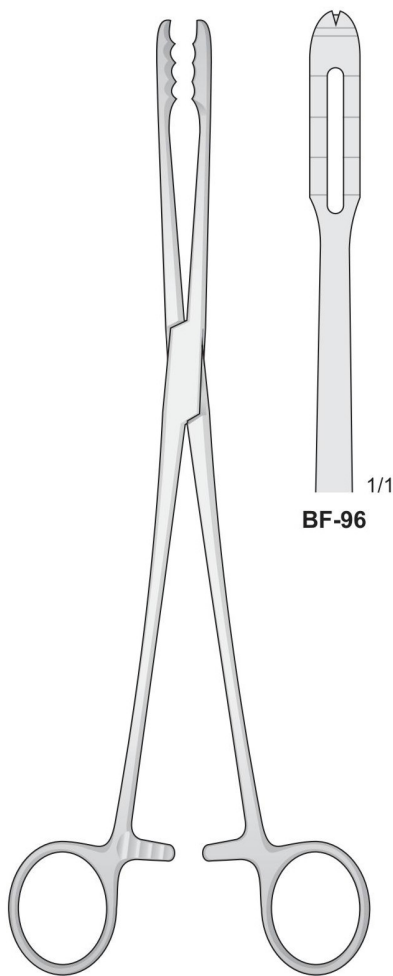

BF-96/BF-97
265 mm

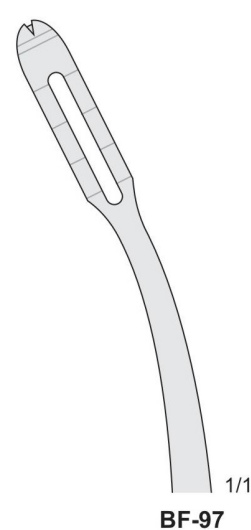

Kidney Pedicle Forceps

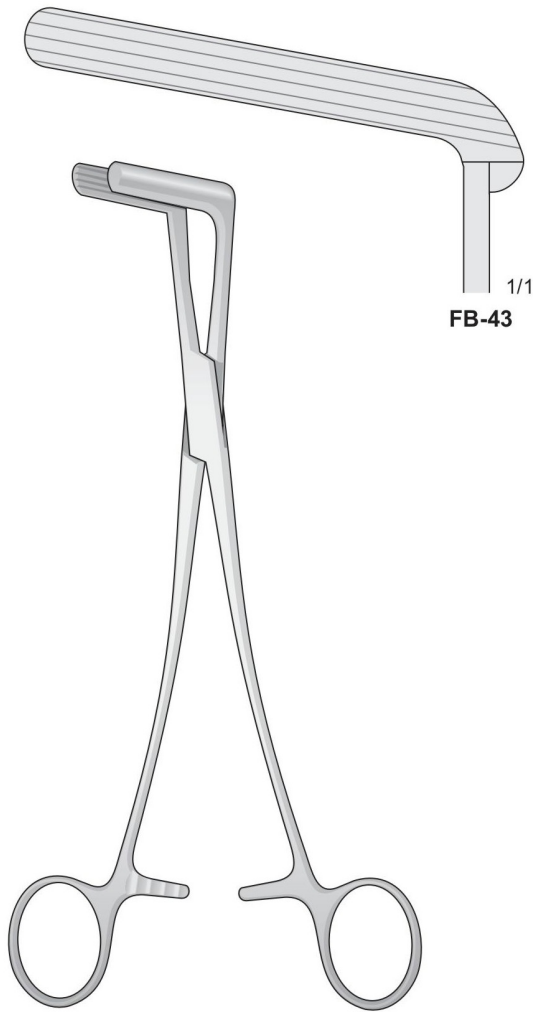

WERTHEIM
FB-43
235 mm

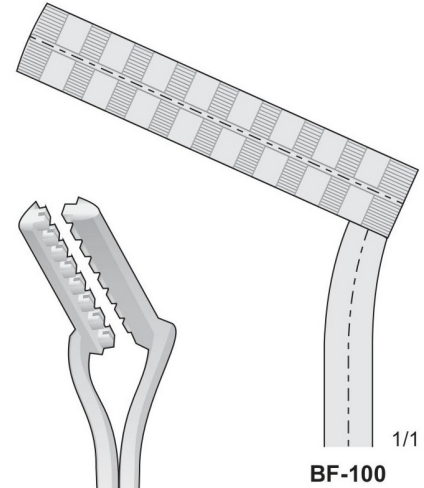

BF-100
280 mm

Placenta and Ovum Forceps

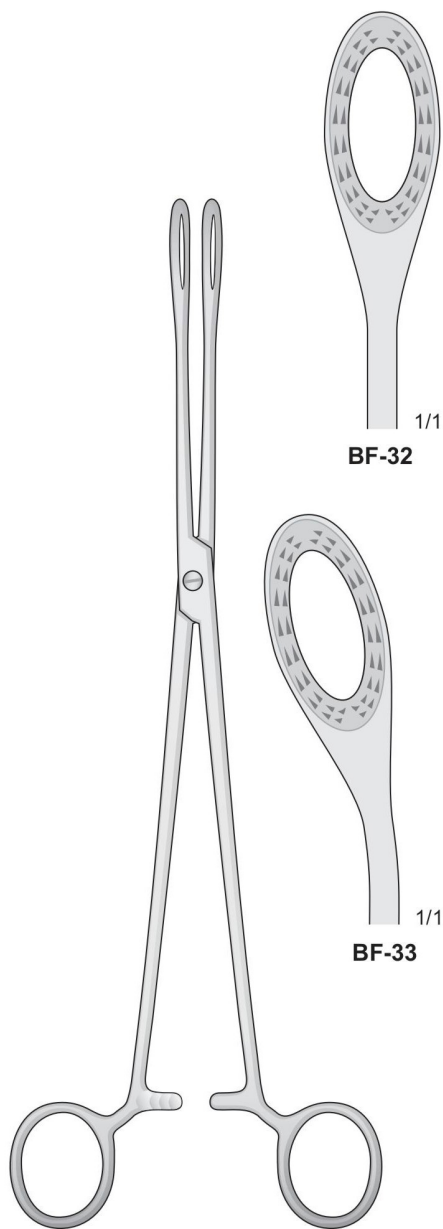

BF-32/BF-33
280 mm

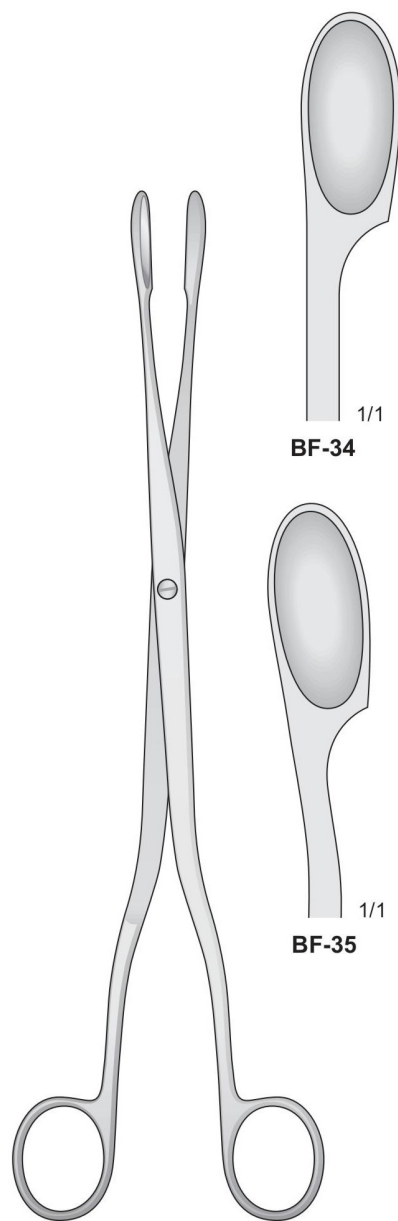

WINTER
BF-34/BF-35
280 mm

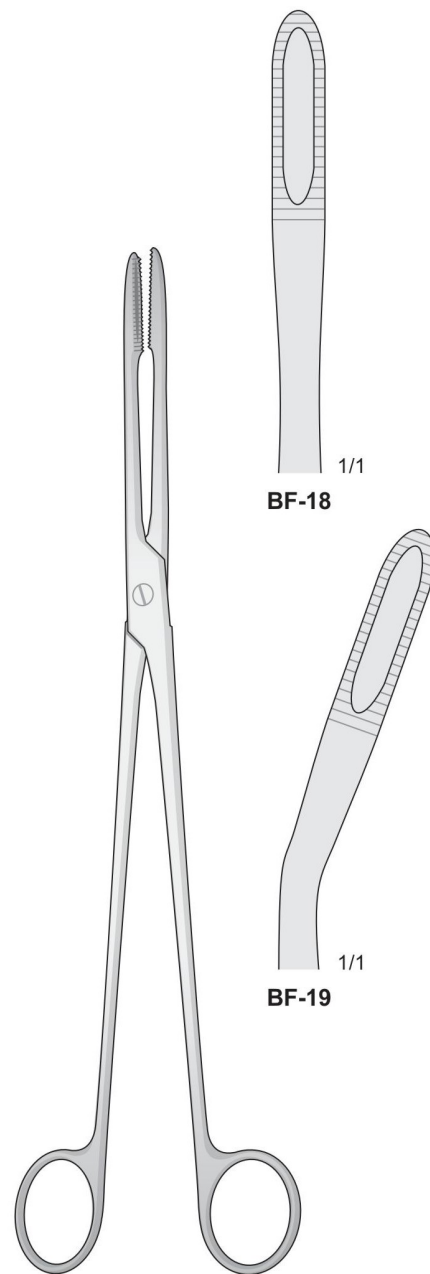

BF-18/BF-19
280 mm

Cotton Swab Forceps / Artery Forceps

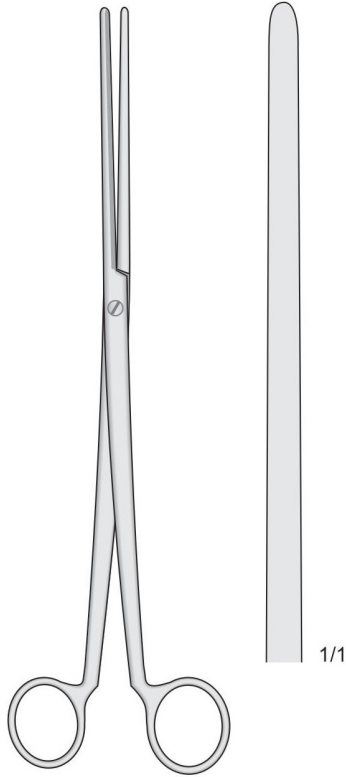

COLLIN
BF-03
260 mm

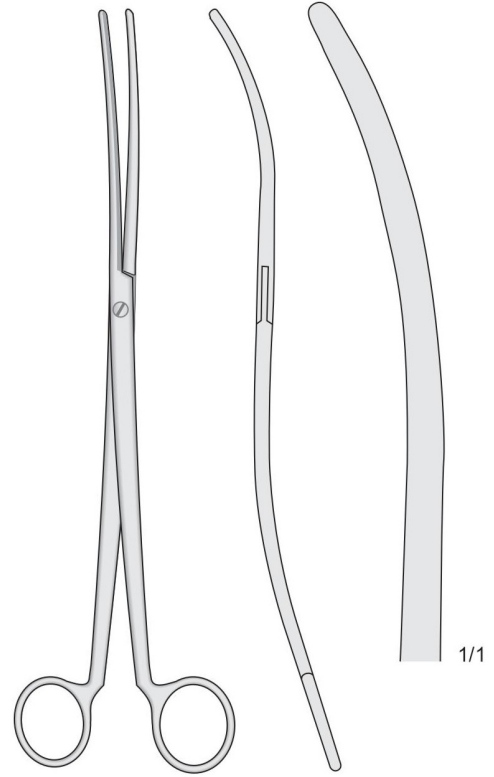

COLLIN
BF-04
260 mm

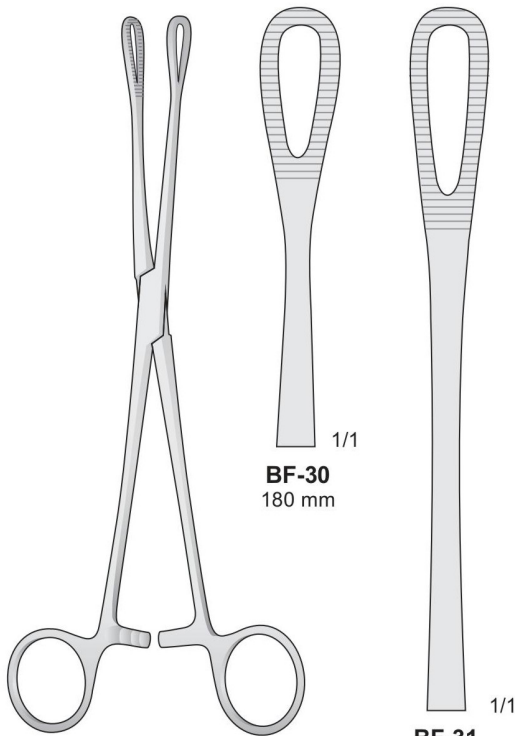

RAMPLEY
BF-30/BF-31

BF-31
245 mm

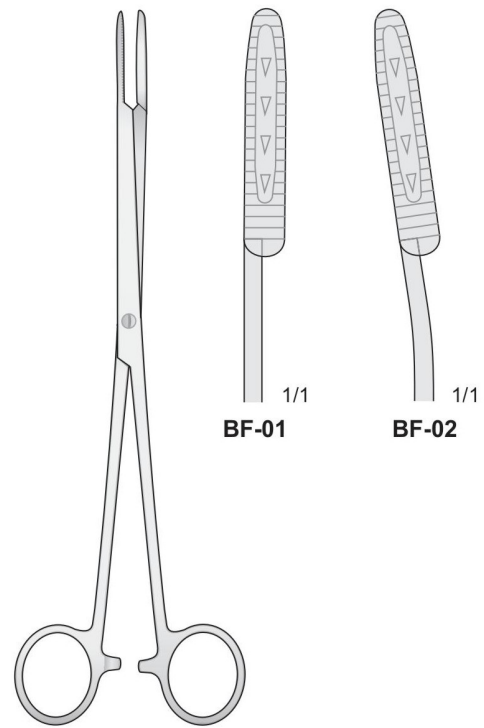

MAIER
BF-01/BF-02
245 mm

Vaginal Specula

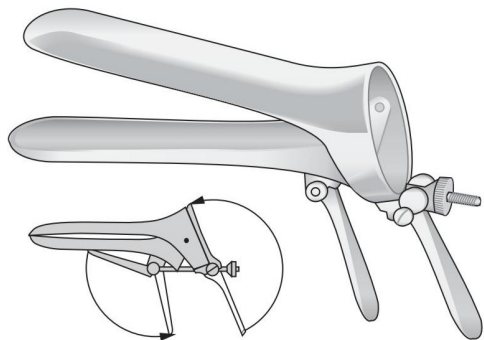

CUSCO
ER-49 Fig. 0 77x17 mm
ER-48 Fig. 1 75x33 mm
ER-47 Fig. 2 86x36 mm
ER-46 Fig. 3 97x36 mm

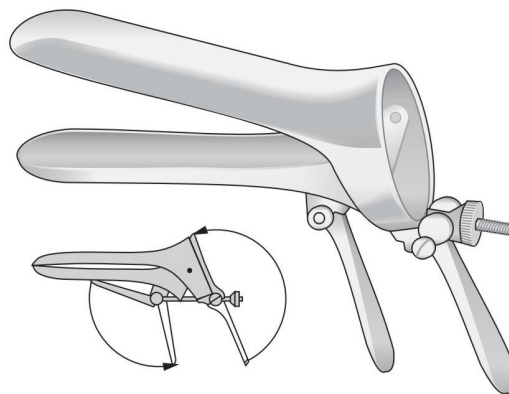

CUSCO
 SCHWEIZER MODELL
ER-61 Fig.1 90x23 mm
ER-62 Fig.2 100x24 mm
ER-63 Fig.3 105x27 mm

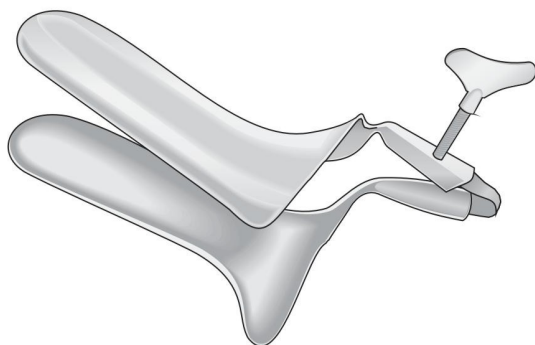

COLLIN-STANDARD
ER-72 Fig. 1 90x29 mm
ER-73 Fig. 2 95x35 mm
ER-74 Fig. 3 110x40 mm



GRAVE
ER-91 75x20 mm
ER-92 95x30 mm
ER-93 105x33 mm

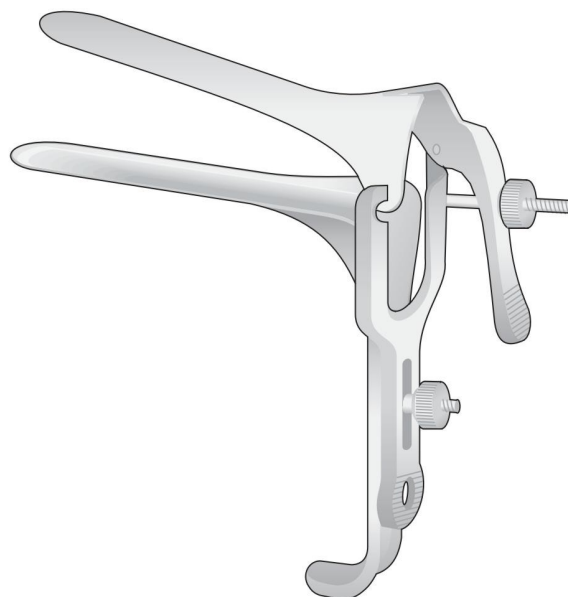

PEDERSON
ER-96 100x22 mm
ER-97 120x25 mm



Vaginal Specula



KALLMORGEN
EB-101 - 70 x 40 mm
 170 mm

EB-102 - 70 x 33 mm
 170 mm

EB-100
 Set 2 pezzi - Set 2 pieces
 Set 2 stück - Set 2 pièces
 Set 2 piezas
 70 x 40 mm
 70 x 33 mm

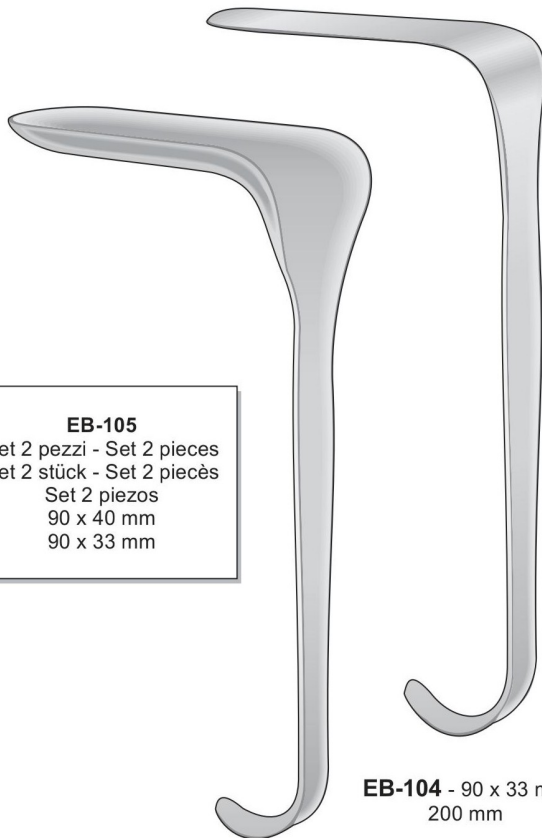

EB-104 - 90 x 33 mm
 200 mm

EB-105
 Set 2 pezzi - Set 2 pieces
 Set 2 stück - Set 2 pièces
 Set 2 piezas
 90 x 40 mm
 90 x 33 mm

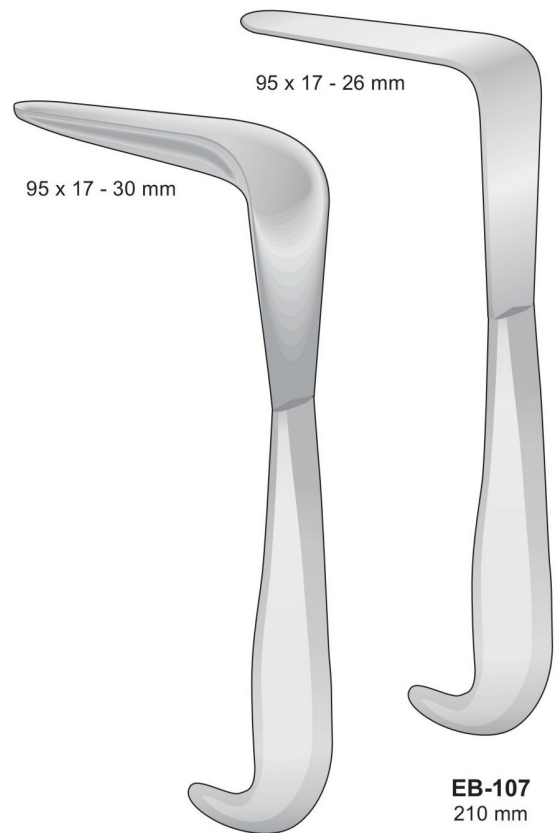

95 x 17 - 30 mm

95 x 17 - 26 mm

KALLMORGEN
EB-103 - 90 x 40 mm
 200 mm

MATHIEU
EB-106
 210 mm

EB-107
 210 mm

Vaginal Specula

Speculum
Spekula
Specula
Spéculums
Espéculos



KRISTELLER
Fig. 1 **EB-120** - 70 x 27 mm
Fig. 2 **EB-121** - 75 x 30 mm
Fig. 3 **EB-122** - 90 x 36 mm

Valva
Halter
Retractors
Valves
Valvas



KRISTELLER
Fig. 1 **EB-123** - 75 x 23 mm
Fig. 2 **EB-124** - 80 x 26 mm
Fig. 3 **EB-125** - 95 x 32 mm

Speculum + Valva
Specula + Retractor
Spekula + Halter
Spéculum + Valve
Espéculo + Valva



Fig. 1 **EB-126**
Fig. 2 **EB-127**
Fig. 3 **EB-128**

Speculum
Spekula
Specula
Spéculums
Espéculos



KRISTELLER
Fig. 00 **EB-130** - 110 x 18 mm
Fig. 0 **EB-131** - 110 x 21 mm
Fig. 1 **EB-132** - 110 x 27 mm
Fig. 2 **EB-133** - 110 x 30 mm
Fig. 3 **EB-134** - 110 x 36 mm

Valva
Halter
Retractors
Valves
Valvas



KRISTELLER
Fig. 00 **EB-135** - 115 x 14 mm
Fig. 0 **EB-136** - 115 x 17 mm
Fig. 1 **EB-137** - 115 x 23 mm
Fig. 2 **EB-138** - 115 x 26 mm
Fig. 3 **EB-139** - 115 x 32 mm

Speculum + Valva
Specula + Retractor
Spekula + Halter
Spéculum + Valve
Espéculo + Valva



Fig. 00 **EB-140**
Fig. 0 **EB-141**
Fig. 1 **EB-142**
Fig. 2 **EB-143**
Fig. 3 **EB-144**



Vaginal Specula



DOYEN
EB-150/EB-166
240 mm

- Fig. 1 **EB-150** - 60 x 35 mm
- Fig. 2 **EB-151** - 90 x 35 mm
- Fig. 3 **EB-152** - 120 x 35 mm

- Fig. 1 **EB-156** - 60 x 45 mm
- Fig. 2 **EB-157** - 90 x 45 mm
- Fig. 3 **EB-158** - 120 x 45 mm
- Fig. 4 **EB-160** - 160 x 45 mm

- Fig. 1 **EB-162** - 60 x 60 mm
- Fig. 2 **EB-163** - 90 x 60 mm
- Fig. 3 **EB-164** - 120 x 60 mm
- Fig. 4 **EB-166** - 160 x 60 mm

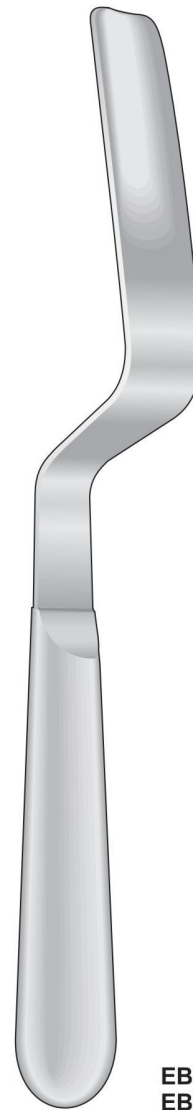

LANDAU
EB-190/EB-191
290 mm

- EB-190** - 100 x 28 mm
- EB-191** - 100 x 38 mm



Vaginal Specula



BREISKY
EB-170 - 100 x 20 mm
EB-171 - 100 x 25 mm
EB-172 - 100 x 30 mm
EB-173 - 100 x 35 mm
EB-174 - 100 x 40 mm
 290 mm

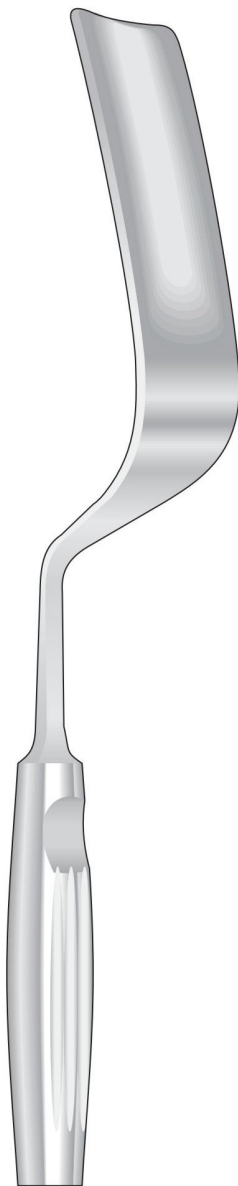

BREISKY
EB-175 - 130 x 20 mm
EB-176 - 130 x 25 mm
EB-177 - 130 x 30 mm
EB-178 - 130 x 35 mm
EB-179 - 130 x 40 mm
 320 mm

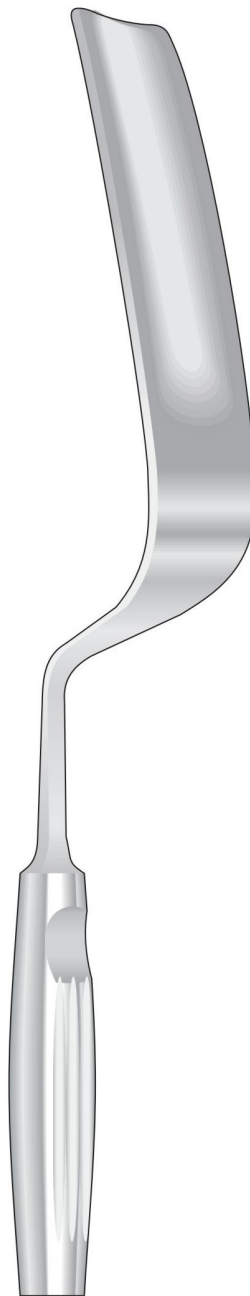

BREISKY
EB-184 - 160 x 40 mm
 350 mm

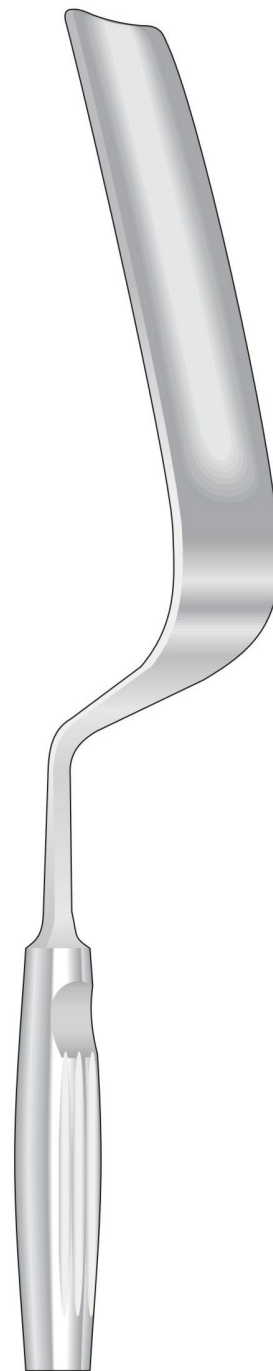

BREISKY
EB-189 - 180 x 40 mm
 370 mm



Uterine Dilatators

Hegar Dilatatori - Hegar Dilatators - Hegar Dilatatore - Hegar Dilateur - Hegar Dilatadores



Ø 2 mm	Ø 4 mm	Ø 6 mm	Ø 8 mm	Ø 10 mm	Ø 12 mm	Ø 14 mm
Ø 1 mm	Ø 3 mm	Ø 5 mm	Ø 7 mm	Ø 9 mm	Ø 11 mm	Ø 13 mm
ER-120 200 mm	ER-121 200 mm	ER-122 200 mm	ER-123 200 mm	ER-124 200 mm	ER-125 200 mm	ER-126 200 mm
Ø 16 mm	Ø 18 mm	Ø 20 mm	Ø 22 mm	Ø 24 mm	Ø 26 mm	
Ø 15 mm	Ø 17 mm	Ø 19 mm	Ø 21 mm	Ø 23 mm	Ø 25 mm	
ER-127 200 mm	ER-128 200 mm	ER-129 200 mm	ER-130 200 mm	ER-131 200 mm	ER-132 200 mm	

Uterine Dilatators

Pratt Dilatori - Pratt Dilators - Pratt Dilatoren
Pratt Dilateur - Pratt Diladores

ER-110
Set completo dilatatori 8 pezzi
Set complete with 8 pieces
Satz-Dilatator, komplett, 8 stück
Jeu complet avec 8 pieces
Juego completo con 8 piezas

Fig.	mm
13/15	4,5/5,0
17/19	5,6/6,3
21/23	7,0/7,6
25/27	8,3/9,0
29/31	9,6/10,3
33/35	11,0/11,6
37/39	12,3/13,0
41/43	13,6/14,3

La misura è in French
Breite in French

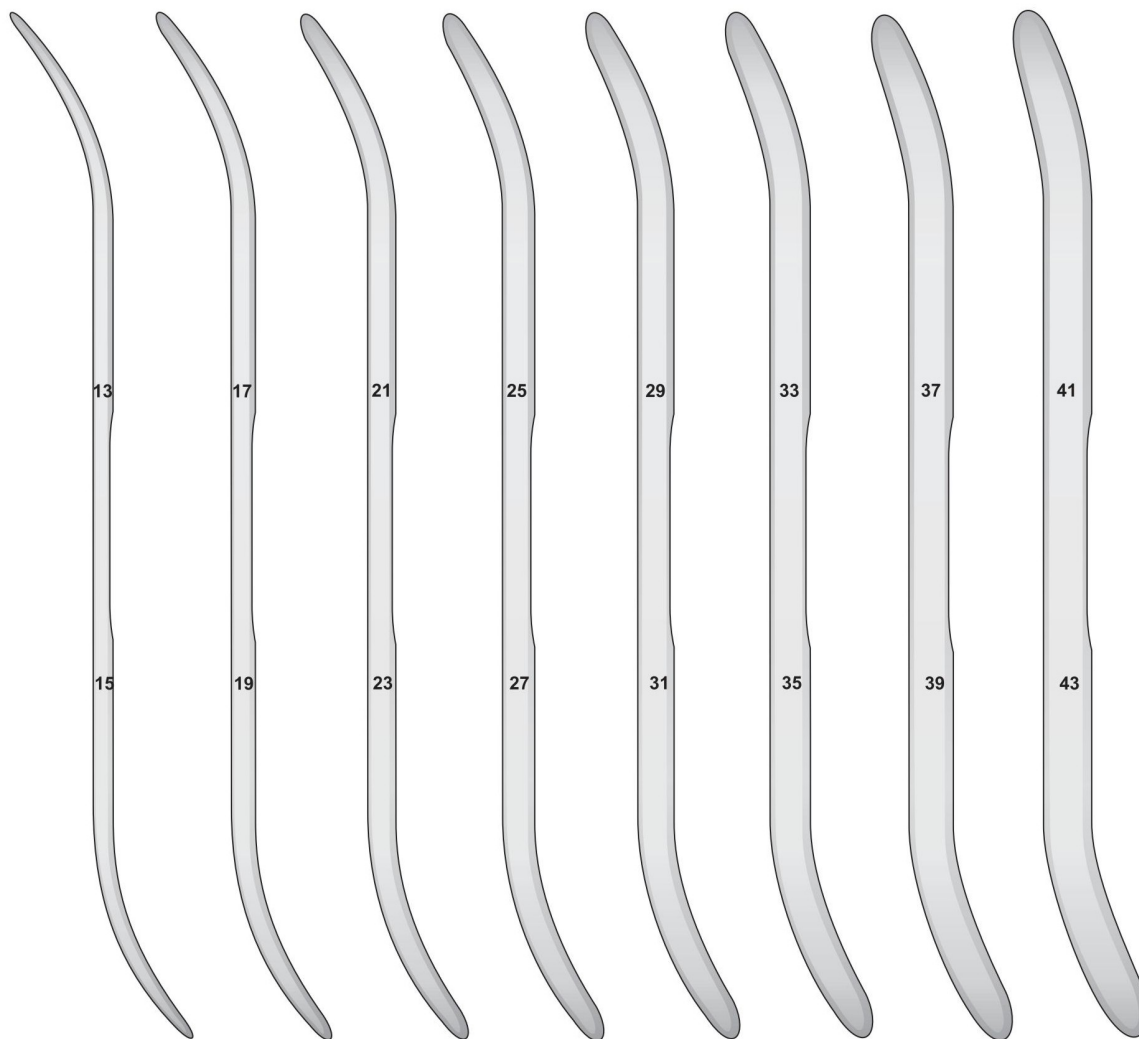

ER-111 260 mm **ER-112** 260 mm **ER-113** 260 mm **ER-114** 260 mm **ER-115** 260 mm **ER-116** 260 mm **ER-117** 260 mm **ER-118** 260 mm



Uterine Dilatators



HEGAR
EB-51/EB-93
185 mm

EB-51	1 mm	EB-64	14 mm	EB-77	1½ mm	EB-90	14½ mm
EB-52	2 mm	EB-65	15 mm	EB-78	2½ mm	EB-91	15½ mm
EB-53	3 mm	EB-66	16 mm	EB-79	3½ mm	EB-92	16½ mm
EB-54	4 mm	EB-67	17 mm	EB-80	4½ mm	EB-93	17½ mm
EB-55	5 mm	EB-68	18 mm	EB-81	5½ mm		
EB-56	6 mm	EB-69	19 mm	EB-82	6½ mm		
EB-57	7 mm	EB-70	20 mm	EB-83	7½ mm		
EB-58	8 mm	EB-71	21 mm	EB-84	8½ mm		
EB-59	9 mm	EB-72	22 mm	EB-85	9½ mm		
EB-60	10 mm	EB-73	23 mm	EB-86	10½ mm		
EB-61	11 mm	EB-74	24 mm	EB-87	11½ mm		
EB-62	12 mm	EB-75	25 mm	EB-88	12½ mm		
EB-63	13 mm	EB-76	26 mm	EB-89	13½ mm		

Fig. 9/10
Ø 4,5/5,0 mm

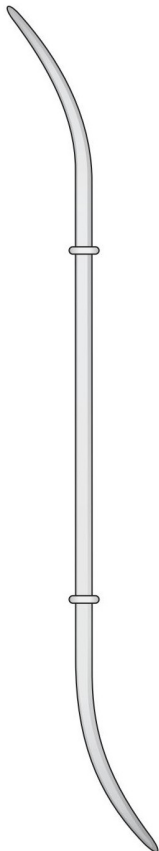

HANK
ER-161
260 mm

Fig. 11/12
Ø 5,5/6,0 mm

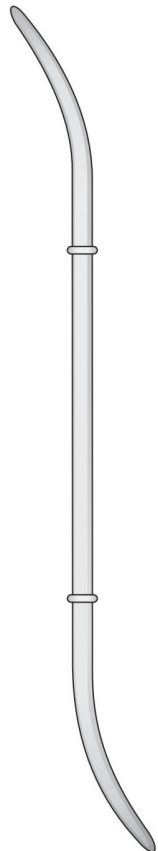

HANK
ER-162
260 mm

Fig. 13/14
Ø 6,5/7,0 mm

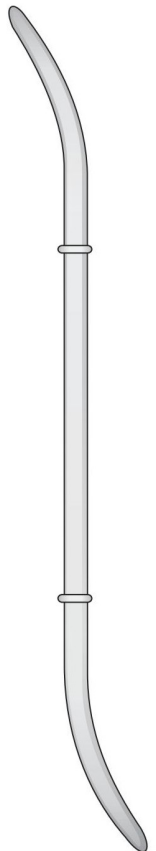

HANK
ER-163
260 mm

Fig. 15/16
Ø 7,5/8,0 mm

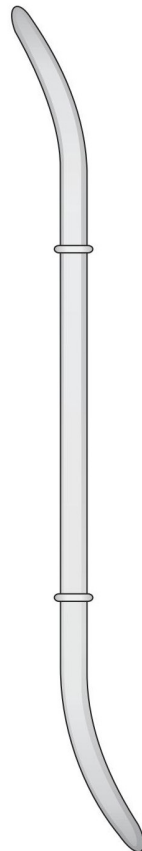

HANK
ER-164
260 mm

Fig. 17/18
Ø 8,5/9,0 mm

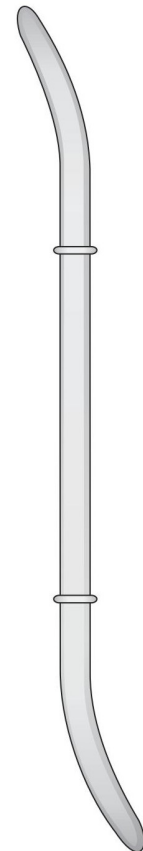

HANK
ER-165
260 mm

Fig. 19/20
Ø 9,5/10 mm

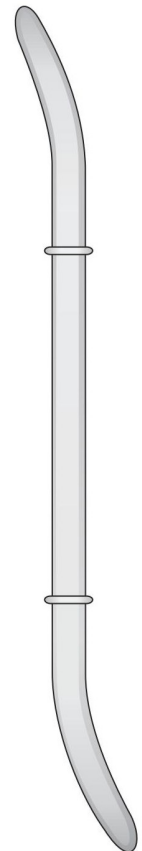

HANK
ER-166
260 mm

Uterine Sounds

Graduati in centimetri
 Graduated in centimeters
 Zentimetereinteilung
 Gradué en centimètres
 Graduado en centímetros

Malleabile
 Malleable
 Biagsam
 Malléables
 Maleables

Malleabile
 Malleable
 Biagsam
 Malléables
 Maleables

Rigido
 Rigid
 Fest
 Rigides
 Rígidos

Malleabile
 Malleable
 Biagsam
 Malléables
 Maleables

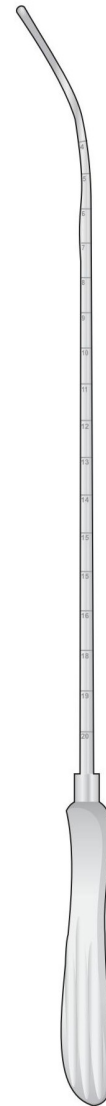
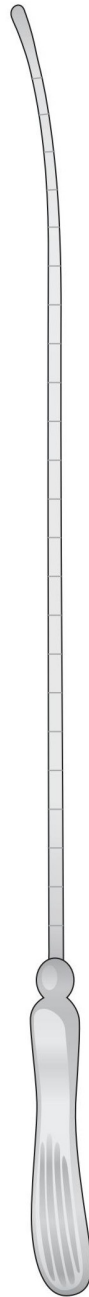
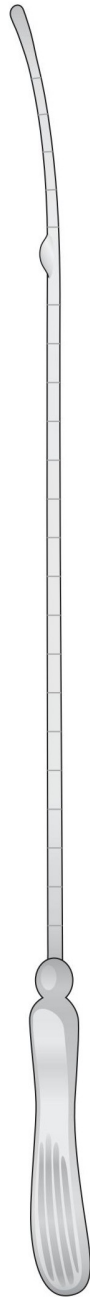
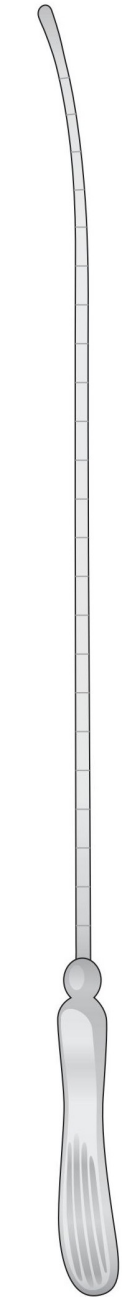

ER-100
 Ø 2 mm
ER-101
 Ø 3 mm
ER-102
 Ø 4 mm

ER-104
 Ø 3 mm
ER-105
 Ø 4 mm

SIMS
ER-100/ER-102
 320 mm

SIMPSON
ER-103 Ø 3 mm
 320 mm

SIMS
ER-104/ER-105
 320 mm

VALLEIX
ER-107 Ø 4 mm
 265 mm

MARTIN
ER-106 Ø 3 mm
 300 mm

MAYO
ER-108 Ø 5 mm
 330 mm



Uterine Tenaculum Forceps



Amniotomo per la vescica amniotica
 Amniotome for the amnion bladder
 Amniotom für die Amnionblase
 Amniotome pour la vésicule amniotique
 Amniotomo para la vesicula amniotica

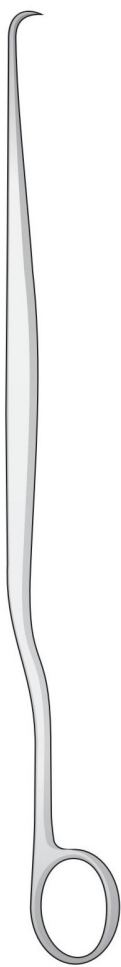

**BEACHAM
BF-55**
260 mm

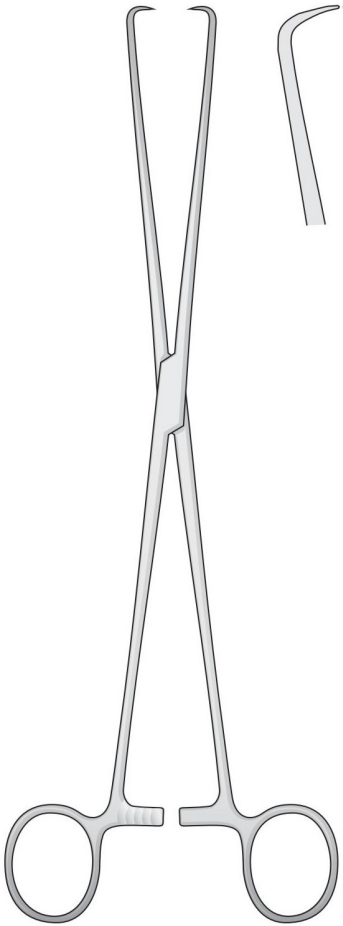

**BRAUN
BF-49**
250 mm

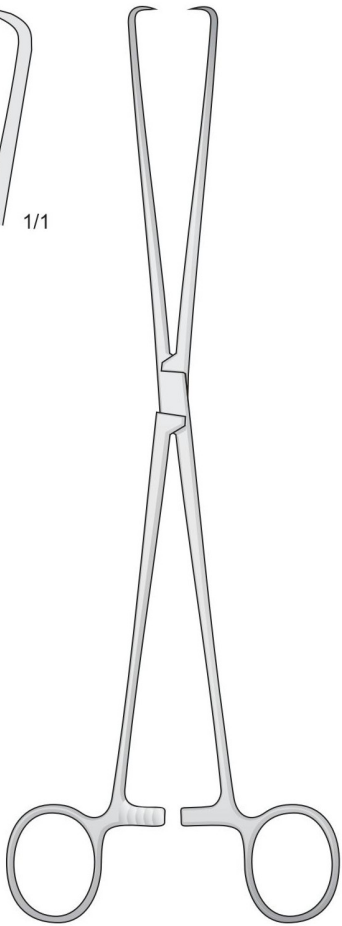
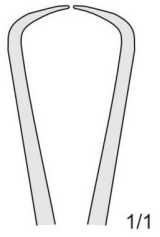

**POZZI
BF-60**
250 mm

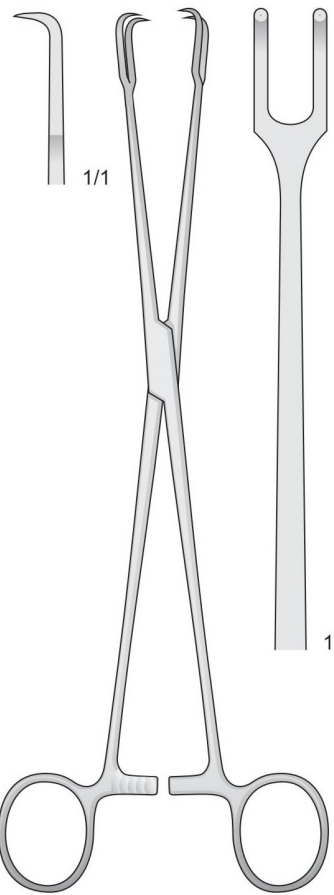

**SCHROEDER
BF-59**
240 mm

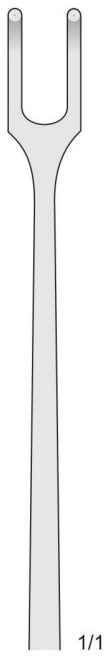
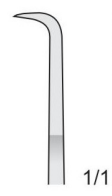

Uterine Tenaculum Forceps

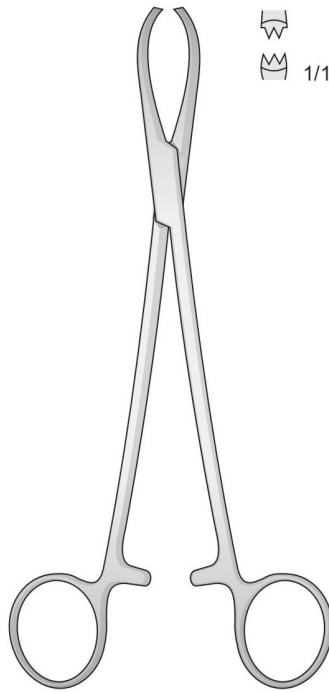

LITTLEWOOD
EB-25
185 mm

Con curvatura laterale
Curved Sideway
Seitwärts Gebogen
Courbes sur le côté
Curvas laterales

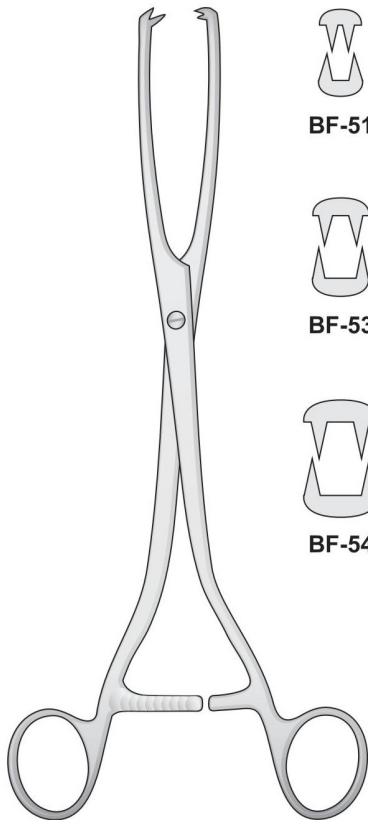

BF-51



BF-53



BF-54

MUSEUX
BF-51/BF-54
240 mm

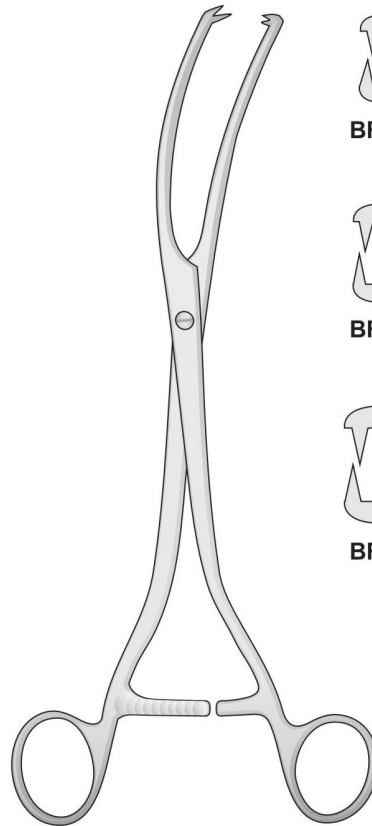

BF-61



BF-62



BF-63

MUSEUX
BF-61/BF-63
240 mm



Myoma Instruments for Micro Tubal Operation



NEUBÜSER
ER-150/ER-152
200 mm

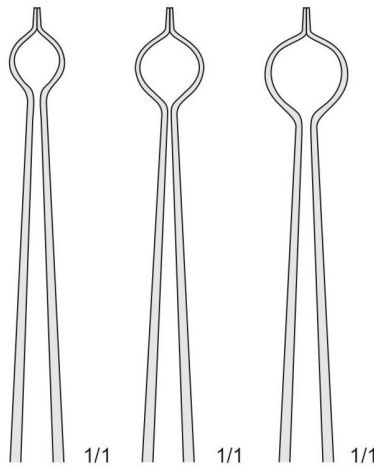

ER-150 Ø 6 mm
ER-151 Ø 8 mm
ER-152 Ø 10 mm

Pinzette per la presa delle tube
Tubal seizing forceps
Tubenfasspinzetten
Pincés pour saisir les tubes

Elevatori per miomi
Myoma screw
Myomheber
Tracteur pour fibromes
Tiramiomas para fibromas



DOYEN
EB-15
150 mm

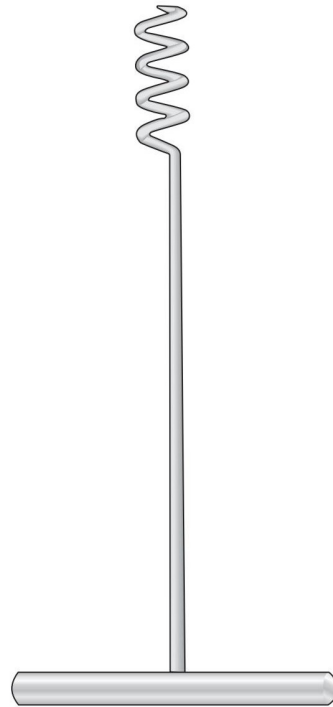

DOYEN
EB-16
170 mm

Uterine Biopsy Aspirating Curettes



Curette per biopsia endouterina
 Endometrial Biopsy curette
 Endometrium-Strichkurette
 Curette pour biopsie intra-utérines
 Cureta para biopsia endo-uterina

Curette per biopsia endocervicale
 Endocervical Biopsy Curettes
 Endocervix-Biopsieküretten
 Curettes pour biopsies
 endo-cervicales

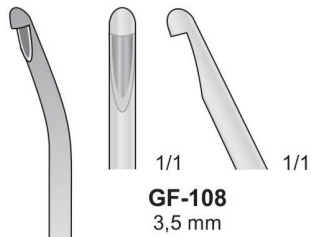

GF-108
3,5 mm

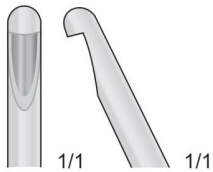

GF-109
5 mm

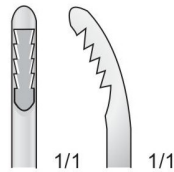

GF-135
Ø 1 mm
GF-136
Ø 2 mm
GF-137
Ø 3 mm
GF-138
Ø 4 mm

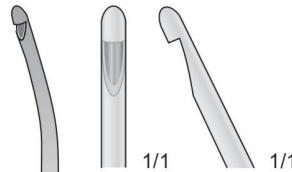

RANDALL
GF-139
230 mm

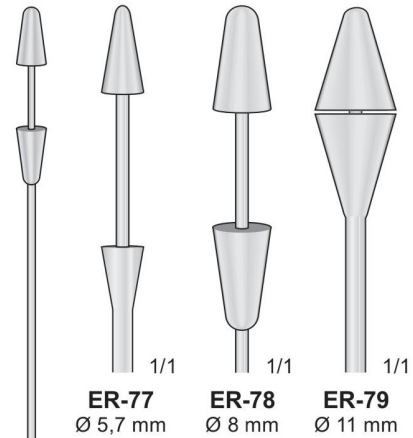

ER-77
Ø 5,7 mm **ER-78**
Ø 8 mm **ER-79**
Ø 11 mm

MÜNCHEN
GF-108/GF-109
270 mm

NOVAK
GF-135/GF-138
230 mm

GUSBERG
ER-77/ER-79
240 mm

Biopsy Forceps

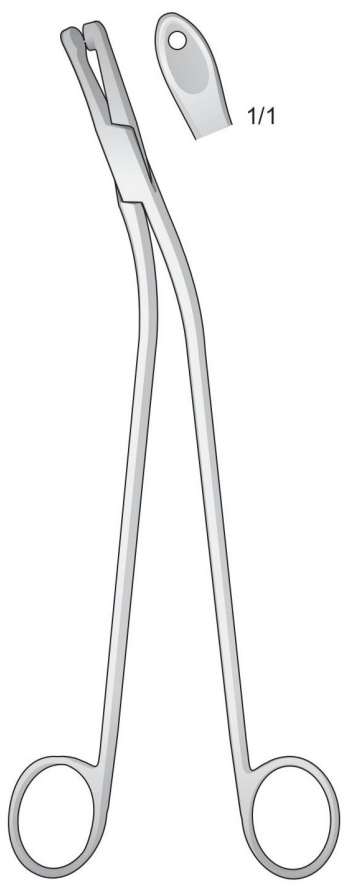

GELLHORN
FF-30
230 mm

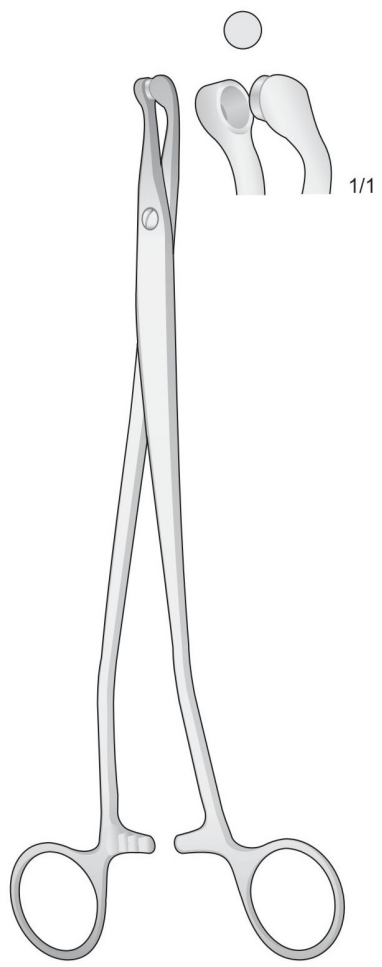

THOMS-GAYLOR
FF-32
240 mm

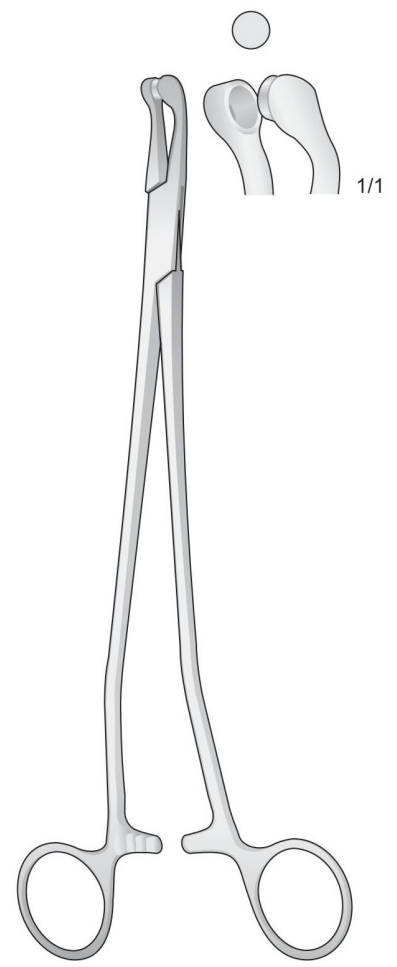

THOMS-GAYLOR
FF-33 220 mm
FF-34 240 mm

Biopsy Forceps

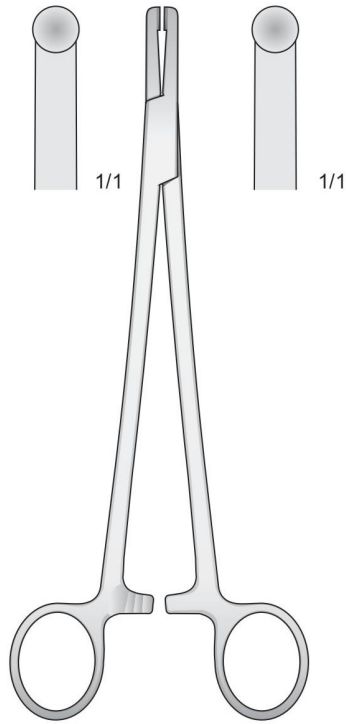

DB-150
205 mm

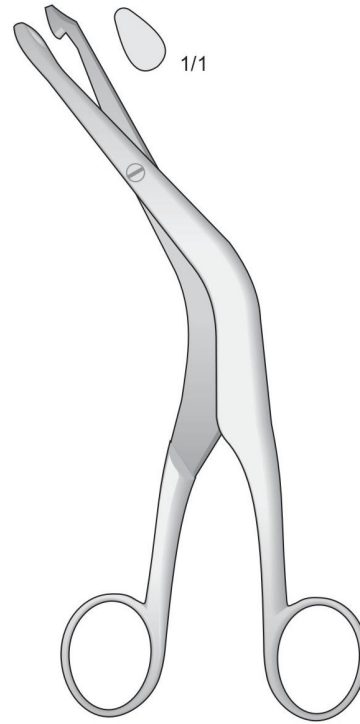

FAURE
FF-31
210 mm

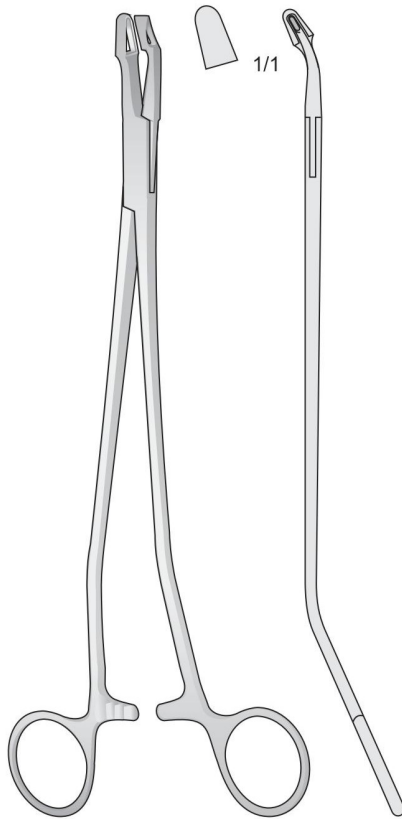

VAN DOREN
FF-39
250 mm

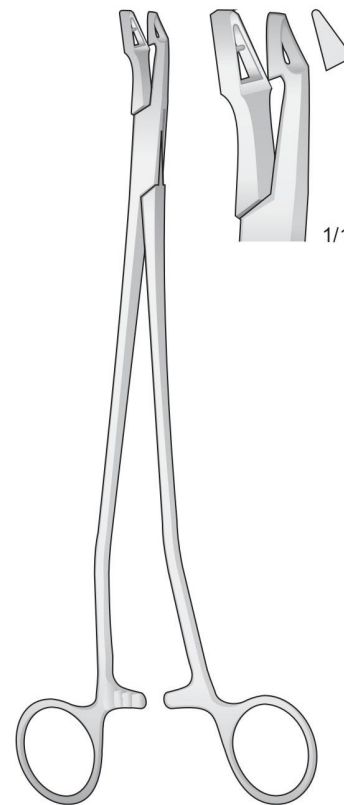

VAN DOREN
FF-38
240 mm



Biopsy Forceps

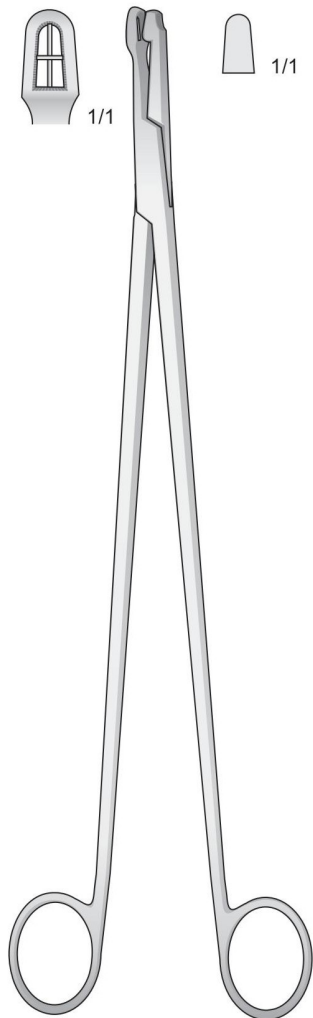
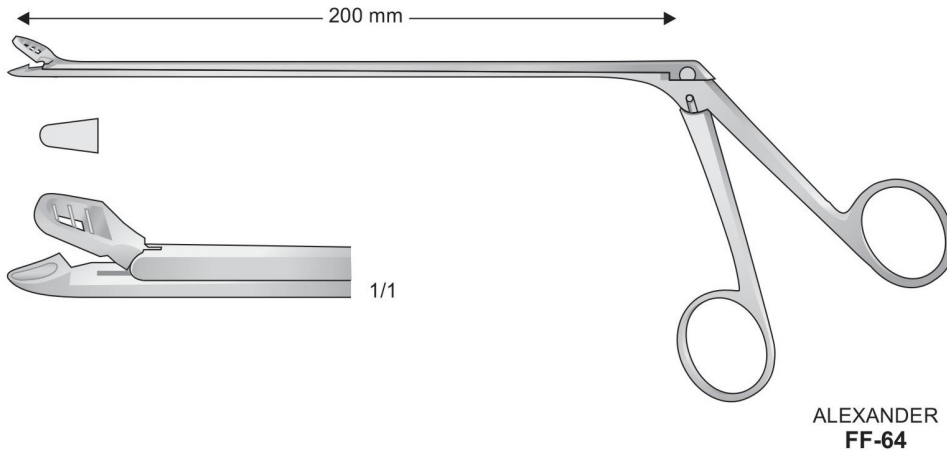

SCHUBERT
FF-35 210 mm
FF-36 290 mm

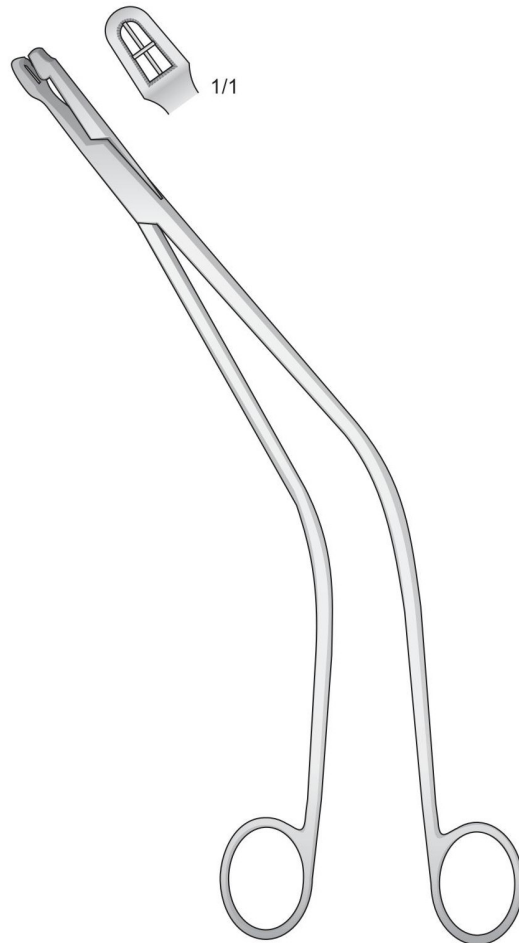

SCHUBERT
FF-37
260 mm

Biopsy Forceps

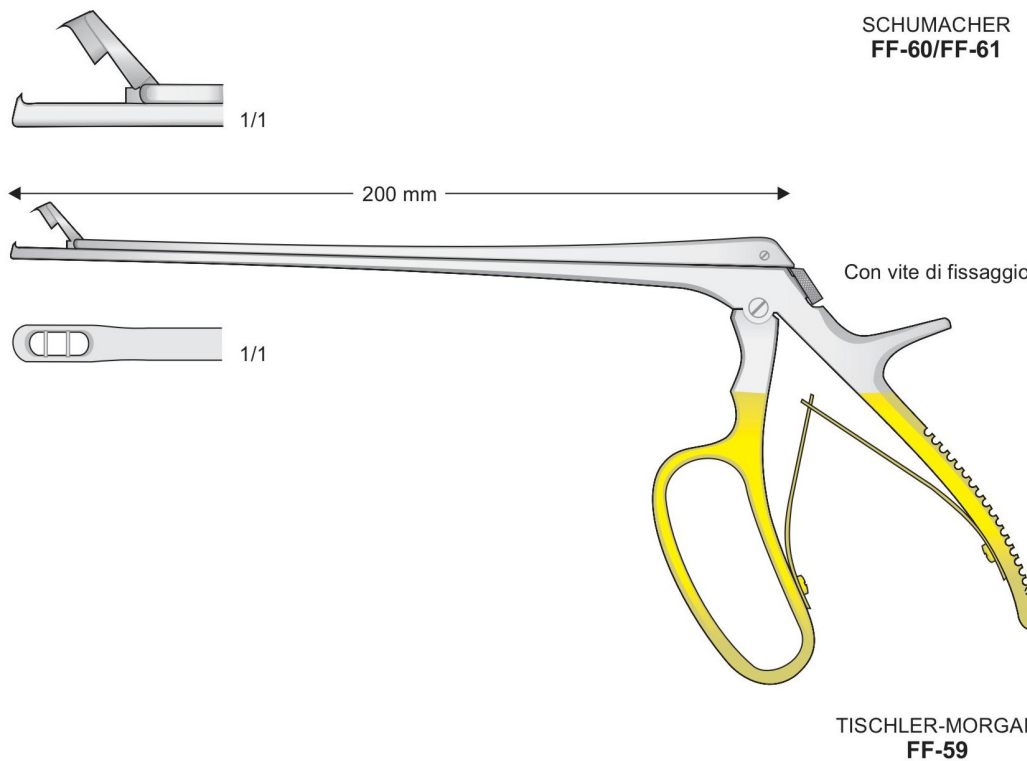
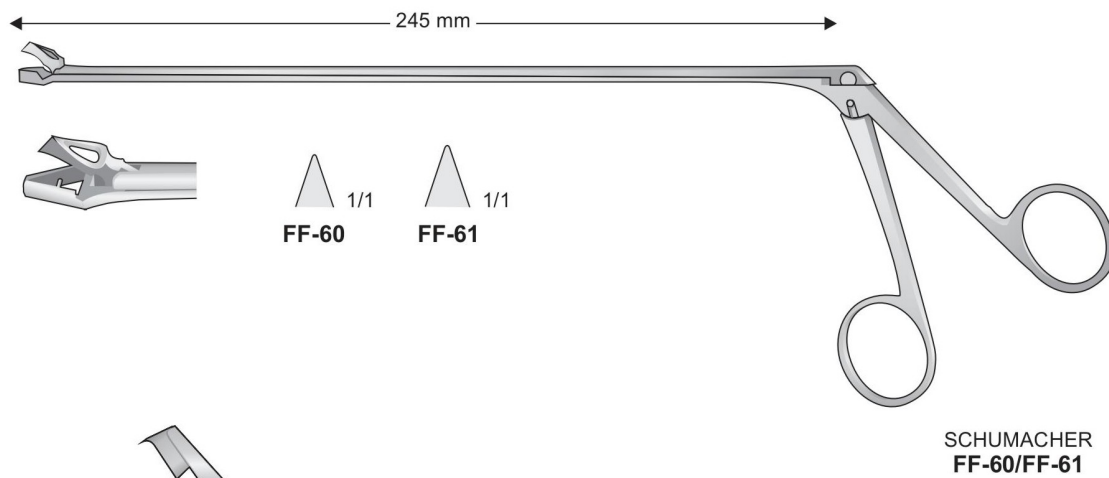
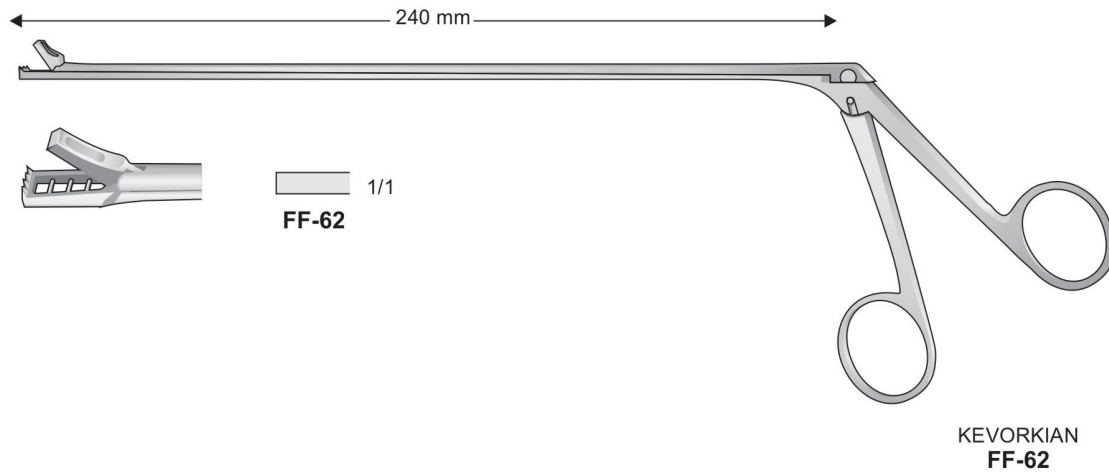

Uterine Curettes



Smusse - Blunt
Stumpf - Mousse
Romo



LUER-KÖRTE
EB-21/EB-23
260 mm

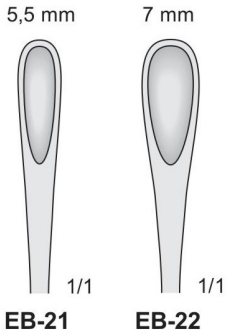

EB-21 1/1 **EB-22** 1/1

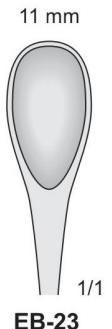

EB-23 1/1

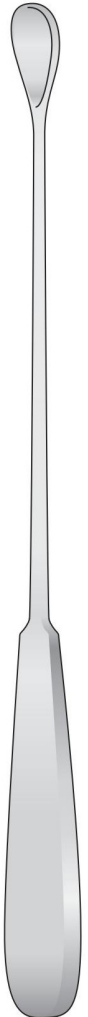

GOURDET
ER-80/ER-84
280 mm

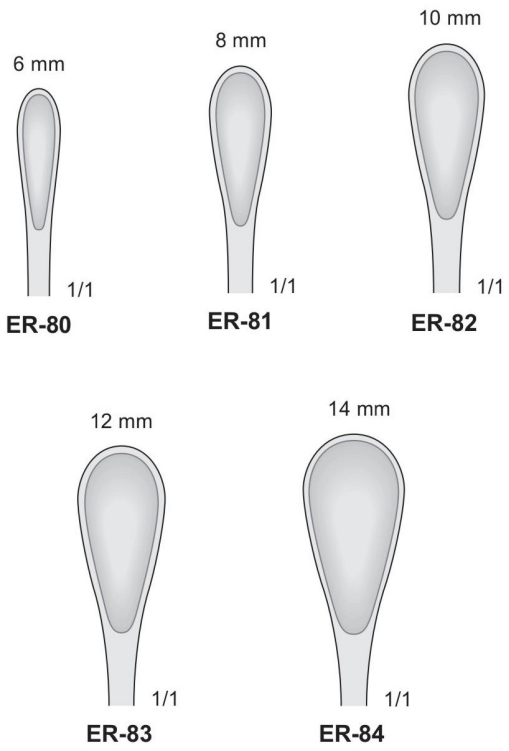

ER-80 1/1 **ER-81** 1/1 **ER-82** 1/1
ER-83 1/1 **ER-84** 1/1

Uterine Curettes



WALLICH
ER-90
420 mm

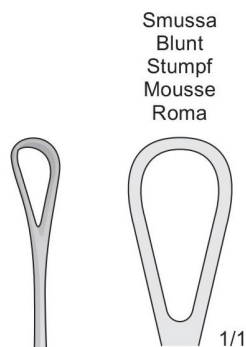

Smussa
Blunt
Stumpf
Mousse
Roma

Tagliente
Sharp
Scharf
Tranchante
Cortante

BLAKE
ER-88
275 mm



Uterine Curettes



Taglienti
Scharp
Scharf
Tranchantes
Cortantes

Smussa
Blunt
Stumpf
Mousse
Romas



RECAMIER
ER-11/ER-28
310 mm

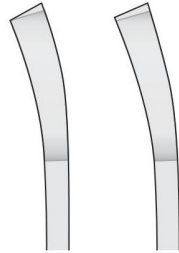

Fig. 1

1/1

Fig. 2

1/1

Fig. 3

1/1

Fig. 4

1/1

Fig. 5

1/1

Fig. 6

1/1

Fig. 7

1/1

Fig. 8

1/1

Fig. Larghezza
Width
Breite

Taglienti-rigide
Sharp-rigid
Scharf-fest
Tranchantes-rigides
Cortantes-rigidas

Smussa-rigide
Blunt-rigid
Stumpf-fest
Mousse-rigides
Romas-rigidas

1	4 mm	ER-11	ER-21
2	6 mm	ER-12	ER-22
3	8 mm	ER-13	ER-23
4	10 mm	ER-14	ER-24
5	12 mm	ER-15	ER-25
6	14 mm	ER-16	ER-26
7	16 mm	ER-17	ER-27
8	18 mm	ER-18	ER-28

Uterine Curettes

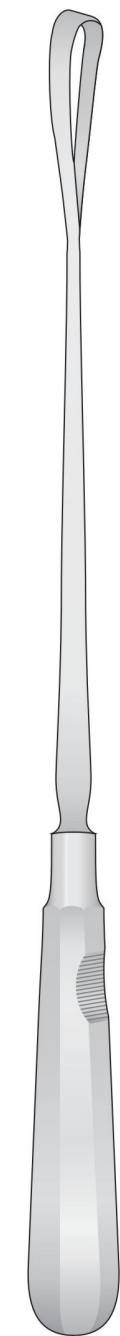

BUMM
ER-31/ER-42
310 mm

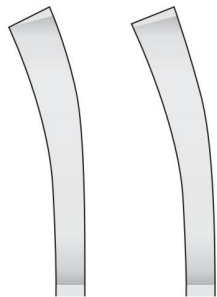

Tagliente
Scharf
Tranchantes
Cortantes

Smussa
Blunt
Stumpf
Mousse
Romas

Malleabile
Malleable
Biegsam
Souples
Maleables

Fig. 3

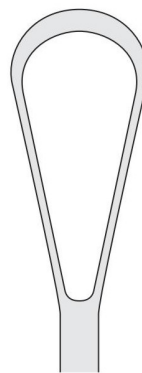

Fig. 4

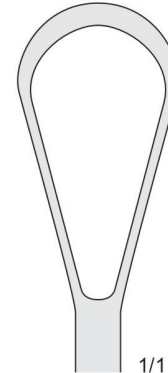

Fig. Larghezza
Width
Breite

Taglienti
Sharp
Sharf
Tranchantes
Cortantes

Smusse
Blunt
Stumpf
Mousse
Romas

Fig.	Larghezza Width Breite	Taglienti Sharp Sharf Tranchantes Cortantes	Smusse Blunt Stumpf Mousse Romas
3	18 mm	ER-31	ER-41
4	20 mm	ER-32	ER-42



Uterine Curettes

Fig.	Larghezza Breite Width	Smusse malleabili - Blunt malleable Stumpf biegsam - Mousse malléables Romas maleables
0	16 mm	ER-140
1	18 mm	ER-141
2	19,5 mm	ER-142
3	21,5 mm	ER-143
4	23,5 mm	ER-144
5	26 mm	ER-145
6	28,5 mm	ER-146

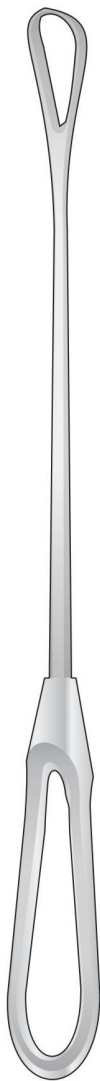

BUMM
ER-140/ER-146
290 mm

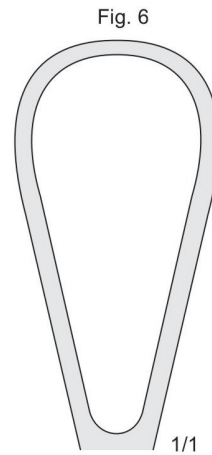
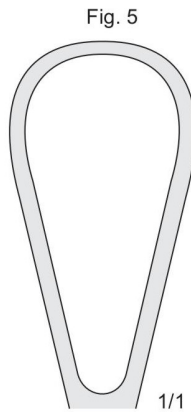
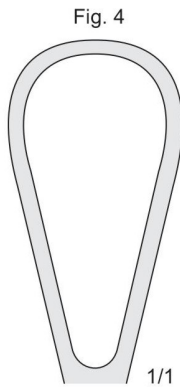
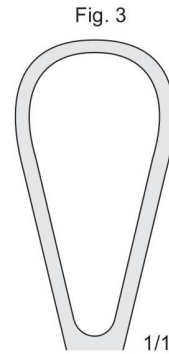
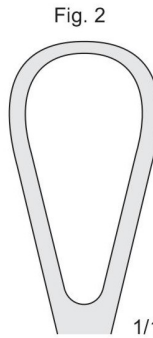
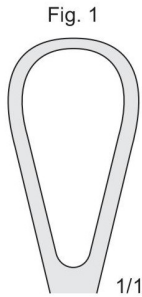

Vaginal Specula and Midwifery Forceps

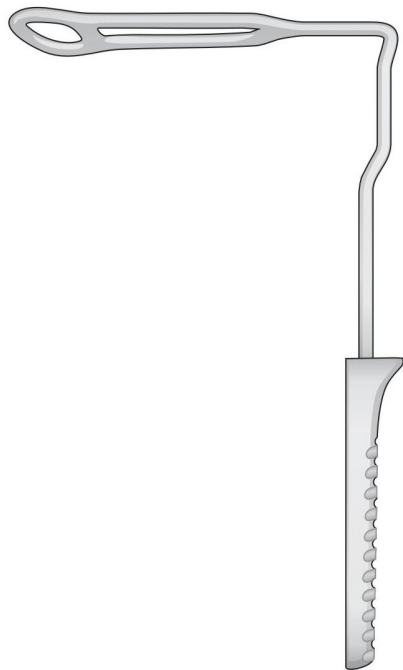

GENTOFT
ER-50
210 mm

Set 2 pezzi
Set 2 pieces
Set 2 Stück
Set 2 pièces
Set 2 piezas
ER-50 + ER-51

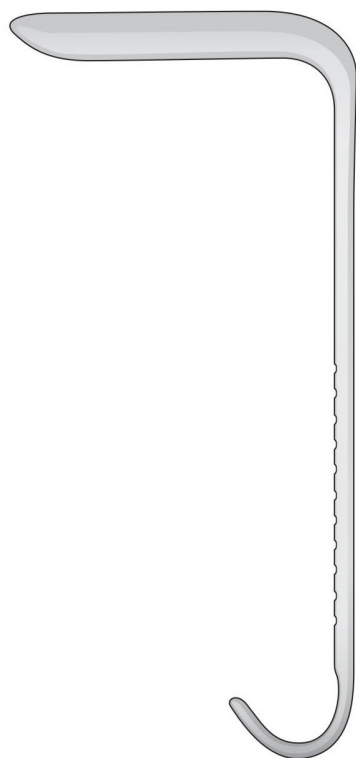

FENO
ER-51
230 mm

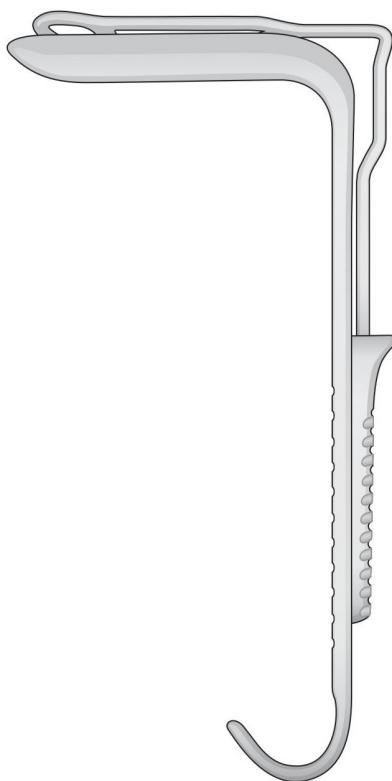

ER-53
230 mm

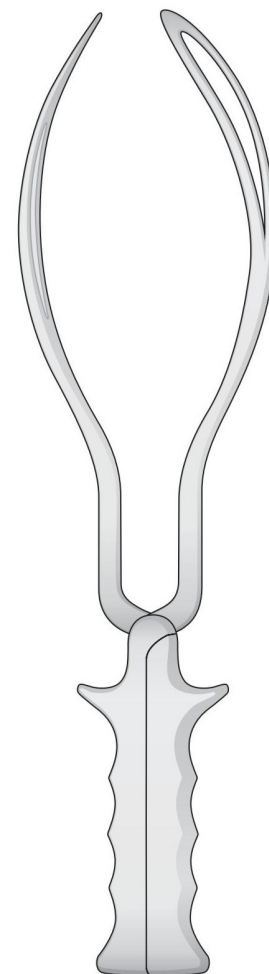

SIMPSON-BRAUN
ER-52
365 mm



Endocervical Specula

Katheter-Einführungsinstrumente
 Catheter introducing instruments
 Strumenti per tendere ed introdurre i cateteri
 Instrumentos para introducir catéteres
 Mandrin pour introduire les sondes

Ø 1,2 mm

Endospekula für Harnröhre und
 Cervix, ohne Sperre
 Endospecula for cervix and urethra,
 without ratchet

Endospekula für Harnröhre und
 Cervix, mit Skalensperre und Fixierschraube
 Endospecula for cervix and urethra,
 with scale-ratchet and fixing screws
 Con cremagliera a scala e vite di fissaggio
 Con cremallera graduada y tornillo de fijación
 Avec crémaillère à échelle et vis à fixation

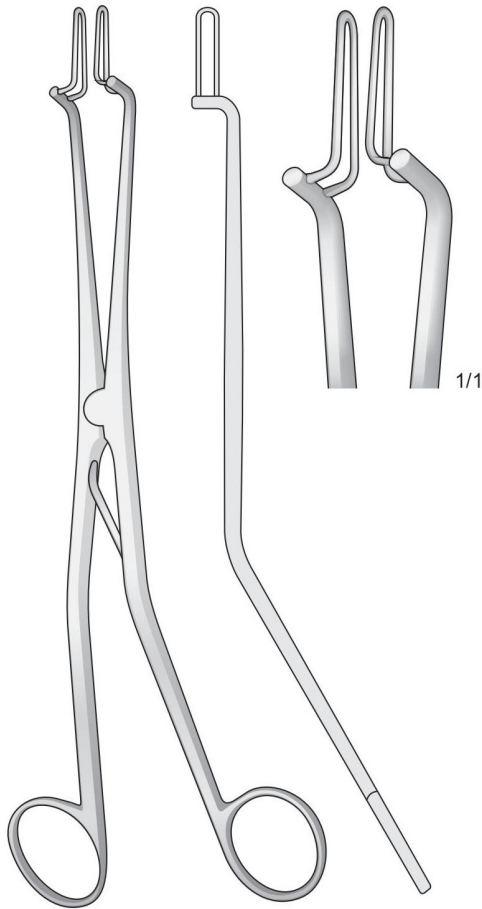

KOGAN
EB-110
 240 mm

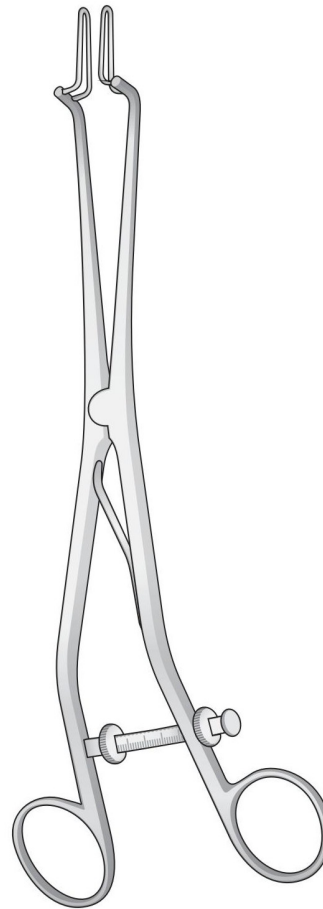

KOGAN
EB-111
 240 mm

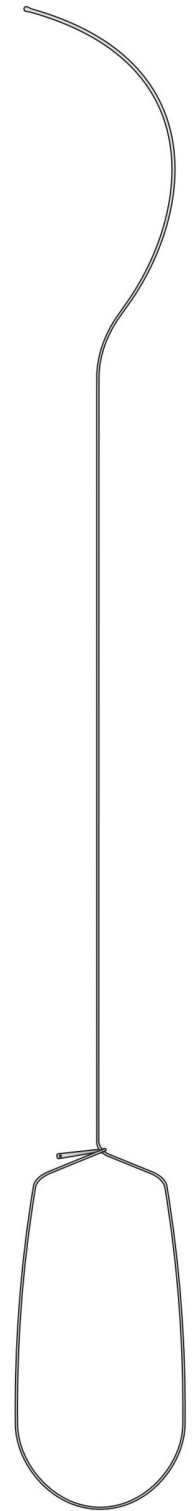

EA-94
 425 mm



Vaginal Specula

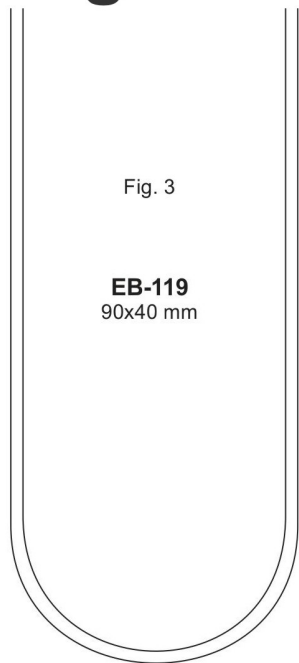

Fig. 3

EB-119
90x40 mm

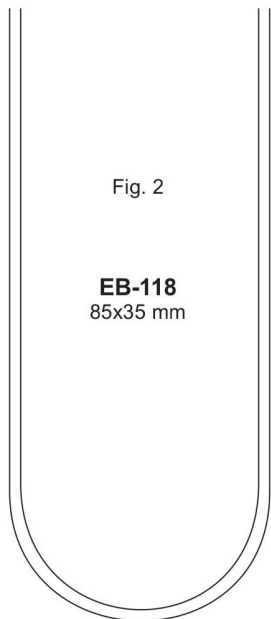

Fig. 2

EB-118
85x35 mm

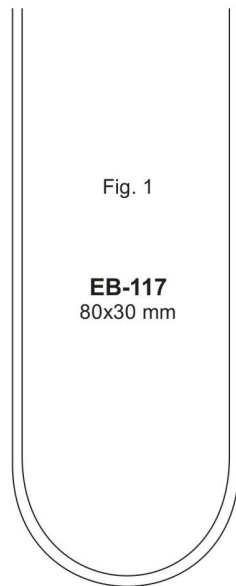
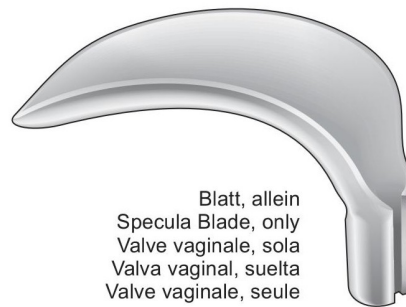

Fig. 1

EB-117
80x30 mm



Blatt, allein
Specula Blade, only
Valve vaginale, sola
Valva vaginal, suelta
Valve vaginale, seule

SCHERBAK
EB-117/EB-119

Blasenhalssperrer
Sounds Bladder
Dilatatore del collo vescicale
Sonda vesicales
Dilatateur pour le col vésical

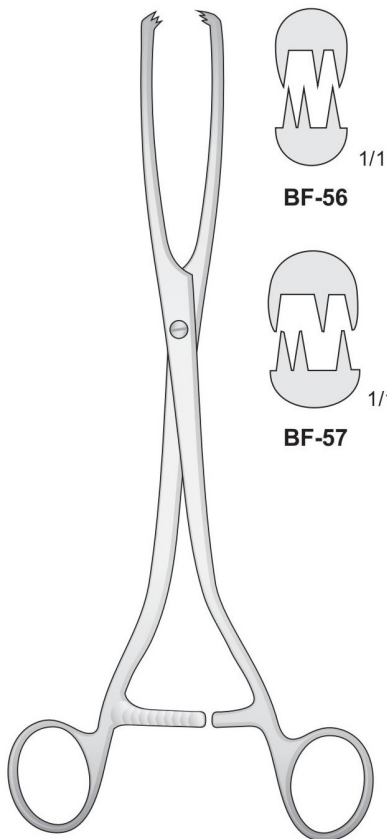

1/1
BF-56

1/1
BF-57

MUSEUX
BF-56/BF-57
265 mm

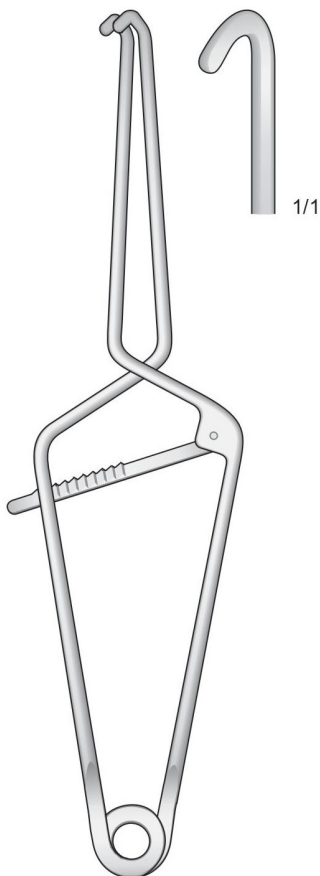

MILLIN
EB-17
280 mm

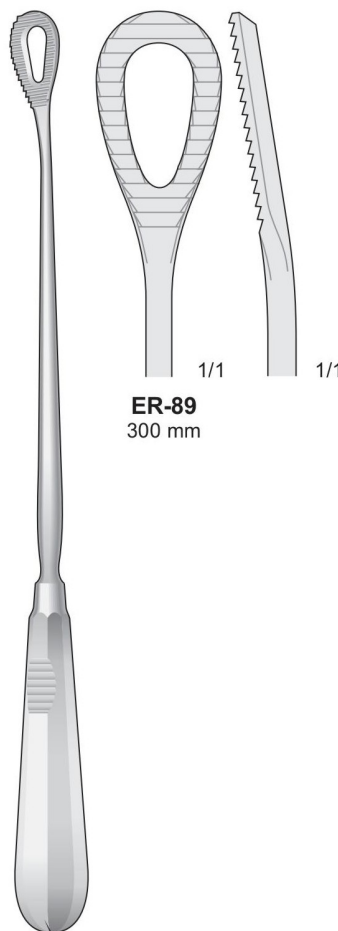

1/1 1/1
ER-89
300 mm

PESTALOZZA
ER-89
300 mm

Biopsiekürette
Uterine Biopsy Curette
Curette per biopsia
Curettes para biopsia
Curettes pour biopsie

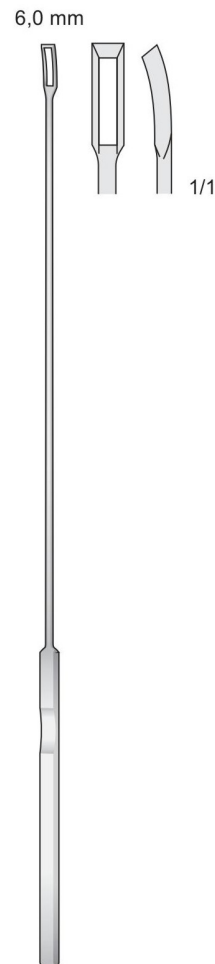

6,0 mm
1/1
KEVORKIAN
ER-87
300 mm



Vaginal Specula

Gewicht zum Vaginalsepekulum
 Weight for Vaginal Speculum
 Peso per specolo vaginale
 Peso para espéculo vaginal
 Poids pour spéculum vaginal



SCHERBAK
EB-294 10,5 mm 400 gr
EB-295 13 mm 800 gr

Blatt, allein
 Specula Blade, only
 Valve vaginale, sola
 Valva vaginal, suelta
 Valve vaginale, seule

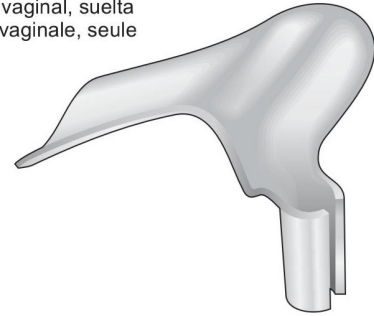

SCHERBAK
EB-291/EB-292

Griff zum Vaginalsepekulum
 Handle for Vaginal Speculum
 Manico per specolo vaginale
 Mango para espéculo vaginal
 Manche pour spéculum vaginal

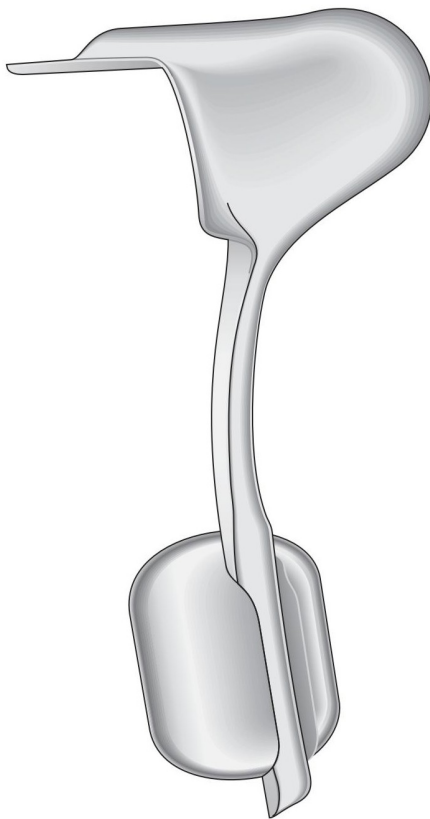

AUVARD
EB-290
 230 mm



SCHERBAK
EB-293
 200 mm

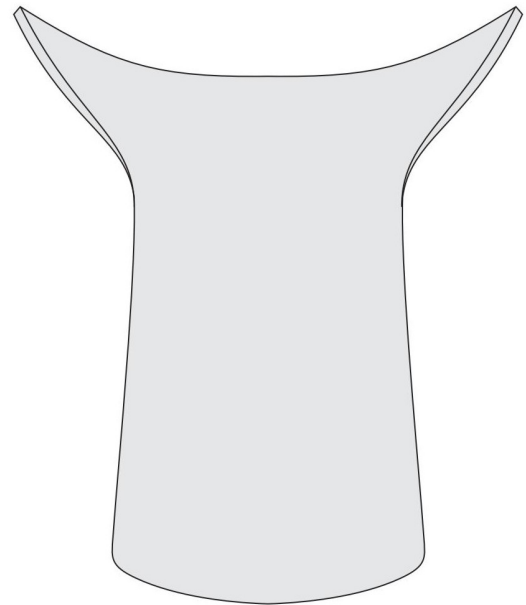

EB-292
 81x45 - 70 mm

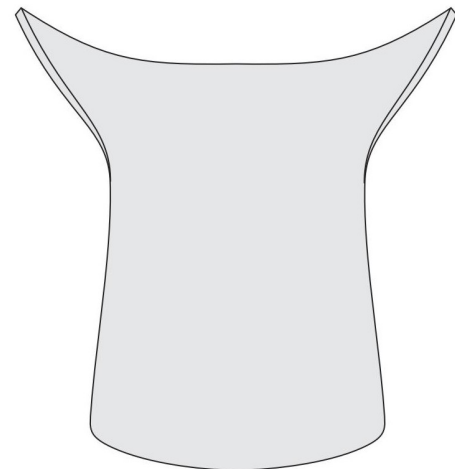

EB-291
 62x40 - 60 mm



Vaginal Specula

Geschwärzt
 Surface Black-finish
 Superficie anti-riflesso
 Surface noireie



ER-58
 75 x 20 mm



ER-59
 100 x 22 mm



ER-60
 120 x 25 mm



Uterine Dilatators



EB-96
Metalletui mit 14 Hegar Uterusdilatoren
Scatola con 14 dilatatori uterini Hegar

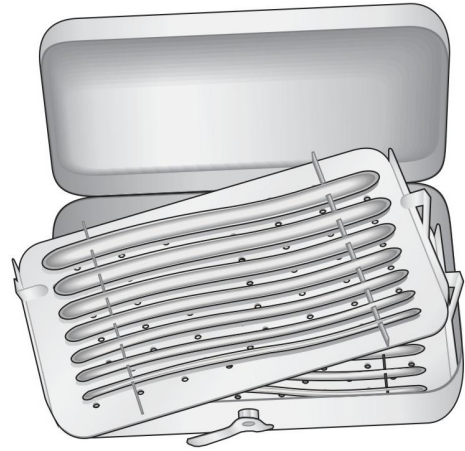

ER-134
Metalletui mit 13 Hegar Uterusdilatoren
Scatola con 13 dilatatori uterini Hegar



ER-133
mit 8 Uterusdilatoren
con 8 dilatatori uterini



ER-135
für 8 Uterusdilatoren
per 8 dilatatori uterini

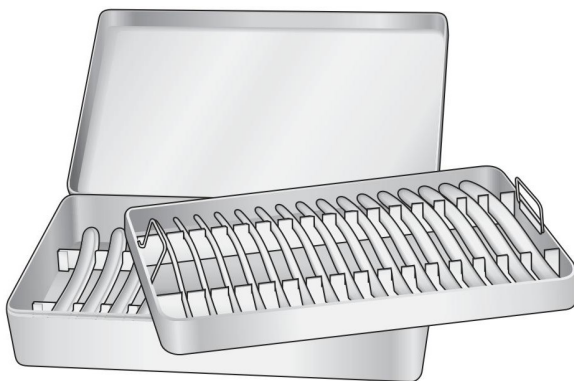

EB-97
Metalletui mit 26 Hegar Uterusdilatoren
Scatola con 26 dilatatori uterini Hegar

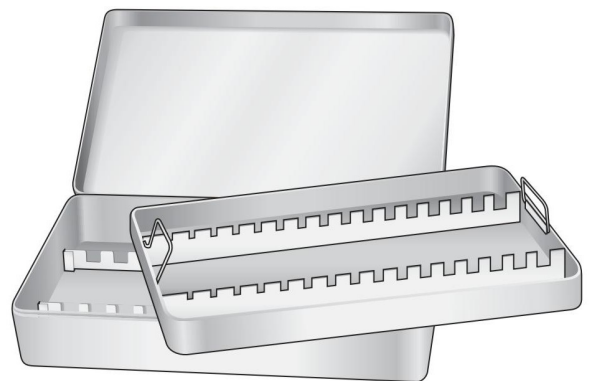

BS-17
Metalletui leer für 26 Hegar Uterusdilatoren
Scatola vuota per 26 dilatatori uterini Hegar



Uterine Depressor

Uterusdepressor
 Uterine Depressor
 Depressore uterino
 Depresor uterino
 Dépresseur utérin



BRAUN
ER-76
 275 mm

Sterilisierzangen zum Fassen und
 Halten Steriler Instrumente
 Sterilizing forceps for picking
 up and holding of sterile instruments
 Pinze per prelevare strumenti sterilizzati
 Pinzas para esterilizaciòn
 Pincas pour instruments stérilisés

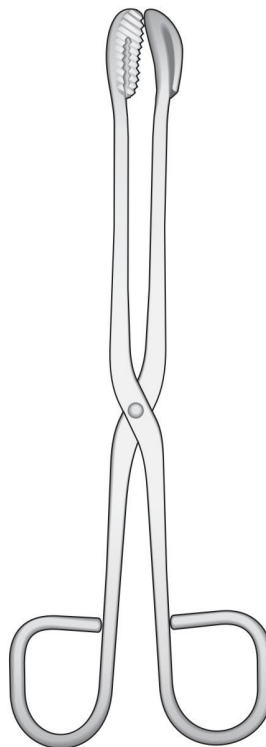

GS-13 200 mm
GS-14 300 mm





Sheffield Surgical Building, Wazirabad Road, Ugoki, Sialkot-51310 Pakistan.
Tell # +92-333-1400682
Email: sheffieldsurgicalinstruments@gmail.com
Email: info@sheffieldsurgicalinst.com
Web: www.sheffieldsurgicalinst.com

