

Surgical Instruments Catalogue
Chirurgische Instrumente Katalog
Instruments chirurgicaux catalogue

Dental Instruments Catalogue



Manufacturer & Exporters of Surgical Instruments



**SHEFFIELD
SURGICAL
INSTRUMENTS**

Quality

Instruments

Since 1992



www.sheffieldsurgicalinst.com





SHEFFIELD SURGICAL BUILDING
Wazirabad Road, Ugoki, Sialkot-51310 Pakistan.

WhatsApp # +92-333-1400682
Email: sheffieldsurgicalinstruments@gmail.com
Email: info@sheffieldsurgicalinst.com
Web: www.sheffieldsurgicalinst.com



Email: sheffieldsurgicalinstruments@gmail.com
Web: www.sheffieldsurgicalinst.com



Table of Contents

Inhaltsverzeichnis
Table des matières
Tabla de contenido
Tavola dei contenuti

004 **Extracting Forceps**

Zahnzangen
Daviers
Pinzas de extracción
Pinze da estrazione

043 **Root Elevators**

Wurzelheber
Elevatori per radici
Elevadores para raíces
Elévateurs pour racines

074 **Scalpel Blades and Handles**

Skalpellschneidmesser und Skalpellschäfte
Lames et manches de bistouri
Hojas y mangos de bisturí
Lame e manici per bisturi

081 **Surgical Scissors**

Chirurgische Scheren
Ciseaux chirurgicaux
Tijeras quirúrgicas
Forbici Chirurgiche

109 **Tissue and Dressing Forceps**

Chirurgische und Anatomische Pinzetten
Pincers à tissu et à pansement
Pinzas quirúrgicas y anatómicas
Pinzette chirurgiche e anatomiche

136 **Needle Holders**

Nadelhalter
Porte-aiguilles
Porta-agujas
Port'aghi

158 **Hemostatic Forcep | Towel Clamps**

Arterienklemmen | Tuchklemmen
Pincers hémostatiques | Fixe-compresses
Pinzas hemostáticas | Pinzas de campo
Pinzette emostatiche | Fissateli

169 **Retractors | Mouth Gags**

Retraktoren | Mundsperrerr
Écarteurs | Ouvre-bouche
Separadores | Abrebocas
Divaricatori | Apribocca

190 **Implantology**

Implantologie
Implantologie
Implantología
Implantologia

213 **Periosteal | Curettes | Rongeurs**

Raspatorien | Küretten |
Hohlmeißelzangen
Rugines | Curettes | Pincers gouges
Periostótomos | Curetas | Pinzas Jias
Scollaperiosteo | Curettes | Pinze ossivore

238 **Dental Restoration | Periodontology**

Restaurative Zahnheilkunde |
Parodontologie
Odontologie conservatrice | Periodontolo
Odontología conservadora | Periodoncia
Odontoiatria conservativa | Parodontologia

303 **Suction Tubes**

Saugkanülen
Canules d'aspiration
Cánulas de aspiracin
Cannule per aspirazione

310 **Orthodontics**

Kieferorthopädie
Orthodontie
Ortodoncia
Ortodonzia

320 **Crown Instruments | Laboratory**

Kroneninstrumente | Labor
Instruments à couronnes | laboratoire
Instrumentos para coronas | laboratorio
Strumenti per corone | laboratorio

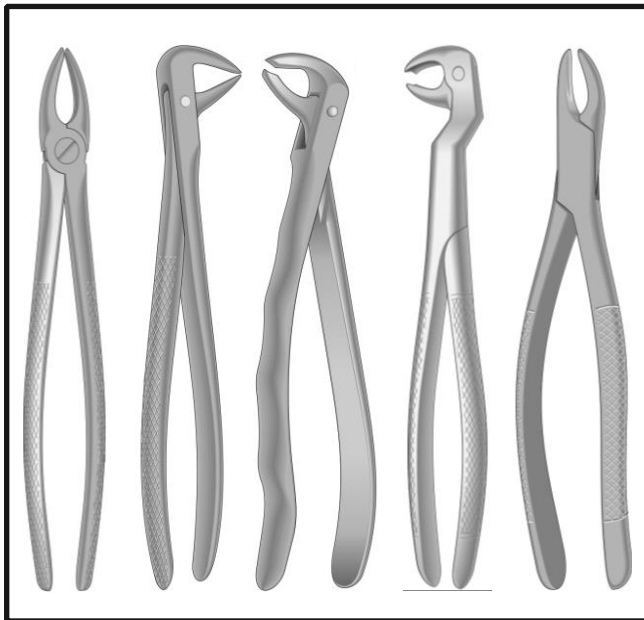
333 **Instrument Maintenance | Sterilization**

Instrumentenwartung | Sterilisierung
Entretien des instruments | Stérilisation
Mantenimiento | Esterilización
Manutenzione | Sterilizzazione

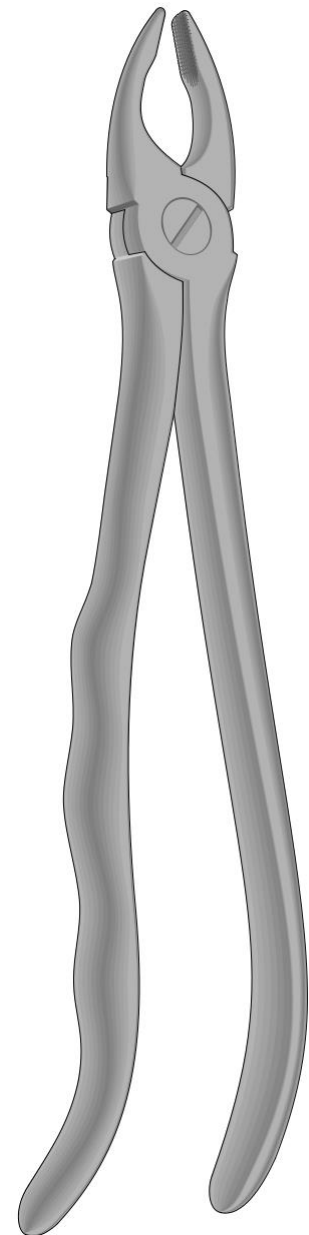
Email: sheffieldsurgicalinstruments@gmail.com

Web: www.sheffieldsurgicalinst.com

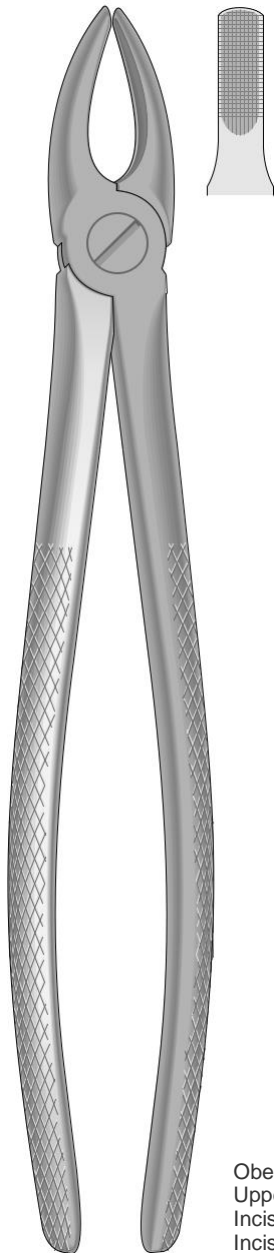
Extracting Forceps
Zahnzangen
Daviers
Pinzas de extracción
Pinze da estrazione



Sheffield Surgical is highly experienced Manufacturer & exporter of high quality Dental Instruments and also in the field of General Surgery, Bone Surgery an Orthopedic Instruments.



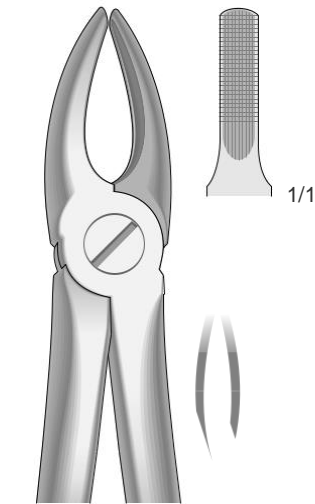
Zahnzangen, Englische Form
 Extracting Forceps, English Pattern
 Pinze per estrazione, Forma Inglese
 Pinzas da extracción, Forma Inglesa
 Daviers, Forme Anglaise



SSI-1
 Fig. 1

Obere Schneide- und Eckzähne
 Upper Incisors and cuspids
 Incisivi e canini superiori
 Incisivos y caninos superiores
 Incisives et canines supérieures

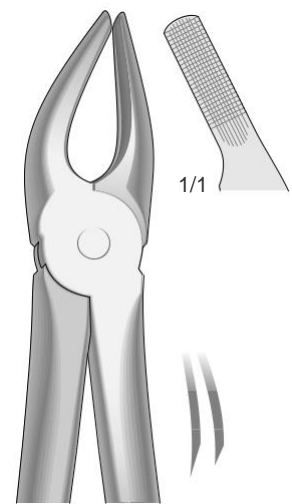
1/1



SSI-2
 Fig. 2

Obere Schneide- und Eckzähne
 Upper Incisors and cuspids
 Incisivi e canini superiori
 Incisivos y caninos superiores
 Incisives et canines supérieures

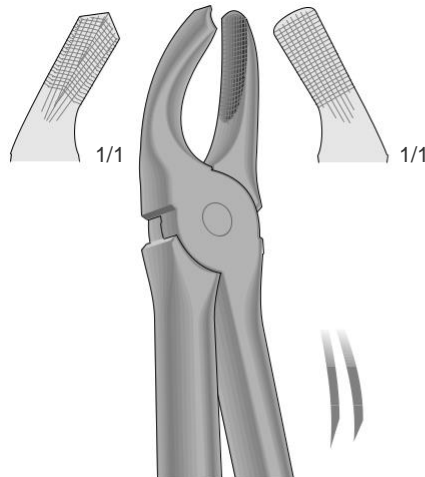
1/1



SSI-7
 Fig. 7

Obere Prämolaren
 Upper premolars
 Premolari superiori
 Premolares superiores
 Prémolaires supérieures

1/1

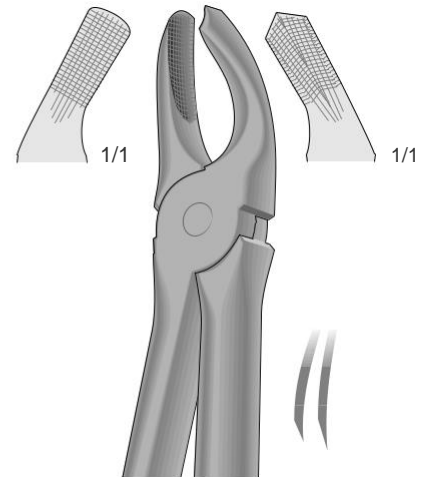


SSI-17
 Fig. 17

Obere Molaren, rechts
 Upper molars, right
 Molari superiori, destra
 Molares superiores, derechos
 Molaires supérieures, droites

1/1

1/1

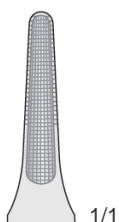


SSI-18
 Fig. 18

Obere Molaren, links
 Upper molars, left
 Molari superiori, sinistra
 Molares superiores, izquierdos
 Molaires supérieures, gauches

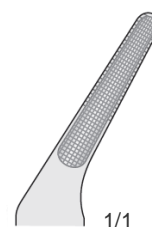
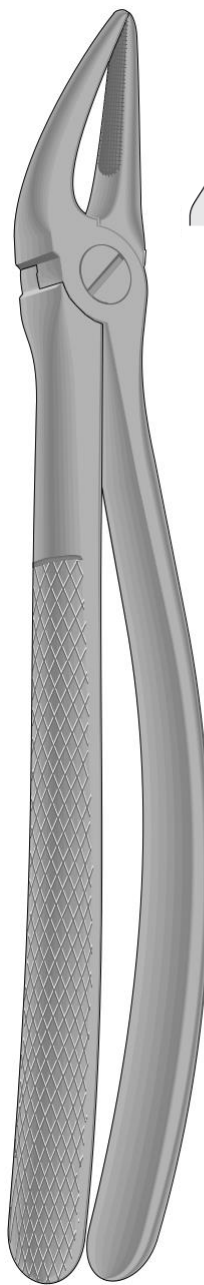
1/1

1/1



Obere Wurzeln und Schneidezähne
 Upper Roots and incisors
 Radici e incisivi superiori
 Raíces y incisivos superiores
 Racines et incisives supérieures

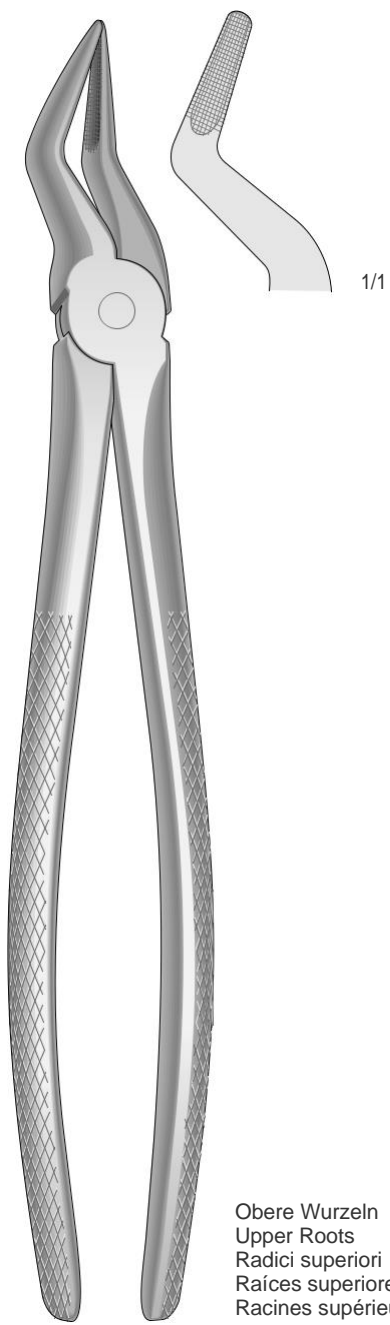
SSI-29
 Fig. 29



Obere Wurzeln
 Upper Roots
 Radici superiori
 Raíces superiores
 Racines supérieures

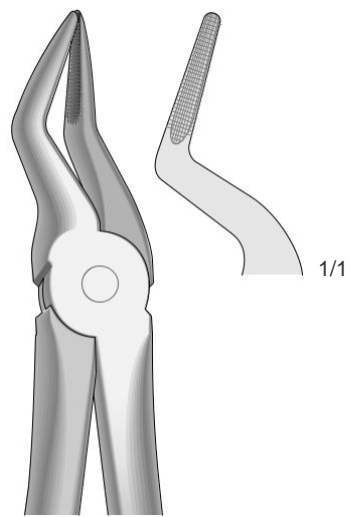
SSI-30
 Fig. 30

Zahnzangen, Englische Form
 Extracting Forceps, English Pattern
 Pinze per estrazione, Forma Inglese
 Pinzas da extracción, Forma Inglesa
 Daviers, Forme Anglaise



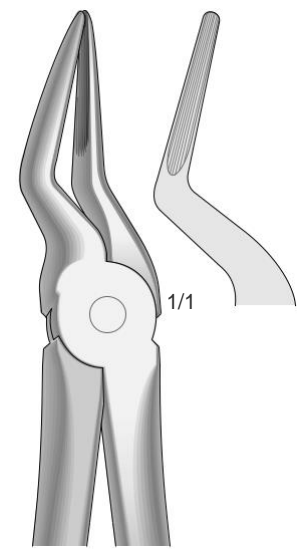
SSI-51
 Fig. SSI-51

Obere Wurzeln
 Upper Roots
 Radici superiori
 Raíces superiores
 Racines supérieures



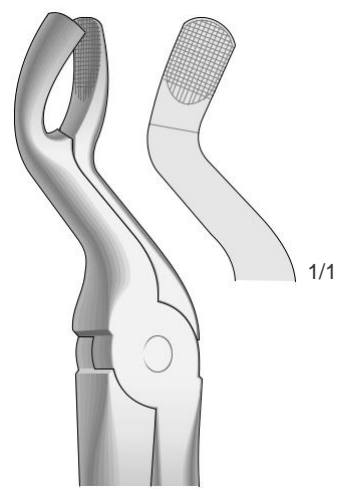
SSI-51A
 Fig. SSI-51A

Obere Wurzeln
 Upper Roots
 Radici superiori
 Raíces superiores
 Racines supérieures



SSI-51L
 Fig. SSI-51AL

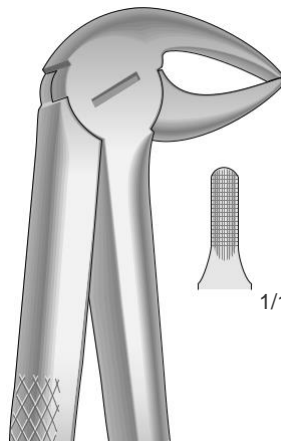
Obere Wurzeln
 Upper Roots
 Radici superiori
 Raíces superiores
 Racines supérieures



67A
 Fig. 67A

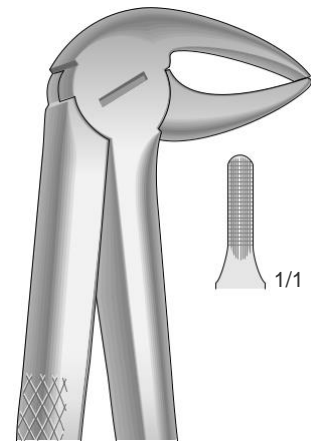
Obere Dritte Molaren - Für Obere Weisheitszähne
 Upper molars - For Upper wisdom teeth
 Ottavi superiori - Per denti del giudizio superiori
 Molares superiores - Para muelas del juicio superiores
 Molaires supérieures - Pour dents de sagesse supérieures

Zahnzangen, Englische Form
 Extracting Forceps, English
 PatternPinze per estrazione, Forma
 Inglese Pinzas da extracción,
 Forma Inglesa Daviers, Forme
 Anglaise



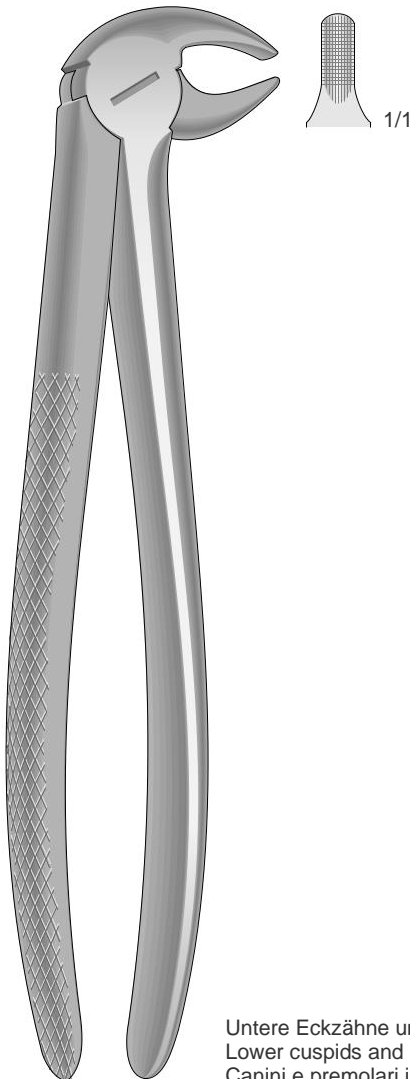
SSI-33
 Fig. 33

Untere Prämolaren, Schneidezähne und
 Wurzeln Lower incisors, premolars and roots
 Incisivi, premolari e radici inferiori
 Incisivos, premolares y raíces inferiores
 Incisives, prémolaires et racines inférieures



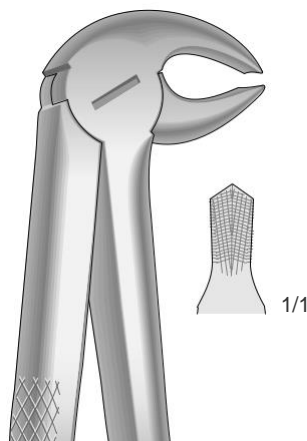
SSI-33A
 Fig. 33A

Untere Wurzeln, schlankes Maul Lower
 roots, Slender jaw Radici inferiori,
 morso stretto Raíces inferiores, boca
 estrecha Racines inférieures, avec un
 bec très fin



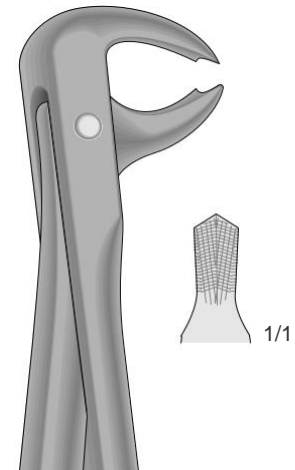
SSI-13

Untere Eckzähne und Prämolaren
 Lower cuspids and premolars
 Canini e premolari inferiori
 Caninos y premolares inferiores
 Canines et prémolaires inférieures



SSI-22
 Fig. 22

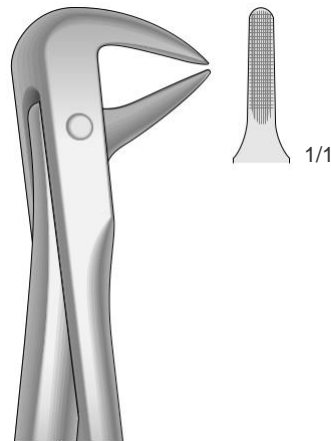
Untere Molaren
 Lower molars
 Molari inferiori
 Molares inferiores
 Molaires inférieures



SSI-73
 Fig. 73

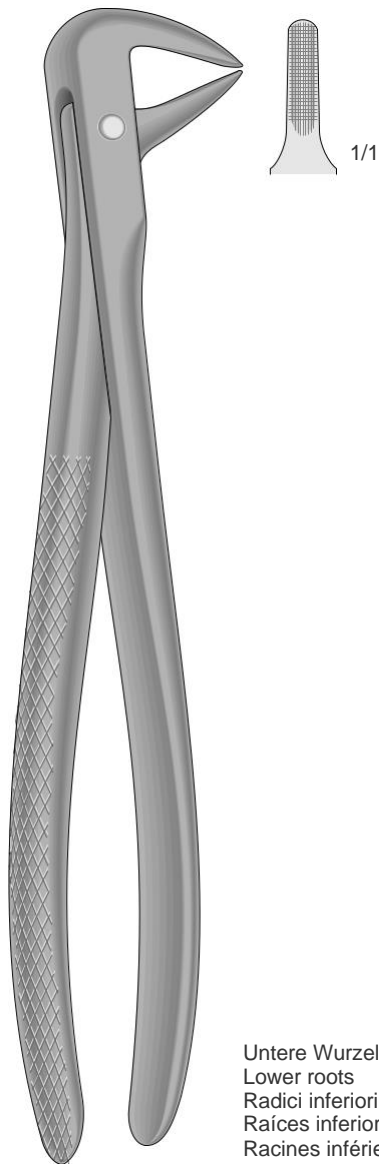
Untere Molaren
 Lower molars
 Molari inferiori
 Molares inferiores
 Molaires inférieures

Zahnzangen, Englische Form
 Extracting Forceps, English Pattern
 Pinze per estrazione, Forma Inglese
 Pinzas da extracción, Forma Inglesa
 Daviers, Forme Anglaise



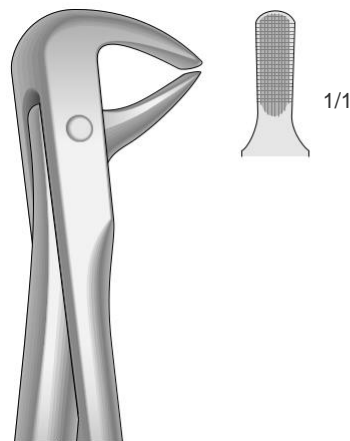
SSI-74N
 Fig. 74N

Untere Wurzeln, schneide-und Eckzähne
 Lower roots, Incisors and bicuspid
 Radici, incisivi e canini inferiori
 Raíces, incisivos y caninos inferiores
 Racines, incisives et canines inférieures



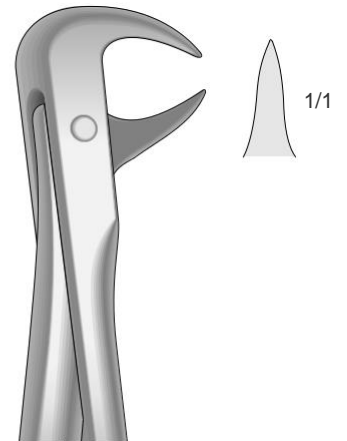
SSI-74
 Fig. 74

Untere Wurzeln
 Lower roots
 Radici inferiori
 Raíces inferiores
 Racines inférieures



SSI-75
 Fig. 75

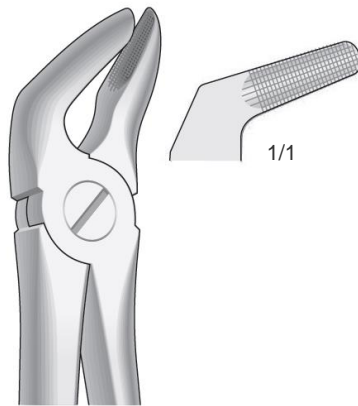
Untere Eckzähne und Prämolaren
 Lower Cuspids and bicuspid
 Canini e premolari inferiori
 Caninos y premolares inferiores
 Canines et prémolaires inférieures



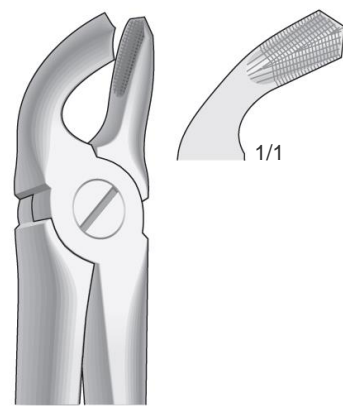
SSI-86A
 Fig. 86A

Untere Molaren
 Lower molars
 Molari inferiori
 Molares inferiores
 Molaires inférieures

Zahnzangen, Englische Form
 Extracting Forceps, English Pattern
 Pinze per estrazione, Forma Inglese
 Pinzas da extracción, Forma Inglesa
 Daviers, Forme Anglaise



SSI-8
 Fig. 8
 Untere Prämolaren
 Lower premolars
 Premolari inferiori
 Premolares inferiores
 Prémolaires inférieures

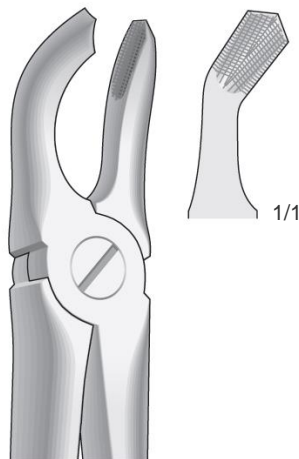


SSI-21
 Fig. 21
 Untere Weisheitszähne und Molaren
 Lower wisdom teeth and molars
 Denti del giudizio e molari inferiori
 Muelas del juicio y Molares inferiores
 Dents de sagesse et molaires inférieures

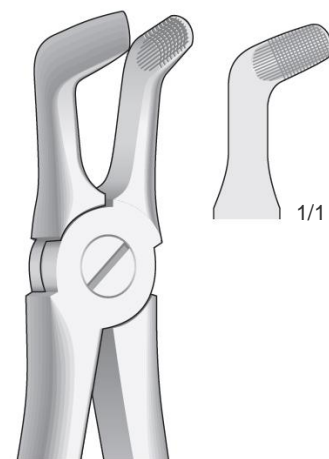


SSI-4
 Fig. 4

Untere Schneide- und Eckzähne
 Lower Incisors and cuspids
 Incisivi e canini inferiori
 Incisivos y caninos inferiores
 Incisives et canines inférieures



SSI-79
 Fig. 79
 Untere Weisheitszähne
 Lower wisdom teeth
 Denti del giudizio inferiori
 Muelas del juicio inferiores
 Dent de sagesse inférieures



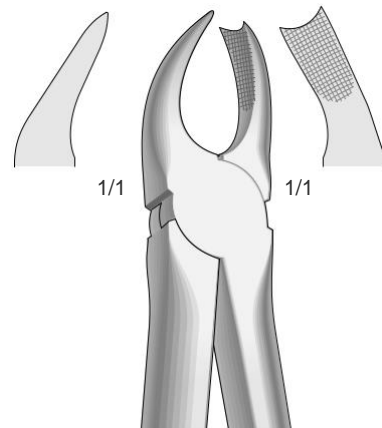
SSI-79A
 Fig. 79A
 Untere Molaren und Weisheitszähne
 Lower molars and wisdom teeth
 Molari e denti del giudizio inferiori
 Molares y muelas del juicio inferiores
 Molaires et dent de sagesse inférieures

Zahnzangen, Englische Form
 Extracting Forceps, English Pattern
 Pinze per estrazione, Forma Inglese
 Pinzas da extracción, Forma Inglesa
 Daviers, Forme Anglaise



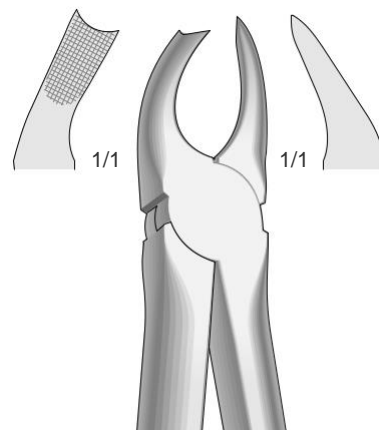
SSI-87
 Fig. 87

Untere Molaren
 Lower molars
 Molari inferiori
 Molares inferiores
 Molaires inférieures



SSI-89
 Fig. 89

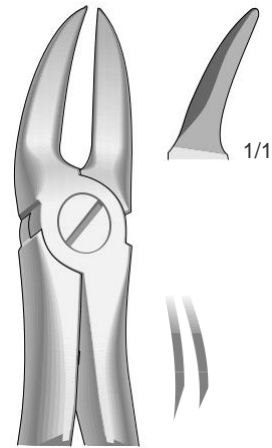
Obere Molaren, rechts
 Upper molars, right
 Molari superiori, destra
 Molares superiores, derechos
 Molaires supérieures, droites



SSI-90
 Fig. 90

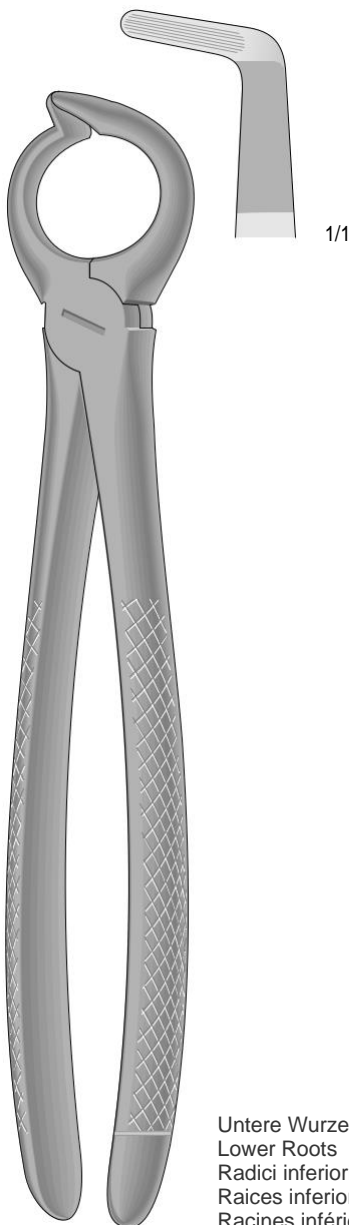
Obere Molaren, links
 Upper molars, left
 Molari superiori, sinistra
 Molares superiores, izquierdos
 Molaires supérieures, gauches

Zahnzangen, Englische Form
 Extracting Forceps, English Pattern
 Pinze per estrazione, Forma Inglese
 Pinzas da extracción, Forma Inglesa
 Daviers, Forme Anglaise



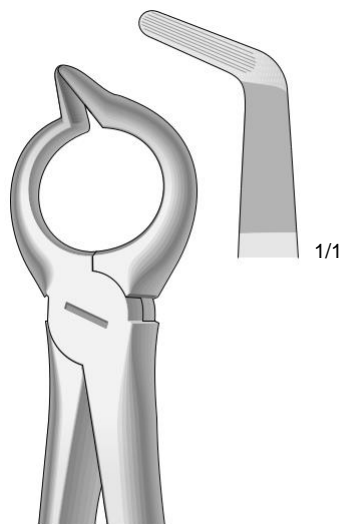
SSI-55
 Fig. 55

Zum Trennen oberer Molarenwurzeln
 For separating upper molar roots
 Per radici dei molari superiori, presa in profondità
 Para partir raíces de molares superiores, profundo
 Pour séparer les racines des molaires supérieures



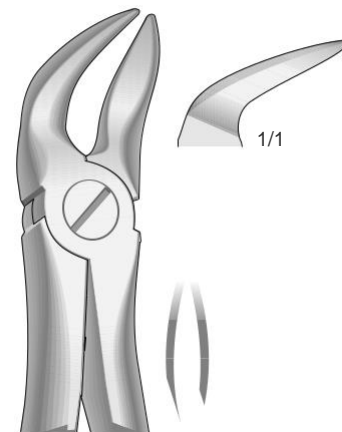
SSI-68
 Fig. 68

Untere Wurzeln
 Lower Roots
 Radici inferiori
 Raíces inferiores
 Racines inférieures



SSI-68A
 Fig. 68A

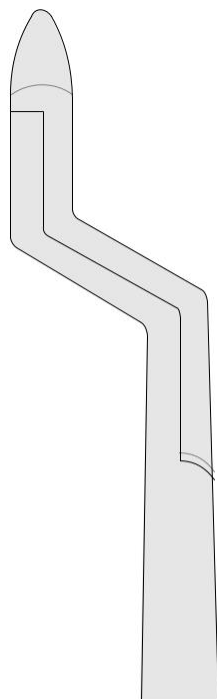
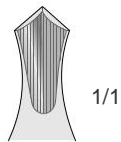
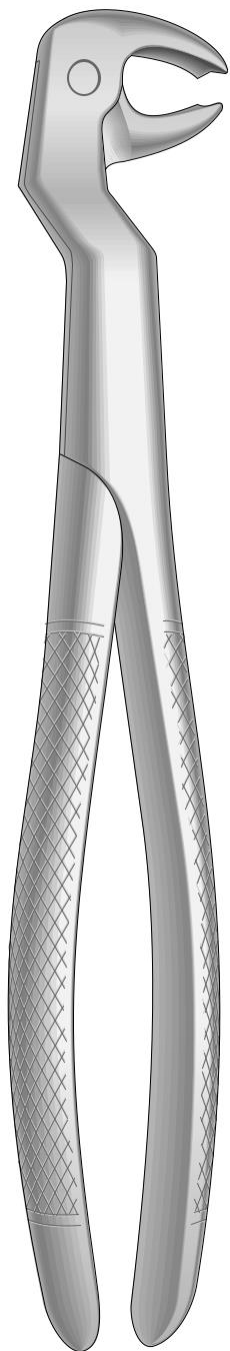
Untere Wurzeln
 Lower Roots
 Radici inferiori
 Raíces inferiores
 Racines inférieures



SSI-56
 Fig. 56

Zum Trennen Unterer Molarenwurzeln
 For separating lower molar roots
 Per radici dei molari inferiori, presa in profondità
 Para partir raíces de molares inferiores, profundo
 Pour séparer les racines des molaires inférieures

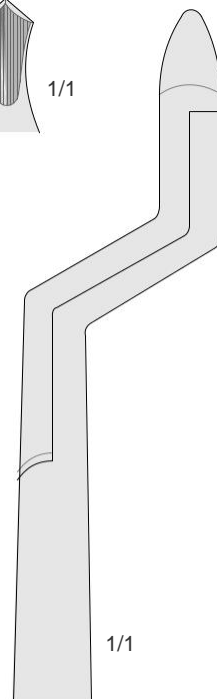
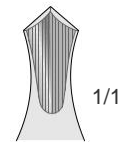
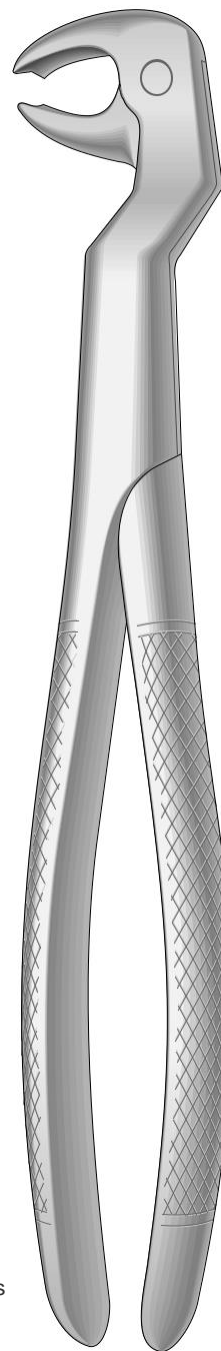
Zahnzangen, Englische Form
 Extracting Forceps, English Pattern
 Pinze per estrazione, Forma Inglese
 Pinzas da extracción, Forma Inglesa
 Daviers, Forme Anglaise



1/1

Untere Molaren und Weisheitszähne, rechts
 Lower molars and wisdom teeth, right
 Molari e denti del giudizio inferiori, a destra
 Molares y muelas del juicio inferiores, derecha
 Molaires et dent de sagesse inférieures, droites

ROUTURIER
 SSI-22 1/2 R

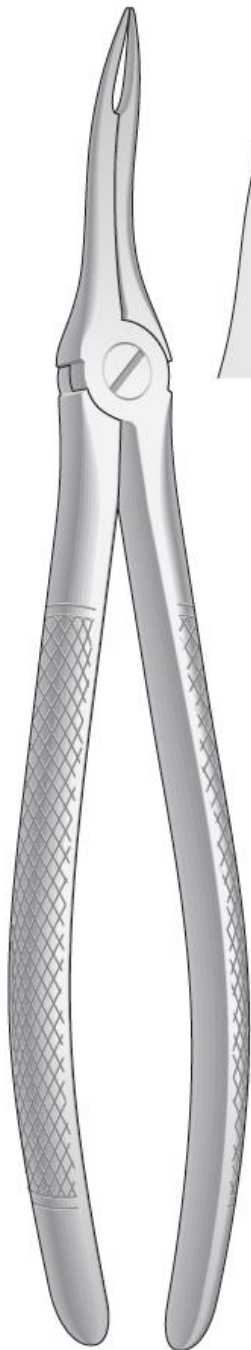


1/1

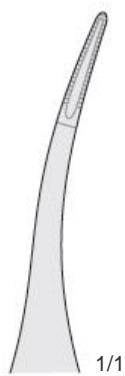
Untere Molaren und Weisheitszähne, links
 Lower molars and wisdom teeth, left
 Molari e denti del giudizio inferiori, a sinistra
 Molares y muelas del juicio inferiores, izquierda
 Molaires et dent de sagesse inférieures, gauches

ROUTURIER
 SSI-22 1/2 L

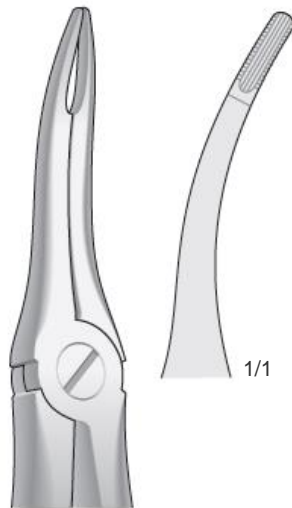
Email: sheffieldsurgicalinstruments@gmail.com
 Web: www.sheffieldsurgicalinst.com



SSI-49
 Fig. 49

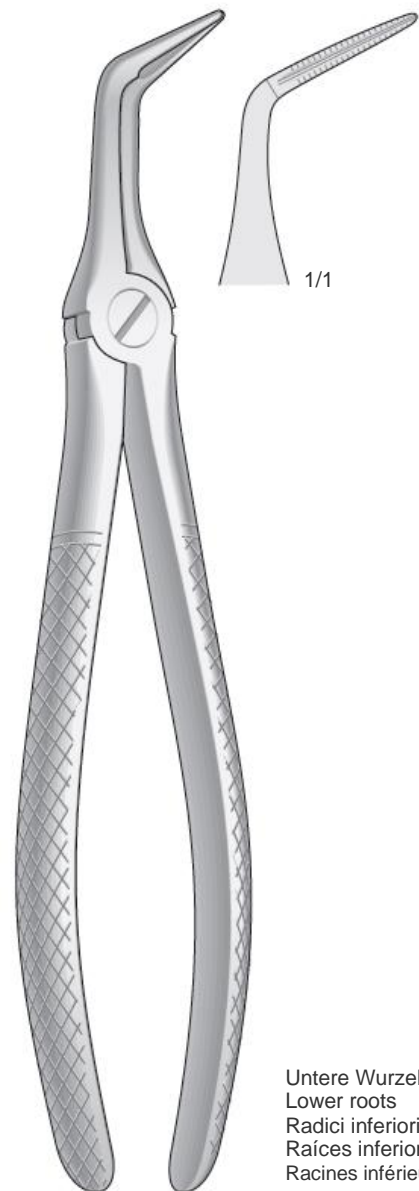
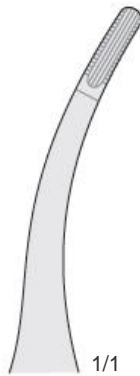


Obere Wurzeln sehr feine
 Upper very fine roots
 Radici superiori molto sottili
 Raíces superiores muy finas
 Racines supérieures très fines



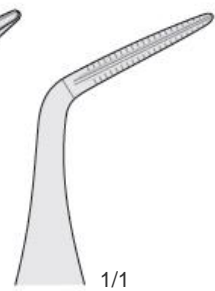
SSI-48
 Fig. 48 - 44

Obere Wurzeln
 Upper roots
 Radici superiori
 Raíces superiores
 Racines supérieures

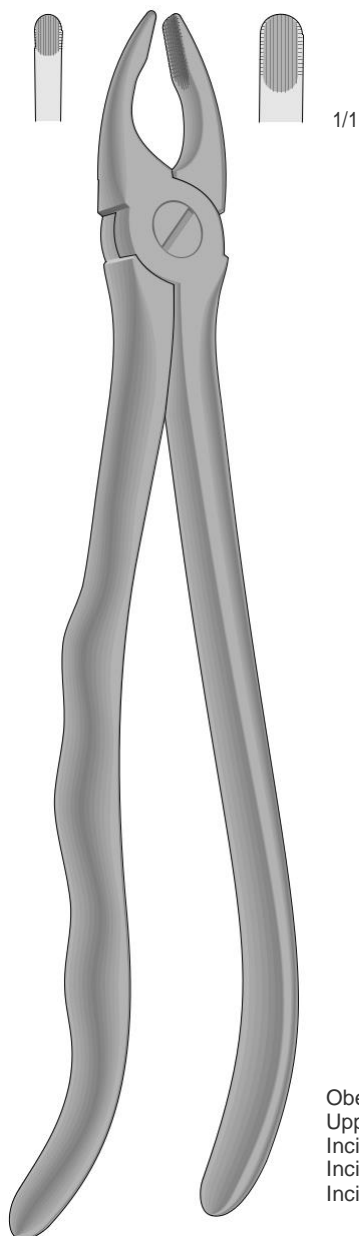


SSI-46L
 Fig. 4

Untere Wurzeln
 Lower roots
 Radici inferiori
 Raíces inferiores
 Racines inférieures

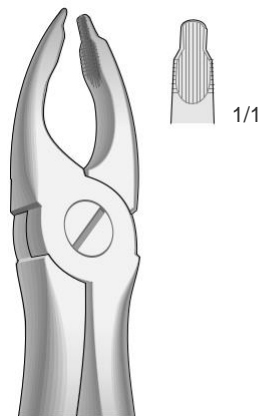


Zahnzangen, Paßformgriff
 Extracting Forceps, Anatomical Handle
 Pinze per estrazione, Manico anatomico
 Pinzas da extracción, Mango anatómico
 Daviers, Manche anatomique



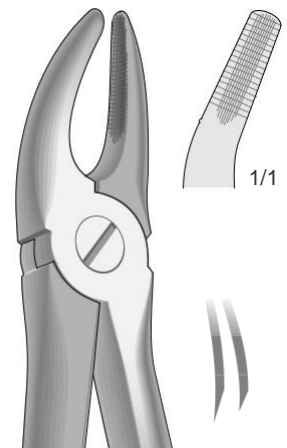
SSI-S-3AN
 Fig. 3

Obere Schneide- und Eckzähne
 Upper incisors and cuspids
 Incisivi e canini superiori
 Incisivos y caninos superiores
 Incisives et canines supérieures



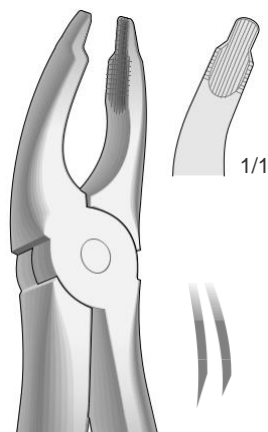
SSI-S-34
 Fig. 34

Obere Schneide- und Eckzähne
 Upper incisors and cuspids
 Incisivi e canini superiori
 Incisivos y caninos superiores
 Incisives et canines supérieures



SSI-S-7
 Fig. 7

Obere Prämolaren
 Upper premolars
 Premolari superiori
 Premolares superiores
 Prémolaires supérieures

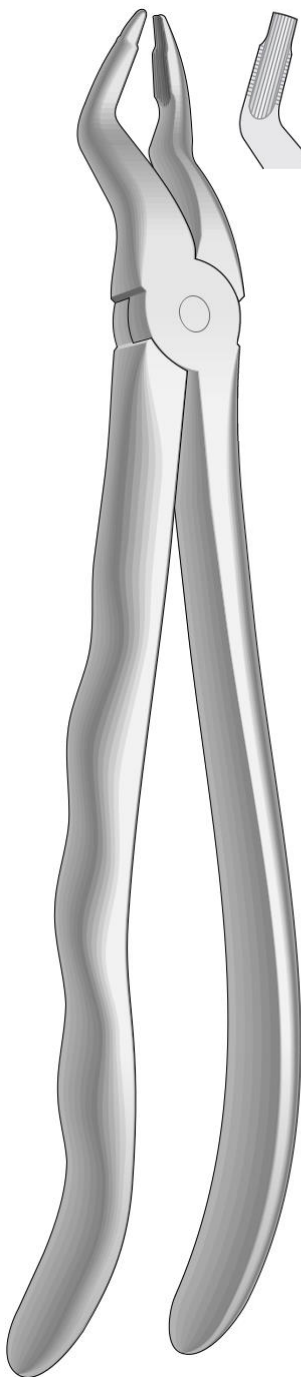


SSI-S-35
 Fig. 35

Obere Schneidezähne und Prämolaren, tiefgreifend
 Upper incisors and bicuspid, deep-gripping
 Incisivi e premolari superiori, presa in profondità
 Incisivos y premolares superiores, a gran calado
 Incisives et prémolaires supérieures, à attaque profonde

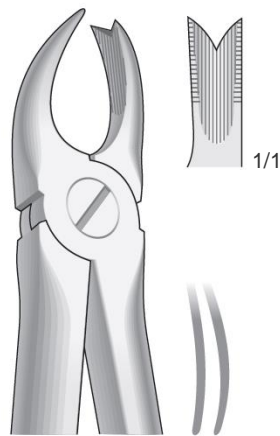
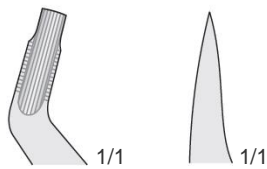


Zahnzangen, Paßformgriff
 Extracting Forceps, Anatomical Handle
 Pinze per estrazione, Manico anatomico
 Pinzas da extracción, Mango anatómico
 Daviers, Manche anatomique



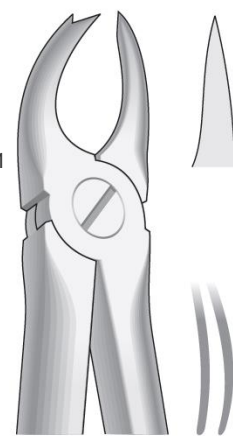
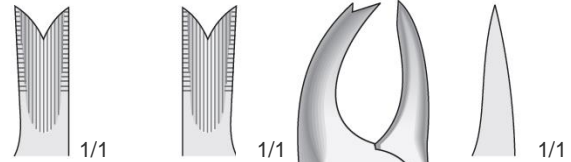
SSI-S-31
 Fig. 31

Obere Prämolaren
 Upper premolars
 Premolari superiori
 Premolares superiores
 Prémolaires supérieures



SSI-S-66R
 Fig. 66R (89)

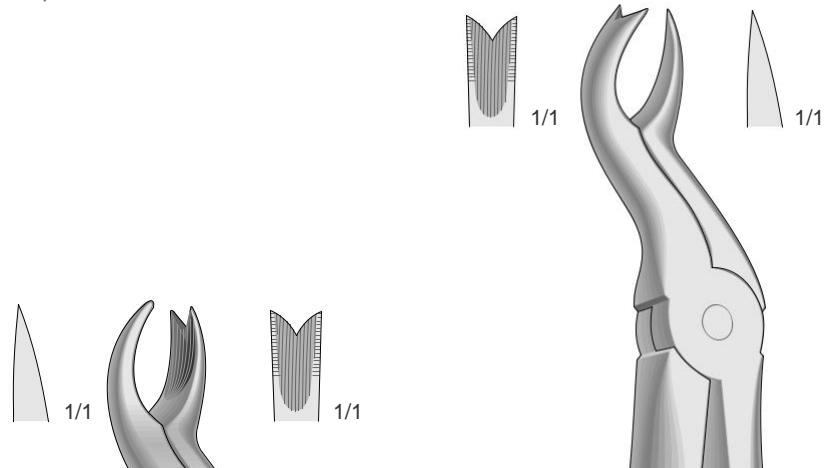
Obere Molaren, rechts
 Upper molars, right
 Molari superiori, destra
 Molares superiores, derechos
 Molaires supérieures, droites



SSI-S-66L
 Fig. 66L (90)

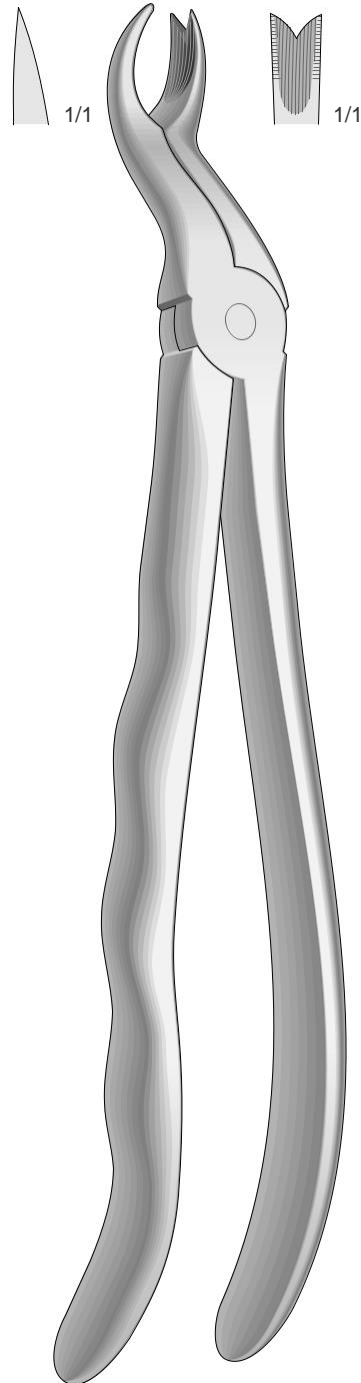
Obere Molaren, links
 Upper molars, left
 Molari superiori, sinistra
 Molares superiores, izquierdos
 Molaires supérieures, gauches

Zahnzangen, Paßformgriff
 Extracting Forceps, Anatomical Handle
 Pinze per estrazione, Manico anatomico
 Pinzas da extracción, Mango anatómico
 Daviers, Manche anatomique



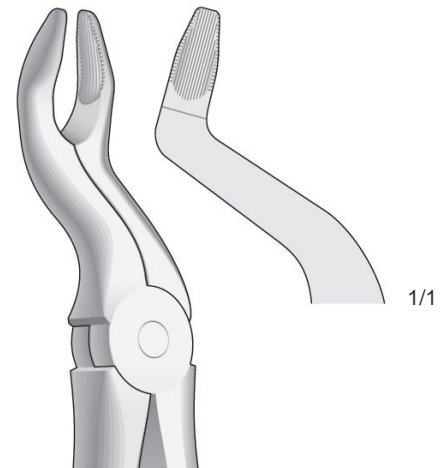
SSI-S-67L
 Fig. 67L

Obere Molaren, links
 Upper molars, left
 Molari superiori, sinistra
 Molares superiores, izquierdos
 Molaires supérieures, gauches



SSI-S-67R
 Fig. 67R

Obere Molaren, rechts
 Upper molars, right
 Molari superiori, destra
 Molares superiores, derechos
 Molaires supérieures, droites



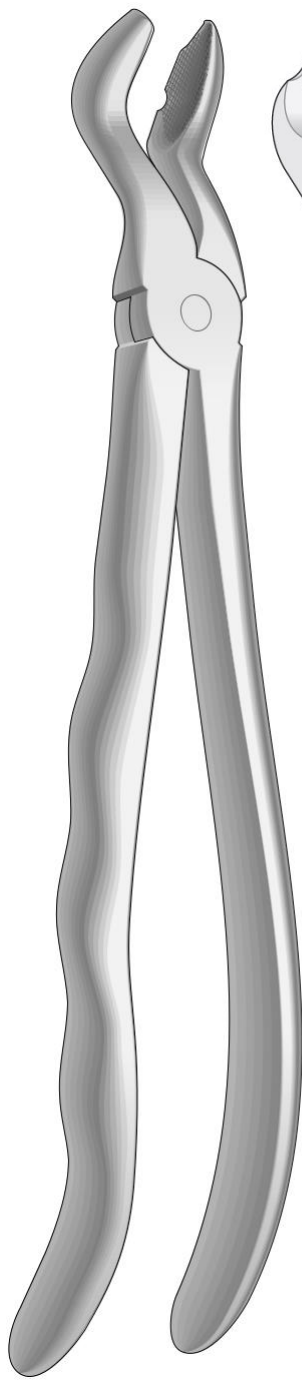
SSI-S-67N
 Fig. 67N

Obere Molaren
 Upper molars
 Molari superiori
 Molares superiores
 Molaires supérieures

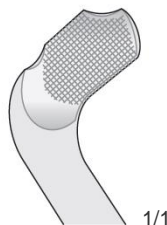
Email: sheffieldsurgicalinstruments@gmail.com
 Web: www.sheffieldsurgicalinst.com



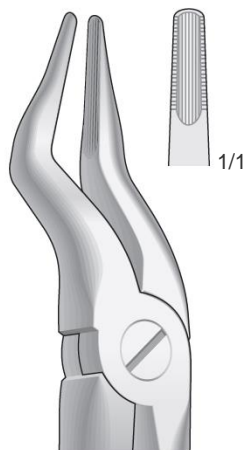
Zahnzangen, Paßformgriff
 Extracting Forceps, Anatomical Handle
 Pinze per estrazione, Manico anatomico
 Pinzas da extracción, Mango anatómico
 Daviers, Manche anatomique



FELSCH
 SSI-S-80
 Fig. 80

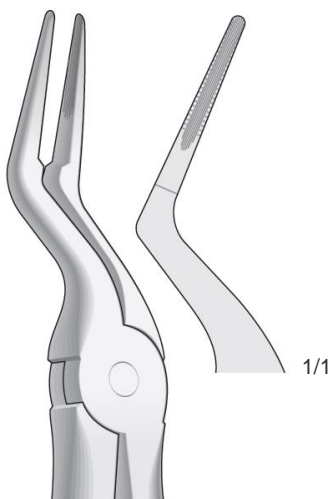


Für obere Weisheitszähne, mit Fangvorrichtung
 For upper wisdom teeth, with retaining device
 Denti del giudizio superiori, con dispositivo di presa
 Muelas del juicio superiores, con dispositivo de retencion
 Pour dents de sagesse supérieures, mors conçus pour recueillir la dent



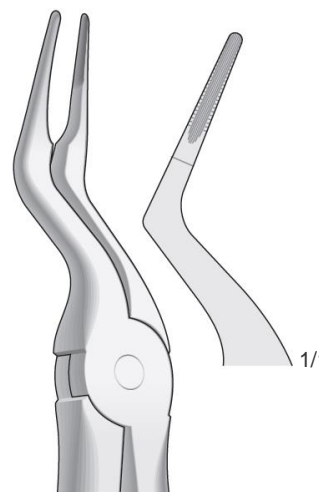
SSI-S-51B
 Fig. SSI-51B

Obere Dritte Molaren
 Upper molars
 Ottavi superiori
 Molares superiores
 Molaires supérieures



SSI-S-97
 Fig. 97

Obere Wurzelplitterzange
 Upper Root Fragments
 Frammenti e radici superiori
 Fragmentos de raíces superiores
 Fragments des racines supérieures

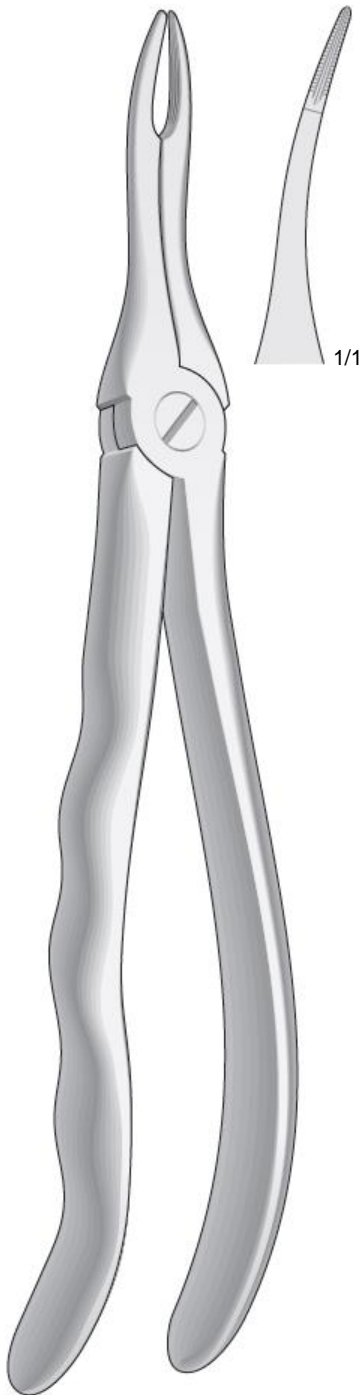


SSI-S-97B
 Fig. 97B

Obere Wurzelplitterzange Upper
 Root Fragments Frammenti e
 radici superiori Fragmentos de
 raíces superiores Fragments des
 racines supérieures

Zahnzangen, Paßformgriff
 Extracting Forceps, Anatomical Handle
 Pinze per estrazione, Manico anatomico
 Pinzas da extracción, Mango anatómico
 Daviers, Manche anatomique

Obere Wurzeln sehr feine
 Upper very fine roots
 Radici superiori molto sottili
 Raíces superiores muy finas
 Racines supérieures très fines



SSI-S-49
 Fig. 49

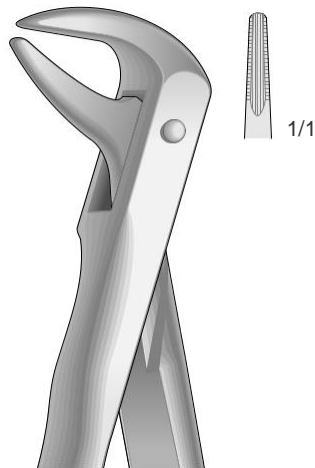


SSI-S-51LX
 Fig. 51LX



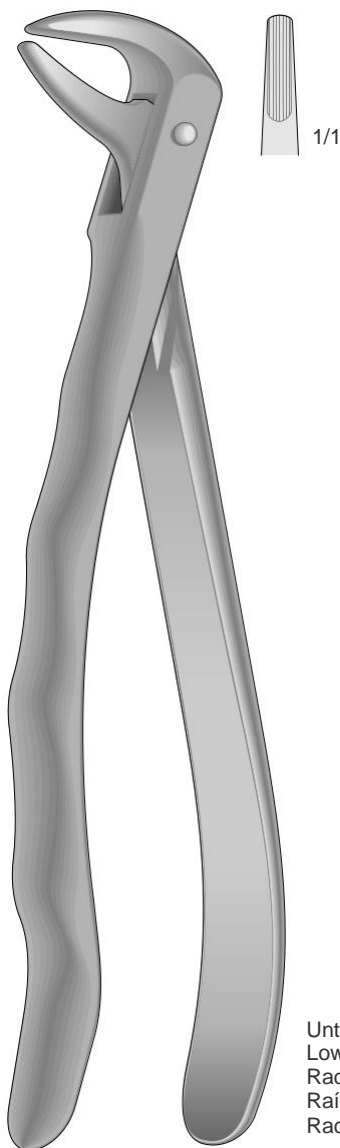
SSI-S-351S
 Fig. 351S

Zahnzangen, Paßformgriff
 Extracting Forceps, Anatomical Handle
 Pinze per estrazione, Manico anatomico
 Pinzas da extracción, Mango anatómico
 Daviers, Manche anatomique

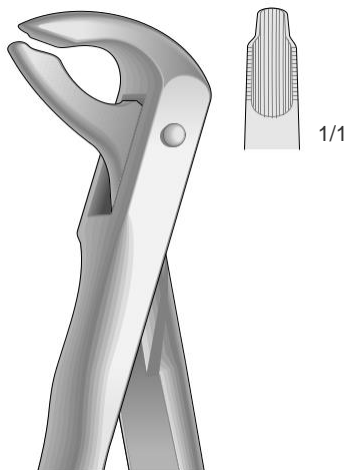


SSI-I-74N
 Fig. 74N

Untere Wurzeln Schneide- und Eckzähne
 Lower roots, incisors and cuspids
 Radici, incisivi e canini inferiori
 Raíces, incisivos y caninos inferiores
 Racines, incisives et canines inférieures

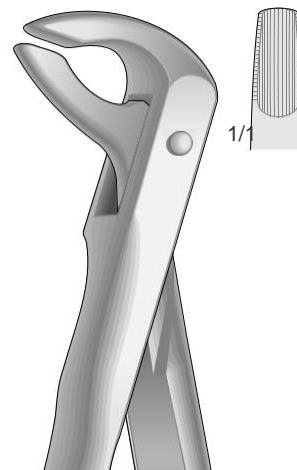


SSI-I-74
 Fig. 74



SSI-I-36
 Fig. 36

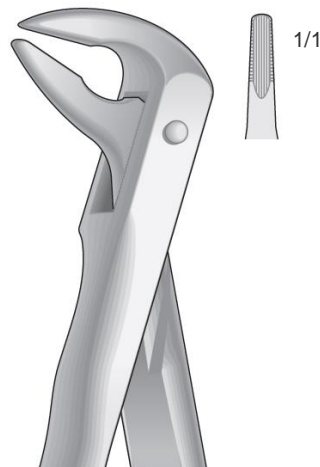
Untere Wurzeln Schneide- und Eckzähne
 Lower roots, incisors and cuspids
 Radici, incisivi e canini inferiori
 Raíces, incisivos y caninos inferiores
 Racines, incisives et canines inférieures



SSI-I-36N
 Fig. 36N

Untere Wurzeln Schneide- und Eckzähne
 Lower roots, incisors and cuspids
 Radici, incisivi e canini inferiori
 Raíces, incisivos y caninos inferiores
 Racines, incisives et canines inférieures

Zahnzangen, Paßformgriff
 Extracting Forceps, Anatomical Handle
 Pinze per estrazione, Manico anatomico
 Pinzas da extracción, Mango anatómico
 Daviers, Manche anatomique



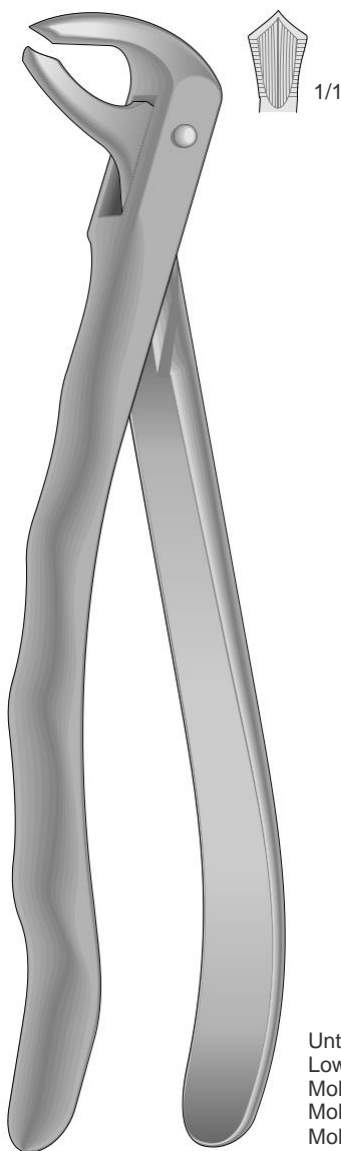
SSI-I-59
 Fig. 59

Untere Wurzelpitterzange
 Lower Root Fragments
 Frammenti e radici inferiori
 Fragmentos de raíces inferiores
 Fragments des racines inférieures



SSI-I-86C
 Fig. 86C

Untere Molaren mit kariesen oder abgebrochenen
 Kronen Lower molars with carious or broken caps Molari
 inferiori con corone cariate o spezzate
 Molares inferiores con coronas rotas o cariadas
 Molaires inférieures avec couronnes cariées ou cassées



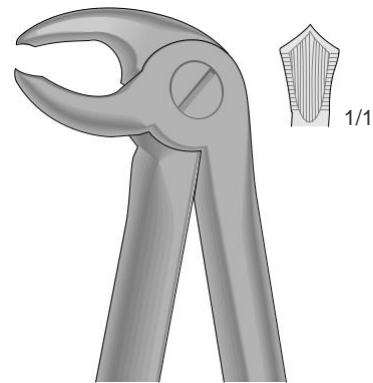
SSI-I-73
 Fig. 73

Untere Molaren
 Lower molars
 Molari inferiori
 Molares inferiores
 Molaires inférieures



SSI-I-13
 Fig. 13

Untere Prämolaren und Eckzähne
 Lower premolars and cuspids
 Canini e premolari inferiori
 Caninos y premolares inferiores
 Canines et prémolaires inférieures



SSI-I-22
 Fig. 22

Untere Molaren
 Lower molars
 Molari inferiori
 Molares inferiores
 Molaires inférieures

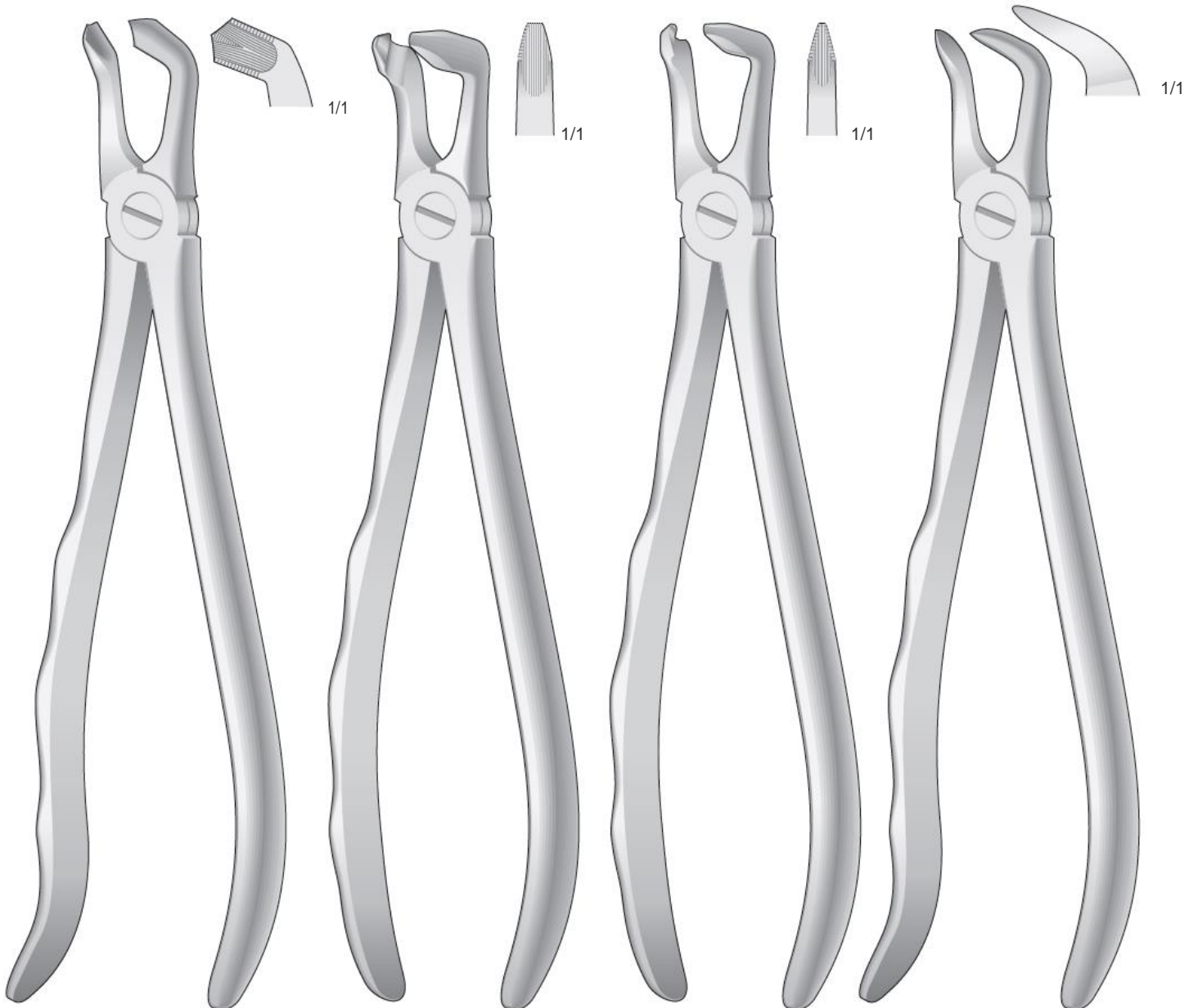


Zahnzangen, Paßformgriff
Extracting Forceps, Anatomical Handle
Pinze per estrazione, Manico anatomico
Pinzas da extracción, Mango anatómico
Daviers, Manche anatomique

Untere Weisheitszähne
Lower wisdom teeth
Denti del giudizio inferiori
Muelas del juicio inferiores
Dent de sagesse inférieures

Untere Prämolaren
Lower premolars
Premolari inferiori
Premolares inferiores
Prémolaires inférieures

Untere Molaren
Lower molars
Molari inferiori
Molares inferiores
Molaires inférieures



SSII-I-79
Fig. 79

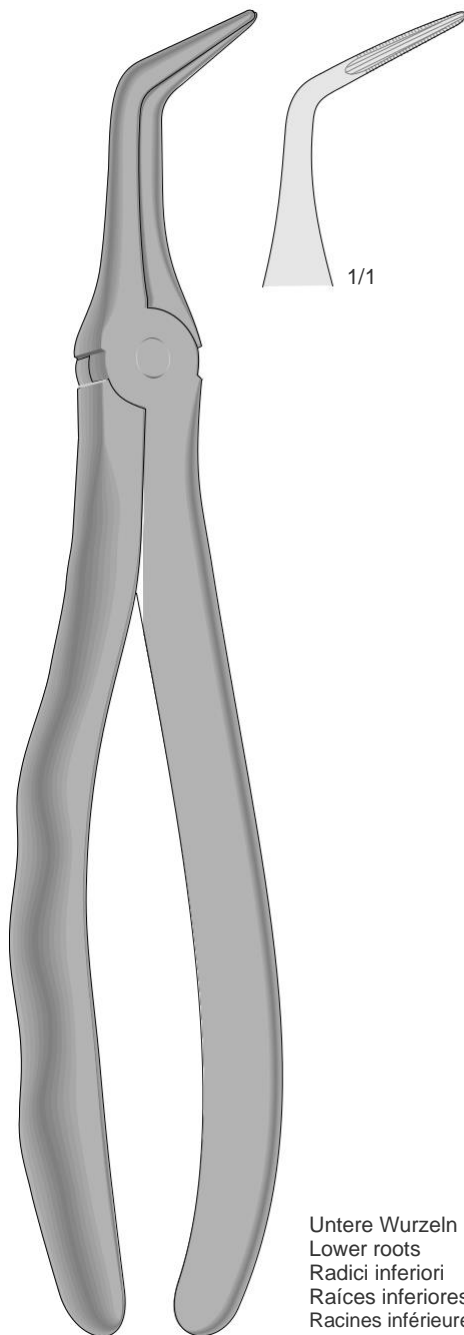
SSII-I-79N
Fig. 79N

SSII-I-46N
Fig. 46N

SSII-I-87
Fig. 87

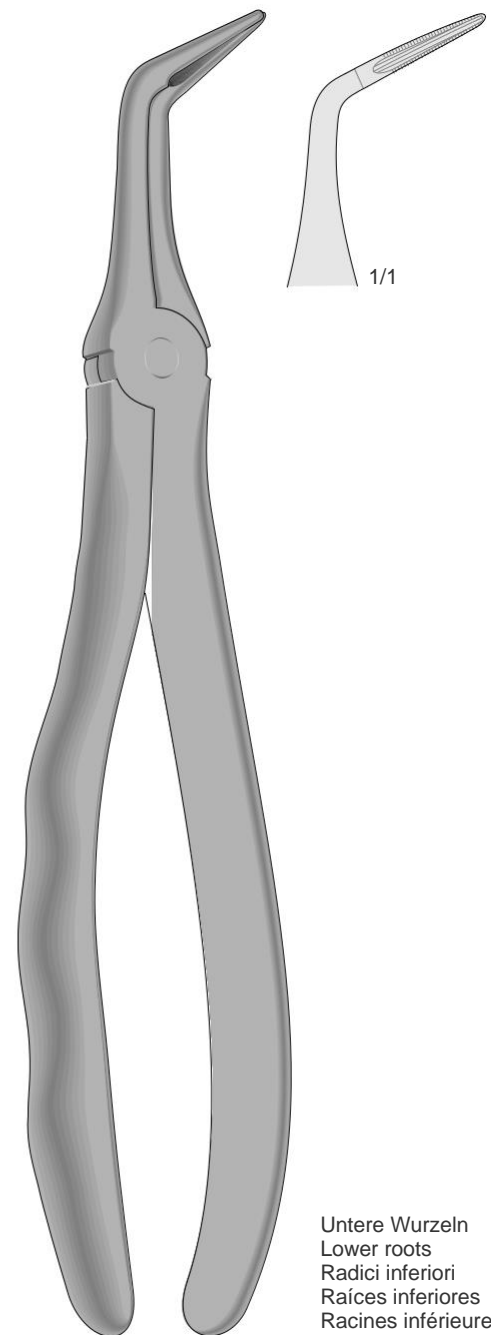
Email: sheffieldsurgicalinstruments@gmail.com
Web: www.sheffieldsurgicalinst.com

Zahnzangen, Paßformgriff
 Extracting Forceps, Anatomical Handle
 Pinze per estrazione, Manico anatomico
 Pinzas da extracción, Mango anatómico
 Daviers, Manche anatomique



SSI-I-46LX
 Fig. 46LX

Untere Wurzeln
 Lower roots
 Radici inferiori
 Raíces inferiores
 Racines inférieures



SSI-I-46L
 Fig. 46L

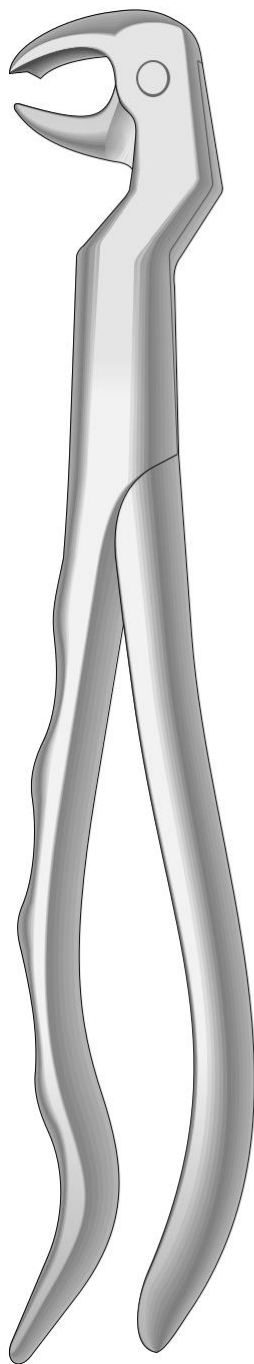
Untere Wurzeln
 Lower roots
 Radici inferiori
 Raíces inferiores
 Racines inférieures

Email: sheffieldsurgicalinstruments@gmail.com
 Web: www.sheffieldsurgicalinst.com



Zahnzangen, Paßformgriff
Extracting Forceps, Anatomical Handle
Pinze per estrazione, Manico anatomico
Pinzas da extracción, Mango anatómico
Daviers, Manche anatomique

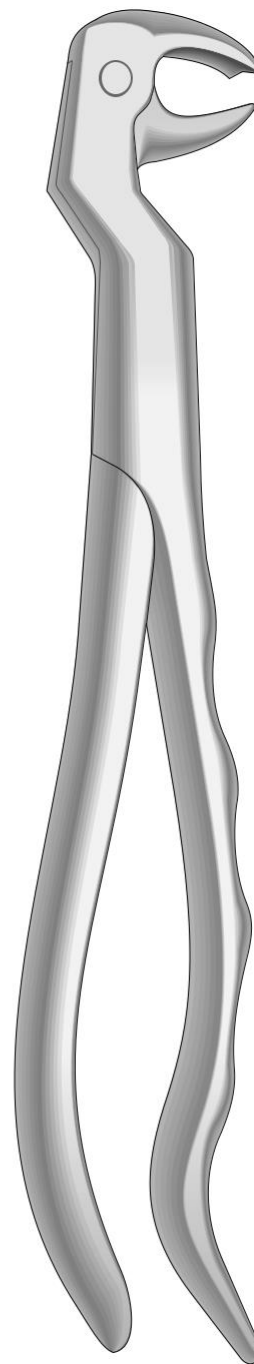
Untere Molaren und Weisheitszähne
Lower molars and wisdom teeth
Molari e denti del giudizio inferiori
Molares y muelas del juicio inferiores
Molaires et dent de sagesse inférieures



1/1

Links
Left
Sinistra
Izquierdos
Gauches

SSI-I-22 1/2 L



1/1

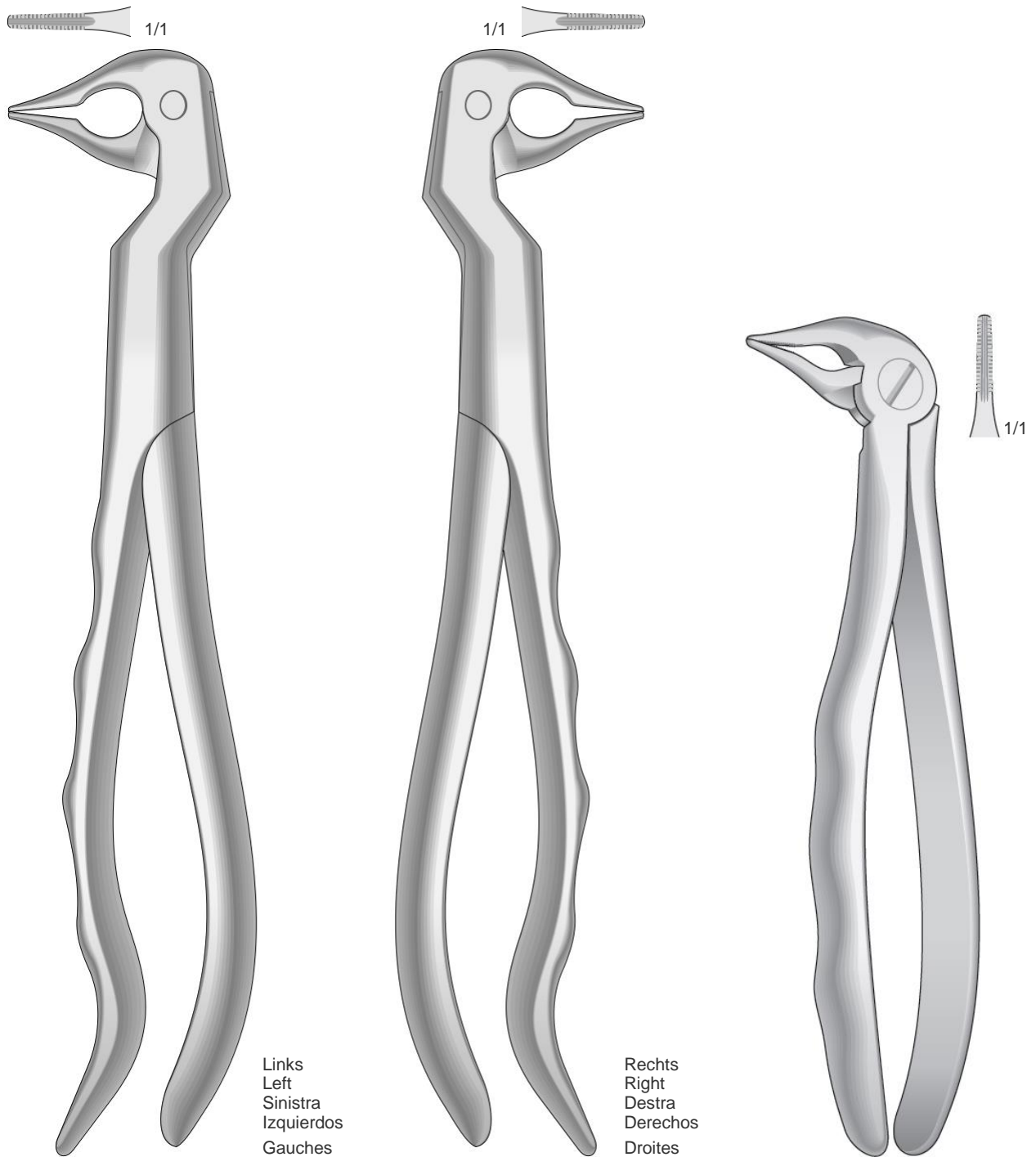
Rechts
Right
Destra
Derechos
Droites

SSI-I-22 1/2 R

Email: sheffieldsurgicalinstruments@gmail.com
Web: www.sheffieldsurgicalinst.com

Zahnzangen, Paßformgriff
 Extracting Forceps, Anatomical Handle
 Pinze per estrazione, Manico anatomico
 Pinzas da extracción, Mango anatómico
 Daviers, Manche anatomique

Untere Wurzeln sehr feine
 Lower very fine roots
 Radici inferiori molto sottili
 Raíces inferiores muy finas
 Racines inférieures très fines



SSI-I-133 L
 Fig.133

SSI-I-133 R
 Fig.133

SSI-333S
 Fig.333S

Links
 Left
 Sinistra
 Izquierdos
 Gauches

Rechts
 Right
 Destra
 Derechos
 Droites

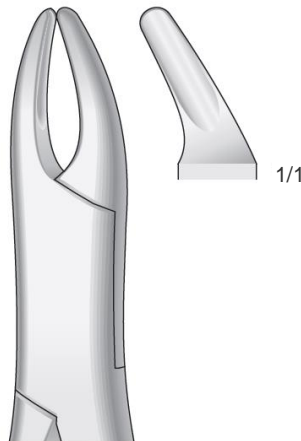
Email: sheffieldsurgicalinstruments@gmail.com
 Web: www.sheffieldsurgicalinst.com

Zahnzangen, Amerikanische Form
 Extracting Forceps, American Pattern
 Pinze per estrazione, Forma Americana
 Pinzas da extracción, Forma Americana
 Daviers, Forme Américaine



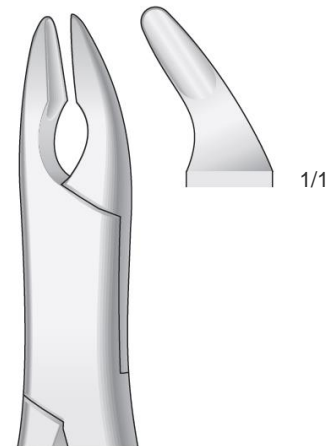
SSI-AM-1
 Fig. 1

Obere Schneide- und Eckzähne
 Upper incisors and cuspids
 Incisivi e canini superiori
 Incisivos y caninos superiores
 Incisives et canines supérieures



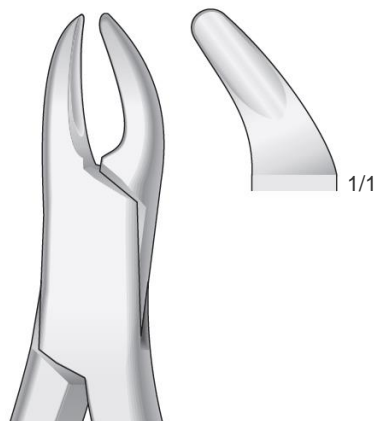
CRYER
SSI-AM-150
 Fig. 150

Obere Prämolaren, Schneidezähne,
 Wurzeln Upper Bicuspid, incisors and roots
 Premolari, incisivi e radici superiori
 Premolares, incisivos y raíces superiores
 Prémolaires, incisives et racines supérieures



CRYER
SSI-AM-150A
 Fig. 150A

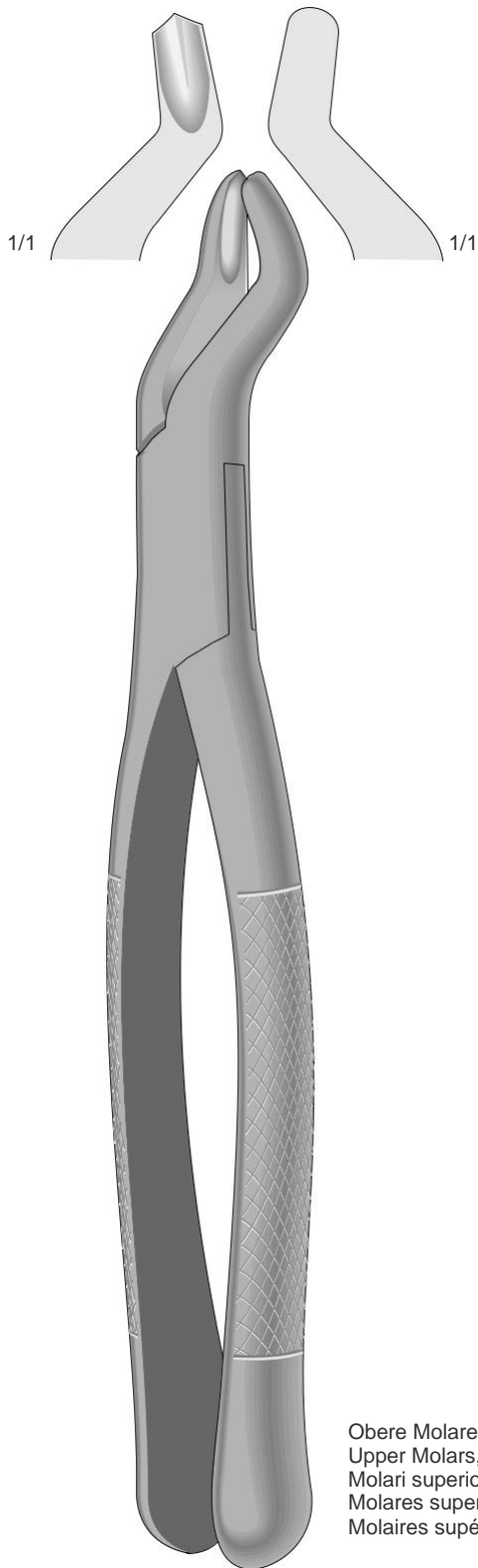
Obere Prämolaren, Schneidezähne,
 Wurzeln Upper Bicuspid, incisors and roots
 Premolari, incisivi e radici superiori
 Premolares, incisivos y raíces superiores
 Prémolaires, incisives et racines supérieures



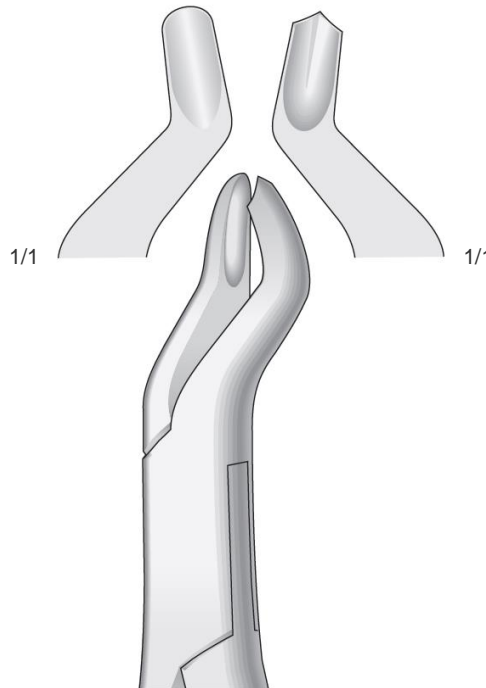
SSI-AM-62
 Fig. 62

Schneidezähne, Prämolaren, Milchzähne
 Incisors, premolars, deciduous teeth
 Incisivi, premolari, denti da latte
 Incisivos, premolares, dientes de leche
 Incisives, prémolaires, dents de lait

Zahnzangen, Amerikanische Form
 Extracting Forceps, American Pattern
 Pinze per estrazione, Forma Americana
 Pinzas da extracción, Forma Americana
 Daviers, Forme Américaine

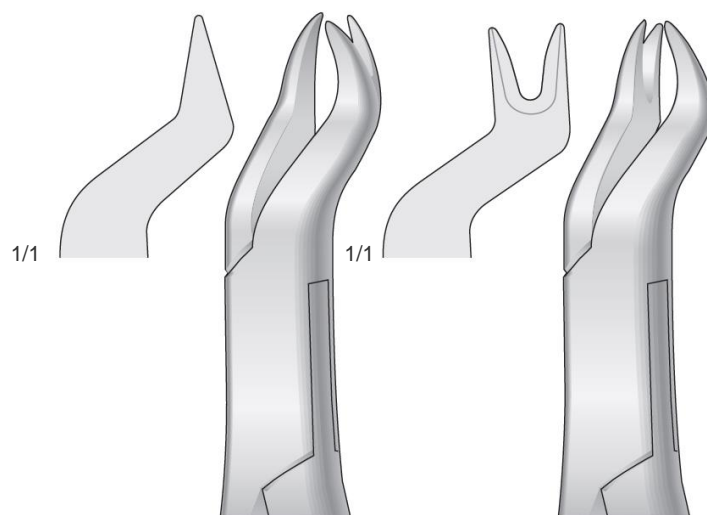


SSI-AM-53R
 Fig. 53R



SSI-AM-53L
 Fig. 53L

Obere Molaren, Links
 Upper Molars, Left
 Molari superiori, Sinistra
 Molares superiores, Izquierdos
 Molaires supérieures, Gauches



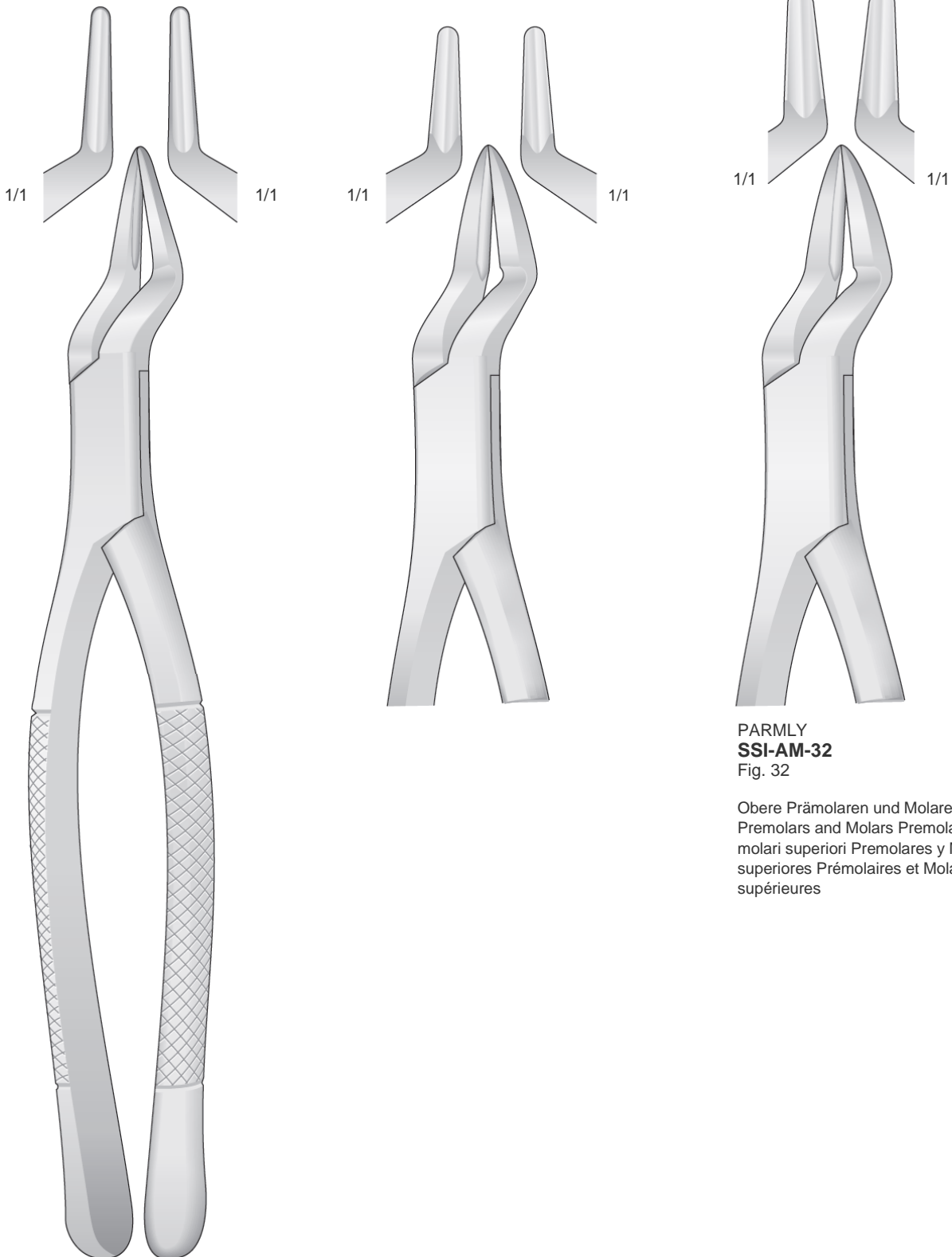
NEVIUS
SSI-AM-88R
 Fig. 88R

Obere Molaren, Rechts
 Upper Molars, Right
 Molari superiori, Destra
 Molares superiores, Derechos
 Molaires supérieures, Droites

NEVIUS
SSI-AM-88L
 Fig. 88L

Obere Molaren, Links
 Upper Molars, Left
 Molari superiori, Sinistra
 Molares superiores, Izquierdos
 Molaires supérieures, Gauches

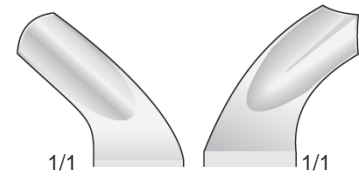
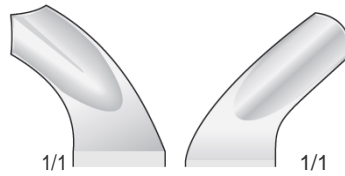
Zahnzangen, Amerikanische Form
 Extracting Forceps, American Pattern
 Pinze per estrazione, Forma Americana
 Pinzas da extracción, Forma Americana
 Daviers, Forme Américaine



PARMLY
SSI-AM-32
 Fig. 32

Obere Prämolaren und Molaren Upper
 Premolars and Molars Premolari e
 molari superiori Premolares y Molares
 superiores Prémolaires et Molaires
 supérieures

Zahnzangen, Amerikanische Form
 Extracting Forceps, American Pattern
 Pinze per estrazione, Forma Americana
 Pinzas da extracción, Forma Americana
 Daviers, Forme Américaine



HARRIS
SSI-AM-18R
 Fig. 18R

Obere Molaren, Rechts
 Upper Molars, Right
 Molari superiori, Destra
 Molares superiores, Derechos
 Molaires supérieures, Droites

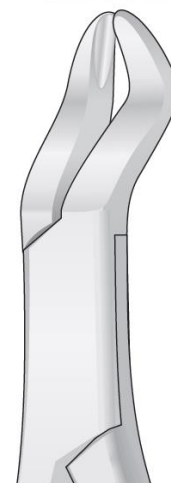
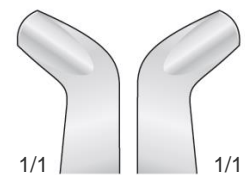
HARRIS
SSI-AM-18L
 Fig. 18L

Obere Molaren, Links Upper
 Molars, Left Molari superiori,
 Sinistra Molares superiores,
 Isquierdos Molaires
 supérieures, Gauches



SSI-AM-24
 Fig. 24

Obere Molaren
 Upper Molars
 Molari superiori
 Molares superiores
 Molaires supérieures

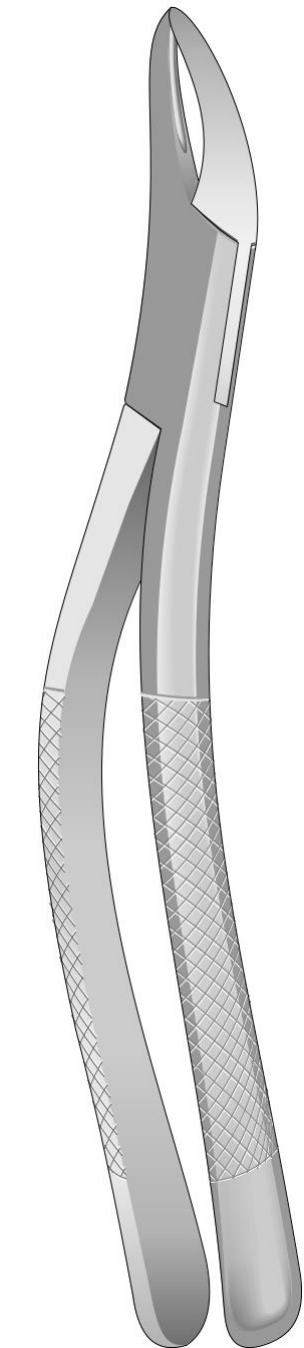
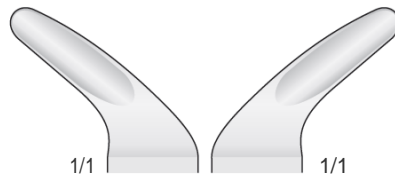
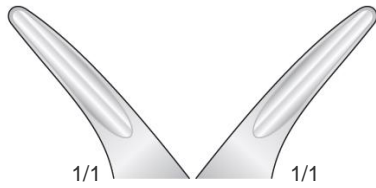


SSI-AM-210
 Fig. 210

Obere Molaren
 Upper Molars
 Molari superiori
 Molares superiores
 Molaires supérieures



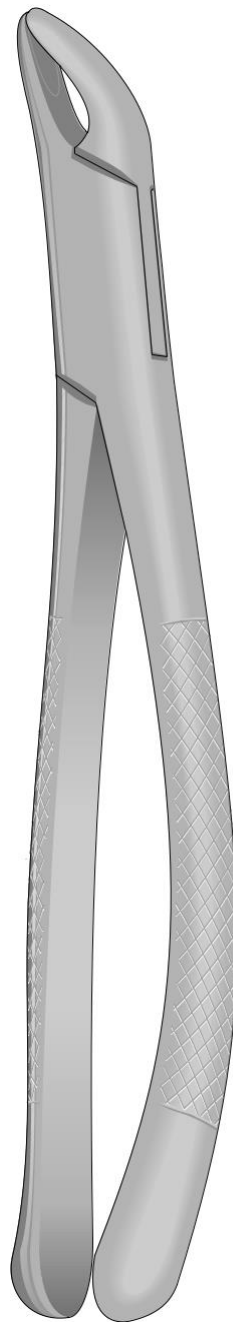
Zahnzangen, Amerikanische Form
 Extracting Forceps, American Pattern
 Pinze per estrazione, Forma Americana
 Pinzas da extracción, Forma Americana
 Daviers, Forme Américaine



Obere und Untere
 Upper and lower
 Superiori e inferiori
 Superiores y inferiores
 Supérieures et inférieures

Wurzeln
 Roots
 Radici
 Raíces
 Racines

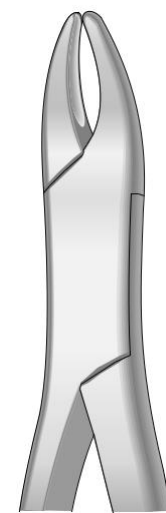
TOMES
SSI-AM-69
 Fig.69



Untere
 Lower
 Inferiori
 Inferiores
 Inférieures

Schneidezähne, Prämolaren, Wurzeln
 Incisors, Premolars, Roots
 Incisivi, premolari, radici
 Incisivos, premolares, raices
 Incisives, prémolaires, racines

CRYER
SSI-AM-1SSI-51
 Fig.1SSI-51

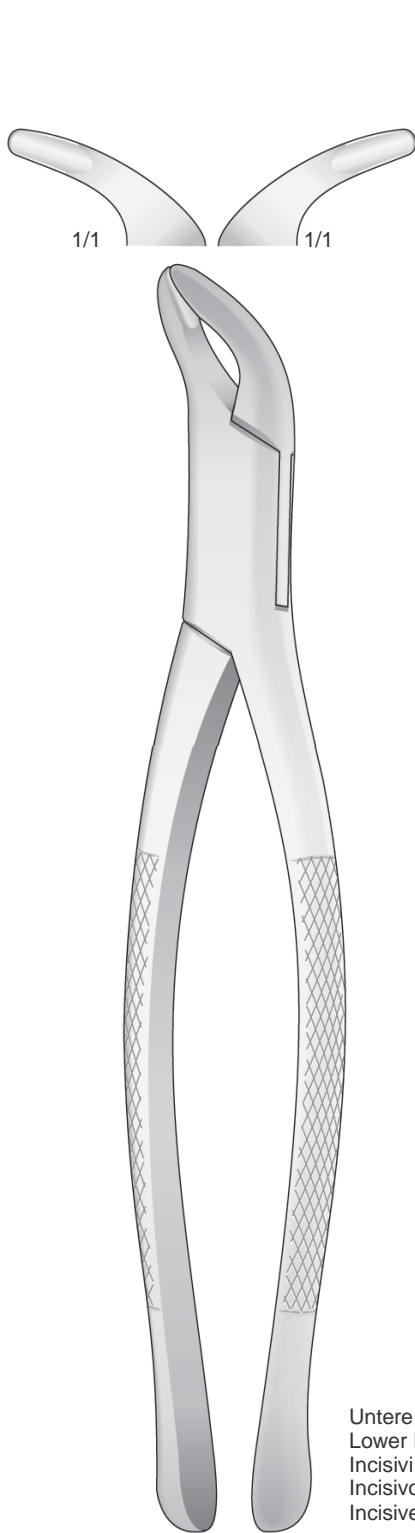


HULL
SSI-AM-101
 Fig. 101

Für Eckzähne und Prämolaren,
 Universalzange und Kinderzange
 For canines and Premolars,
 Universal and Tooth forceps for children
 Canini e premolari,
 universale e per bambini
 Caninos y premolares,
 universal y para niños
 Canines et prémolaires,
 universel et pour enfants

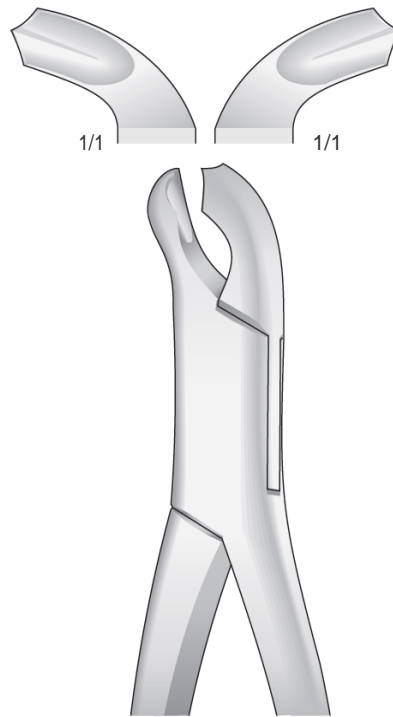
Email: sheffieldsurgicalinstruments@gmail.com
 Web: www.sheffieldsurgicalinst.com

Zahnzangen, Amerikanische Form
 Extracting Forceps, American Pattern
 Pinze per estrazione, Forma Americana
 Pinzas da extracción, Forma Americana
 Daviers, Forme Américaine



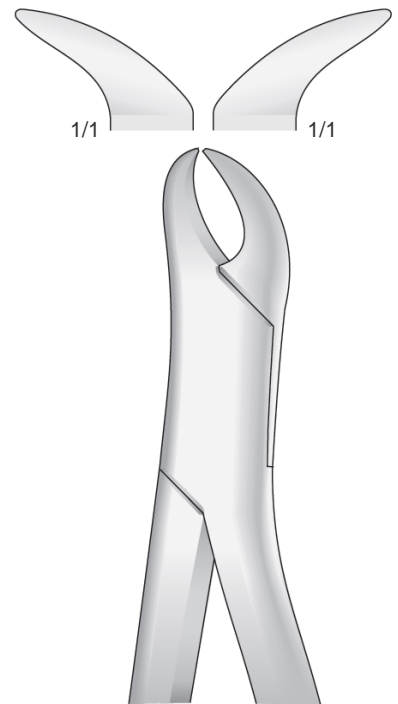
SSI-AM-203
 Fig. 203

Untere Schneidezähne, Prämolaren, Wurzeln
 Lower Incisors, Premolars, Roots
 Incisivi, premolari, radici inferiori
 Incisivos, premolares, raices inferiores
 Incisives, prémolaires, racines inférieures



SSI-AM-17
 Fig. 17

Untere Molaren
 Lower Molars
 Molari inferiori
 Molares inferiores
 Molaires inférieures

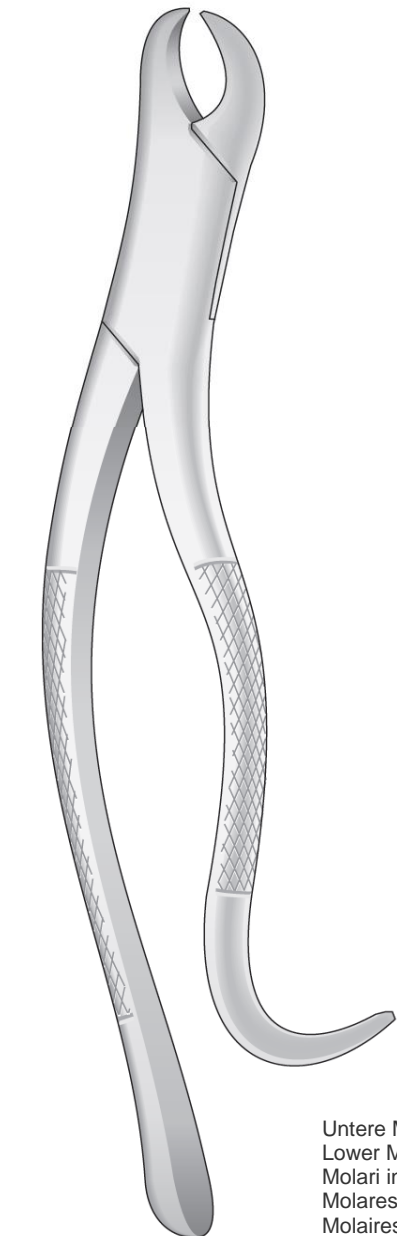
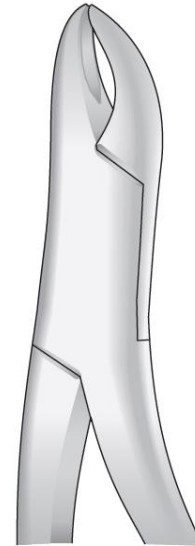
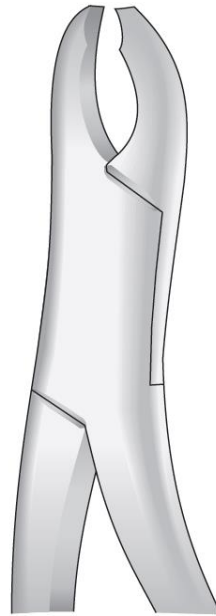
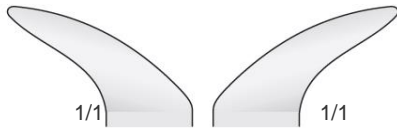
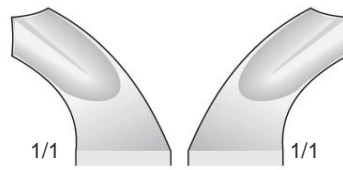


SSI-AM-23
 Fig. 23

Untere Molaren
 Lower Molars
 Molari inferiori
 Molares inferiores
 Molaires inférieures



Zahnzangen, Amerikanische Form
 Extracting Forceps, American Pattern
 Pinze per estrazione, Forma Americana
 Pinzas da extracción, Forma Americana
 Daviers, Forme Américaine



HARRIS
SSI-AM-15
 Fig. 15

SSI-AM-103
 Fig. 103

Untere Molaren
 Lower Molars
 Molari inferiori
 Molares inferiores
 Molaires inférieures

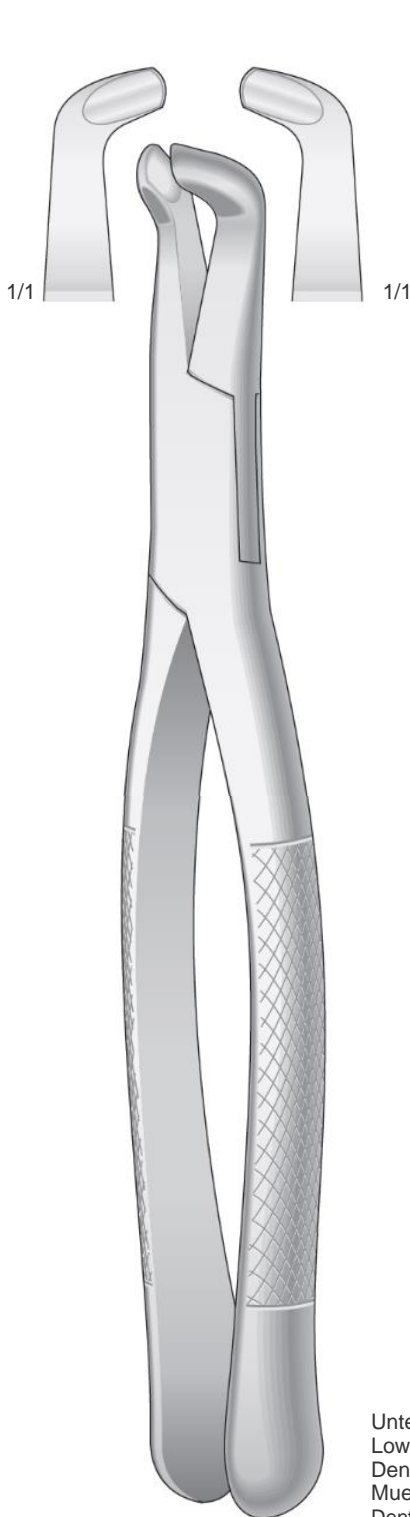
Untere Schneidezähne, Prämolaren, Wurzeln
 Lower Incisors, Premolars, Roots
 Incisivi, premolari, radici inferiori
 Incisivos, premolares, raices inferiores
 Incisives, prémolaires, racines inférieures

Untere Molaren
 Lower Molars
 Molari inferiori
 Molares inferiores
 Molaires inférieures

SSI-AM-16
 Fig. 16

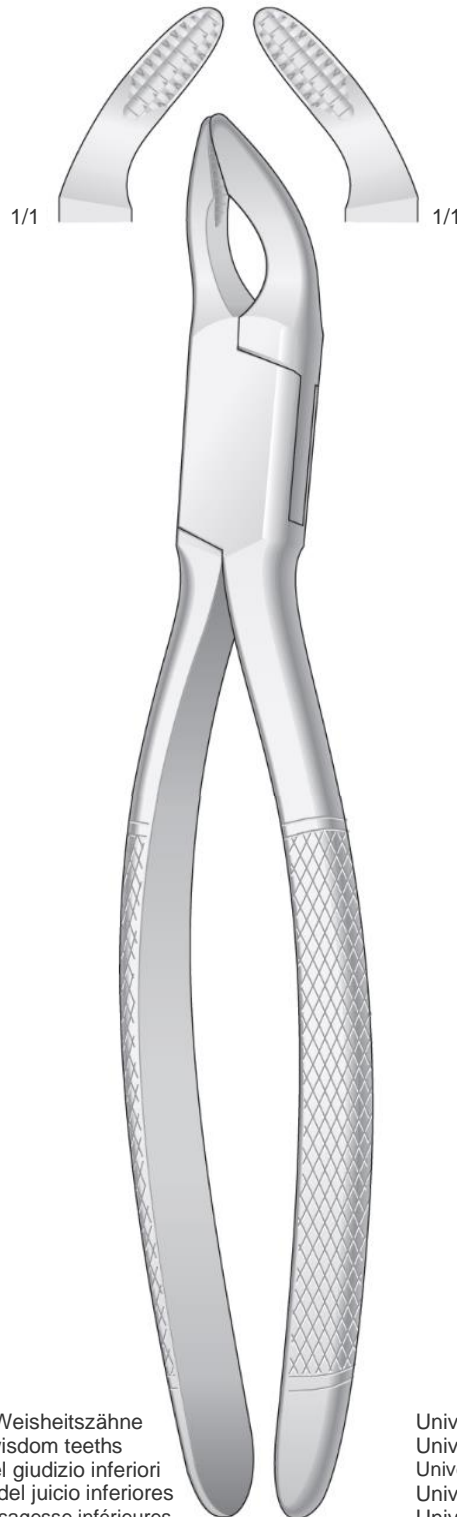
Email: sheffieldsurgicalinstruments@gmail.com
 Web: www.sheffieldsurgicalinst.com

Zahnzangen, Amerikanische Form
 Extracting Forceps, American Pattern
 Pinze per estrazione, Forma Americana
 Pinzas da extracción, Forma Americana
 Daviers, Forme Américaine



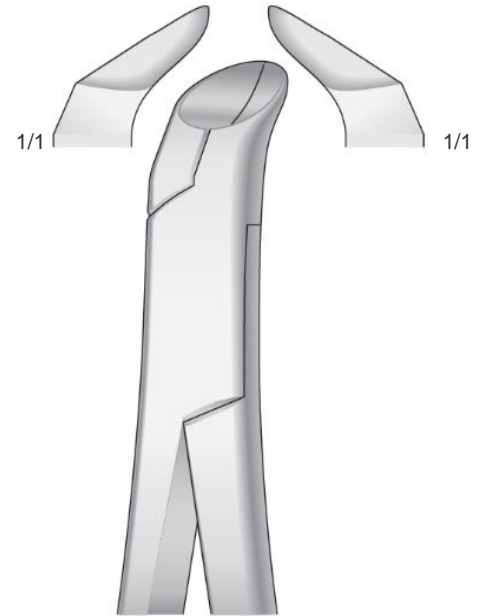
SSI-AM-222
 Fig. 222

Untere Weisheitszähne
 Lower wisdom teeth
 Denti del giudizio inferiori
 Muelas del juicio inferiores
 Dent de sagesse inférieures



COHEN
SSI-AM-250

Universal
 Universal
 Universale
 Universal
 Universel

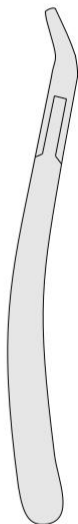
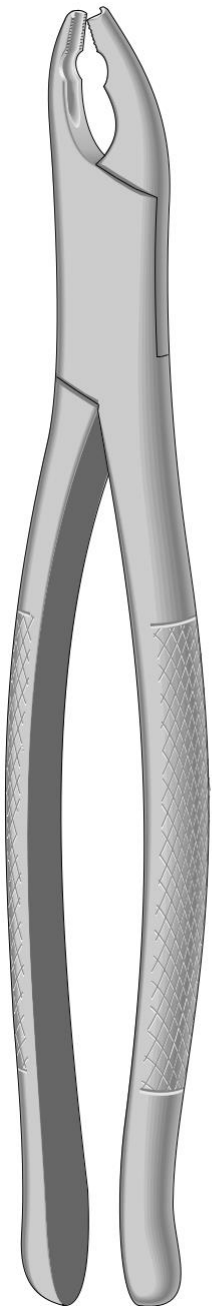
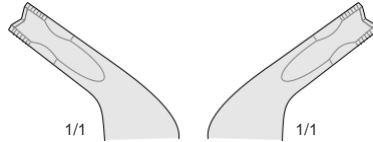
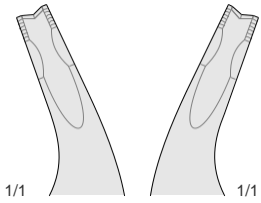


PHYSICK
SSI-AM-5
 Fig. 5

Untere Weisheitszähne
 Lower wisdom teeth
 Denti del giudizio inferiori
 Muelas del juicio inferiores
 Dent de sagesse inférieures



Zahnzangen, Amerikanische Form
Extracting Forceps, American Pattern
Pinze per estrazione, Forma Americana
Pinzas da extracción, Forma Americana
Daviers, Forme Américaine



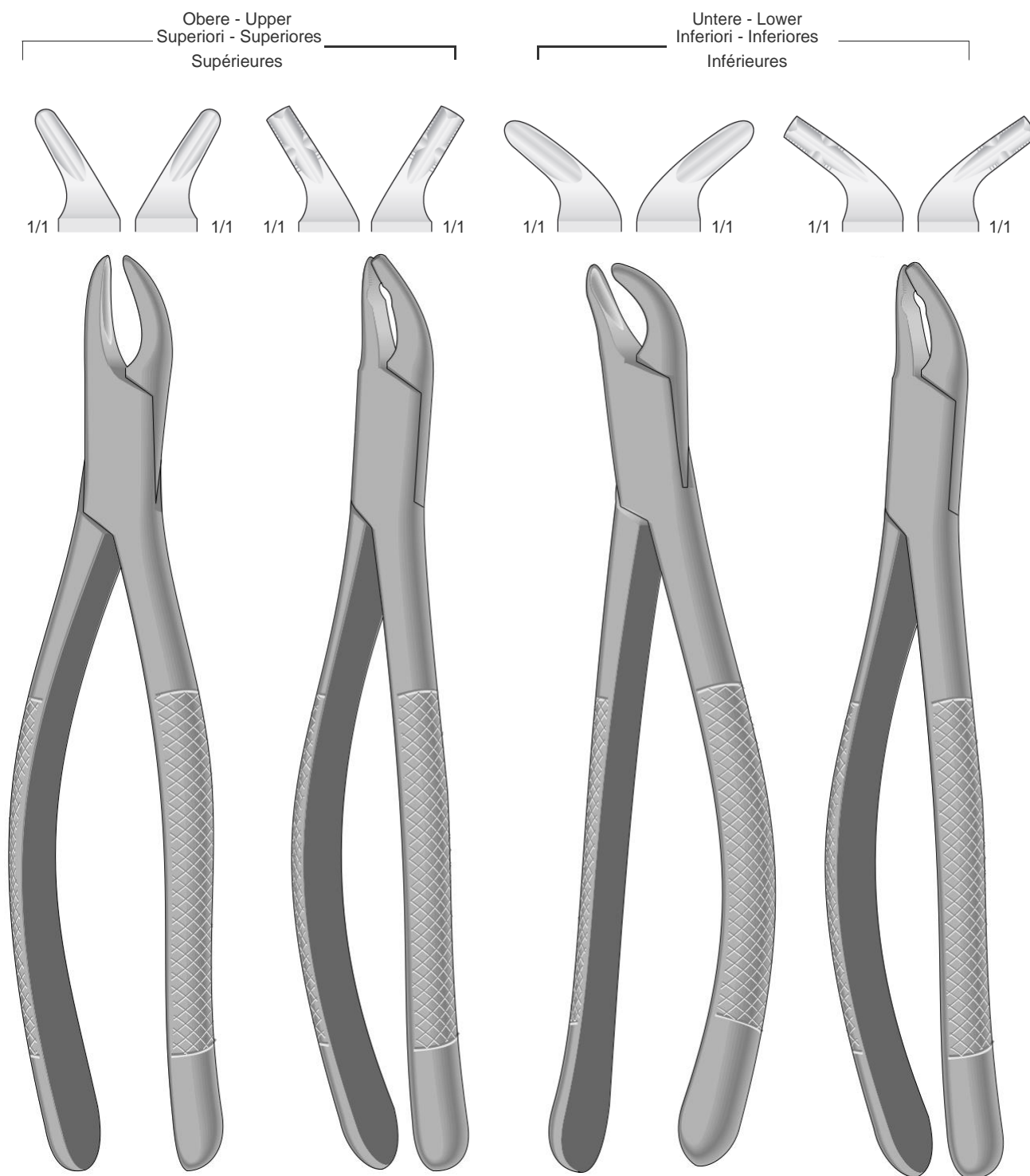
Untere
Lower
Inferiori
Inferiores
Inférieures

Prämolaren, Schneidezähne und
Wurzeln Bicuspids, incisors and roots
Premolari, incisivi e radici Premolares,
incisivos y raices Premolaires, incisives
et racines

Email: sheffieldsurgicalinstruments@gmail.com
Web: www.sheffieldsurgicalinst.com

Zahnzangen, Amerikanische Form
 Extracting Forceps, American Pattern
 Pinze per estrazione, Forma Americana
 Pinzas da extracción, Forma Americana
 Daviers, Forme Américaine

Für Kinder
 For children
 Per bambini
 Para niños
 Pour enfants



CRYER
SSI-AM-150S
 Fig.150 S

SSI-AM-150AS
 Fig.150 XAS

CRYER
SSI-AM-151S
 Fig.151 S

SSI-AM-151AS
 Fig.151 XAS

Email: sheffieldsurgicalinstruments@gmail.com
 Web: www.sheffieldsurgicalinst.com

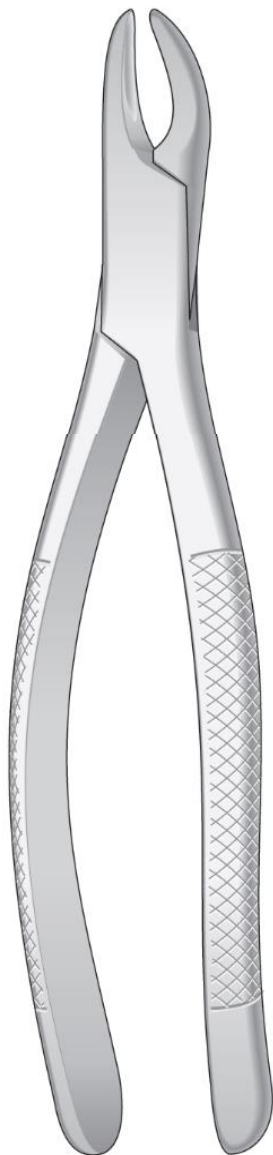
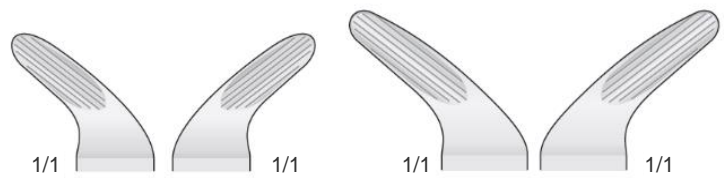
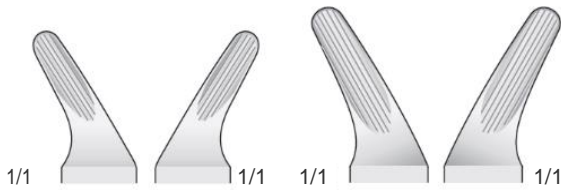


Zahnzangen, Amerikanische Form
 Extracting Forceps, American Pattern
 Pinze per estrazione, Forma Americana
 Pinzas da extracción, Forma Americana
 Daviers, Forme Américaine

Geriefte - Serrated - Striata - Estriadas - Striées

Obere Schneidezähne, Prämolaren, Wurzeln
 Upper incisors, premolars, roots
 Incisivi, premolari e radici superiori
 Incisivos, premolares y raices superiores
 Incisives, premoiaires et racines supérieures

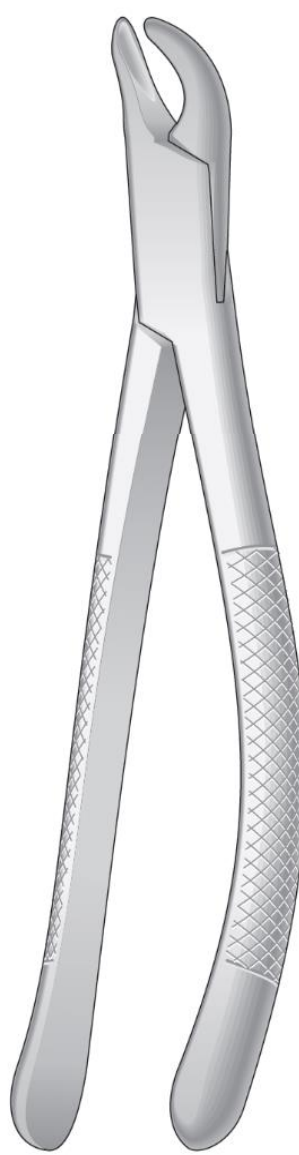
Untere Schneidezähne, Prämolaren, Wurzeln
 Lower incisors, premolars, roots
 Incisivi, premolari e radici inferiori
 Incisivos, premolares y raices inferiores
 Incisives, premoiaires et racines inférieures



CRYER
SSI-AMG-150
 Fig. 150
 Für Erwachsene
 For adults
 Per adulti
 Para adultos
 Pour adults

Für Kinder
 For children
 Per bambini
 Para niños
 Pour enfants

CRYER
SSI-AMG-150S
 Fig.150 S



CRYER
SSI-AMG-1SSI-51
 Fig. 1SSI-51
 Für Erwachsene
 For adults
 Per adulti
 Para adultos
 Pour adults

Für Kinder
 For children
 Per bambini
 Para niños
 Pour enfants

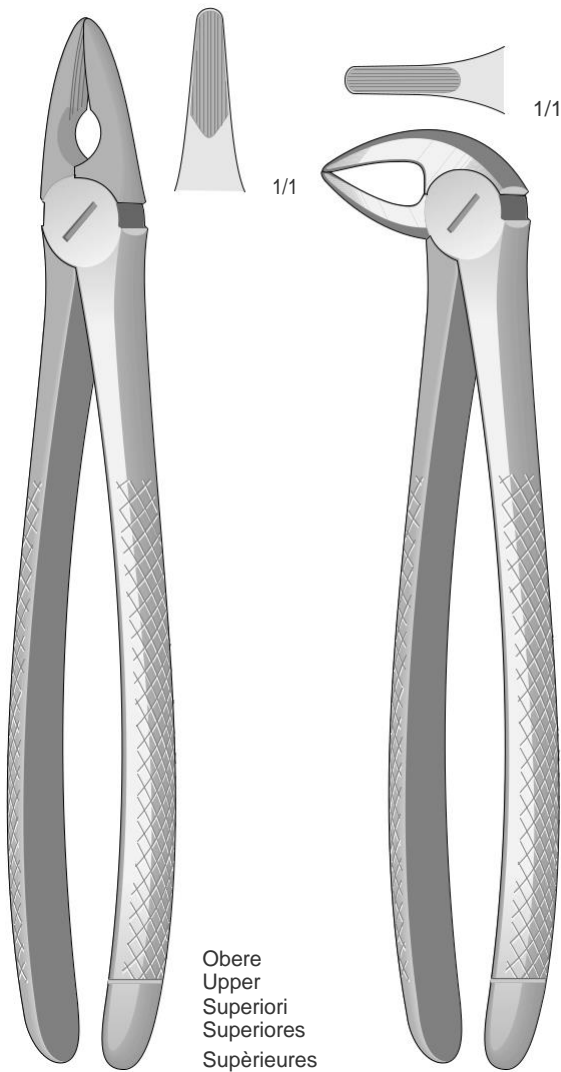
CRYER
SSI-AMG-151S
 Fig.151 S

Email: sheffieldsurgicalinstruments@gmail.com
 Web: www.sheffieldsurgicalinst.com

Zahnzangen
 Extracting Forceps
 Pinze per estrazione
 Pinzas da extracción
 Daviers

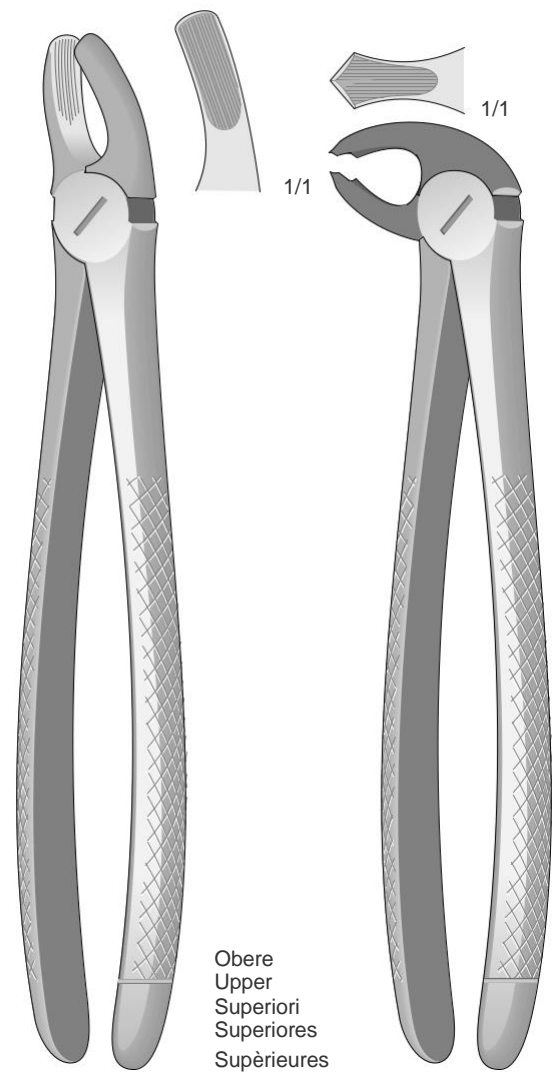
Schneidezähne, Eckzähne, Wurzeln
 Incisors, bicuspid and roots
 Incisivi, canini e radici
 Incisivos, caninos y raíces
 Incisives, canines et racines

Molaren
 Molars
 Molari
 Molares
 Molaies



Obere
 Upper
 Superiori
 Superiores
 Supérieures

Untere
 Lower
 Inferiori
 Inferiores
 Inférieures



Obere
 Upper
 Superiori
 Superiores
 Supérieures

Untere
 Lower
 Inferiori
 Inferiores
 Inférieures

MEAD
 SSI-MD-1

MEAD
 SSI-MD-3

MEAD
 SSI-MD-2

MEAD
 SSI-MD-4

Email: sheffieldsurgicalinstruments@gmail.com
 Web: www.sheffieldsurgicalinst.com



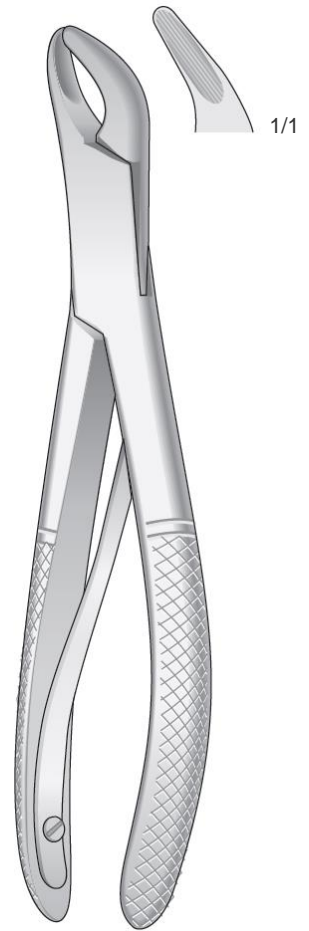
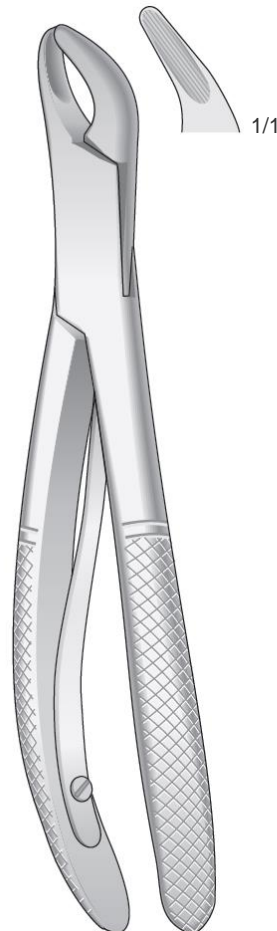
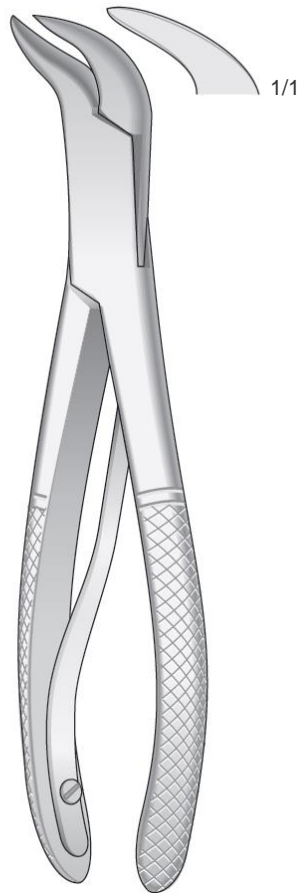
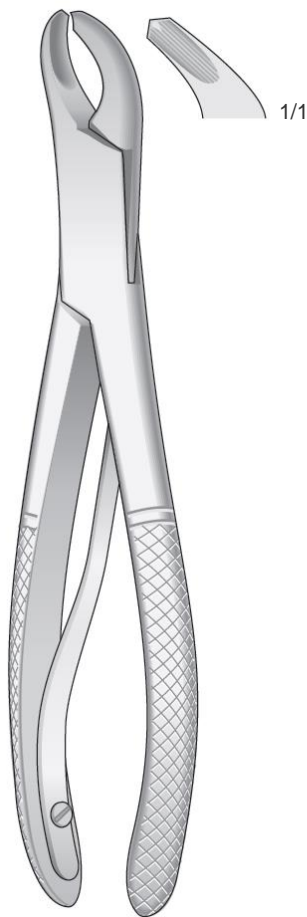
Kinderzahnzangen, Amerikanische Form
Extracting Forceps for children, American Pattern
Pinze per estrazione per bambini, Forma Americana
Forceps dentales para niños, Forma Americana
Daviers pour enfants, Forme Américaine

Molaren
Pedo Lower Molars
Molari
Molares
Molaires

Molaren
Pedo Lower Molars
Molari
Molares
Molaires

Zähne und wurzeln
Pedo upper incisors
Bicuspids and roots
Denti e radici
Dientes y raíces
Dentes et racines

Zähne und wurzeln
Pedo lower incisors
Bicuspids and roots
Denti e radici
Dientes y raíces
Dentes et racines



SSI-PEB-17S
Fig. 17SK

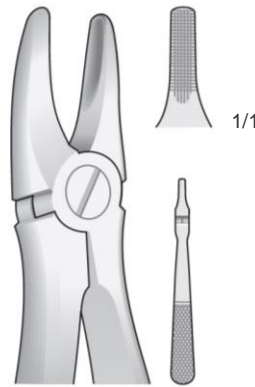
SSI-PEB-23S
Fig. 23SK

SSI-PEB-150S
Fig. 150SK

SSI-PEB-151S
Fig. 151SK

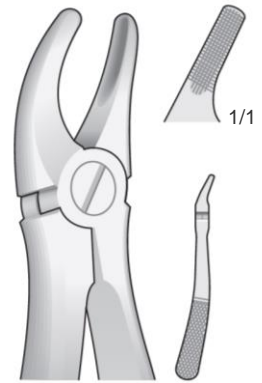
Email: sheffieldsurgicalinstruments@gmail.com
Web: www.sheffieldsurgicalinst.com

Kinderzahnzangen
 Extracting Forceps for children
 Pinze per estrazione per bambini
 Forceps dentales para niños
 Daviers pour enfants



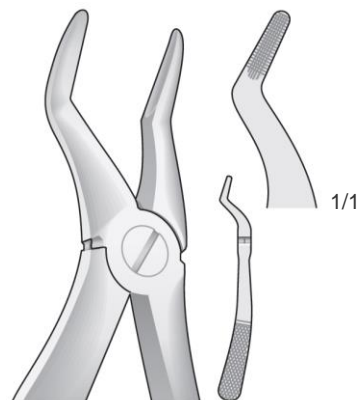
SSI-PEB-1
 Fig. 137

Obere Schneidezähne
 Upper Incisors
 Incisivi superiori
 Incisivos superiores
 Incisives supérieures



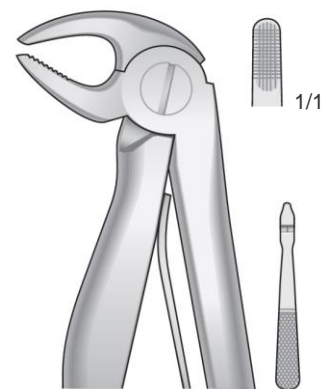
SSI-PEB-2
 Fig. 139

Obere Prämolaren
 Upper Premolars
 Premolari superiori
 Premolares superiores
 Prémolaires supérieures



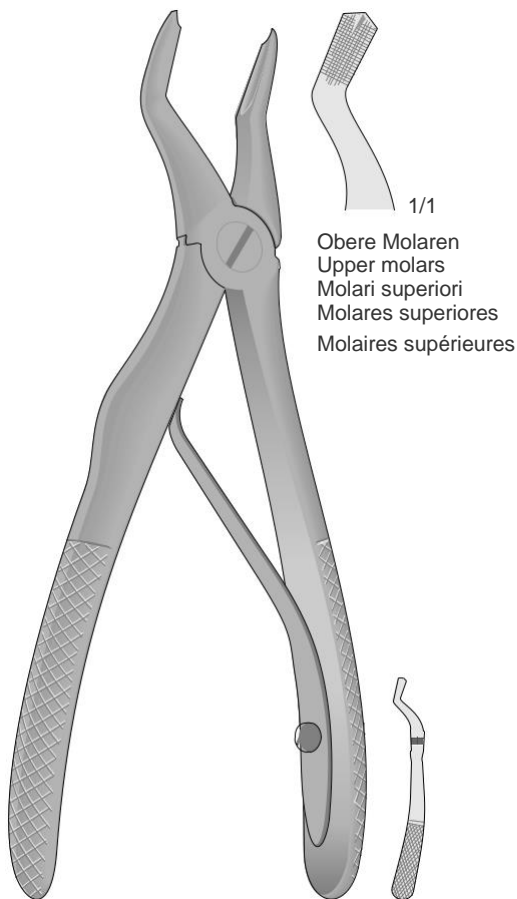
SSI-PEB-4
 Fig. 51S

Obere Wurzeln
 Upper roots
 Radici superiori
 Raíces superiores
 Racines supérieures

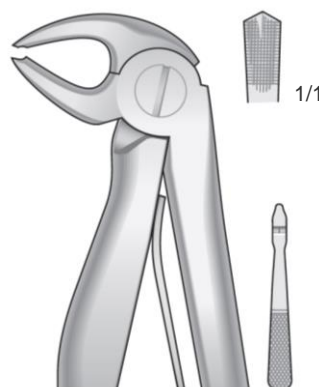


SSI-PEB-5
 Fig. 5

Untere Schneidezähne
 Lower incisors
 Incisivi inferiori
 Incisivos inferiores
 Incisives inférieures

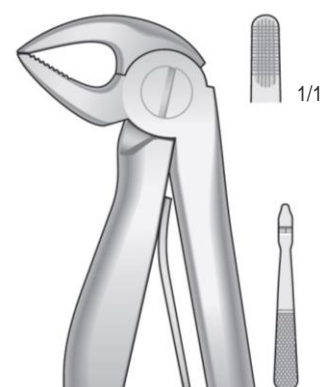


SSI-PEB-3



SSI-PEB-6
 Fig. 6

Untere Molaren
 Lower Molars
 Molari inferiori
 Molares inferiores
 Molaires inférieures

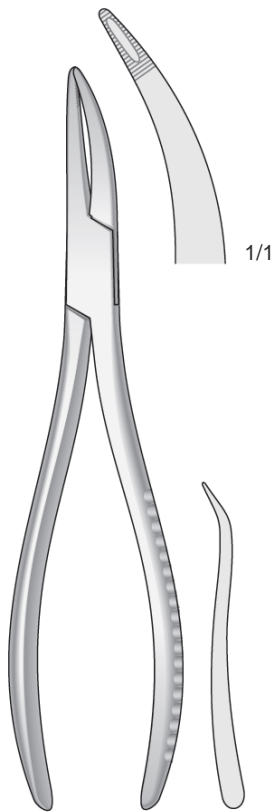


SSI-PEB-7
 Fig. 7

Untere Wurzeln
 Lower roots
 Radici inferiori
 Raíces inferiores
 Racines inférieures



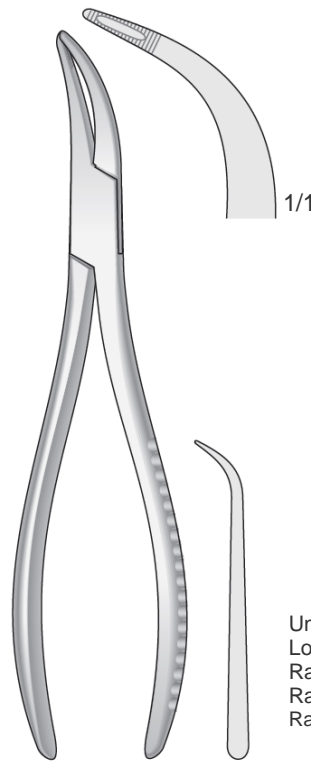
Zahnzangen
Extracting Forceps
Pinze per estrazione
Pinzas da extracción
Daviers



1/1

Obere Wurzeln, Universal
Upper roots, Universal
Radici superiori, Universale
Raices superiores, Universal
Racines superieures, Universel

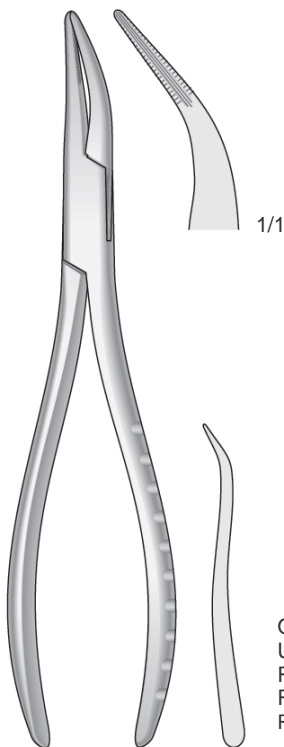
**WITZEL
SSI-DK-26**
170 mm



1/1

Untere Wurzeln, Universal
Lower roots, Universal
Radici inferiori, Universale
Raices inferiores, Universal
Racines inferieures, Universel

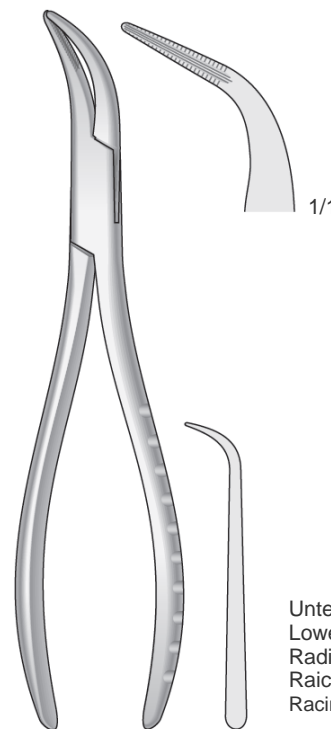
**WITZEL
SSI-DK-28**
165 mm



1/1

Obere Wurzeln, Universal
Upper roots, Universal
Radici superiori, Universale
Raices superiores, Universal
Racines superieures, Universel

SSI-400 (300)
165 mm



1/1

Untere Wurzeln, Universal
Lower roots, Universal
Radici inferiori, Universale
Raices inferiores, Universal
Racines inferieures, Universel

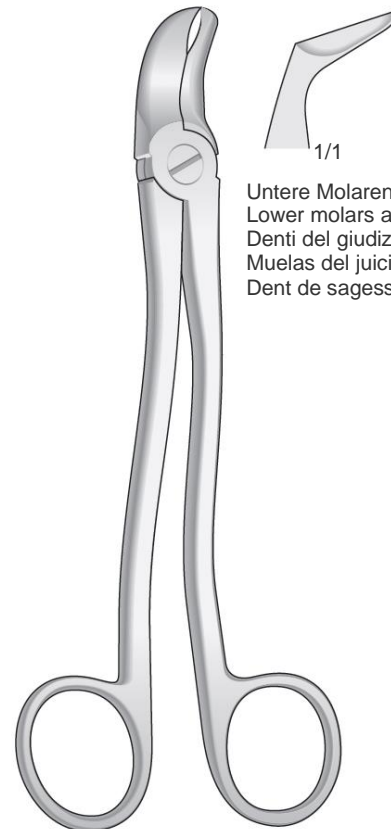
SSI-401 (301)
160 mm

Email: sheffieldsurgicalinstruments@gmail.com
Web: www.sheffieldsurgicalinst.com

Wurzelfragmentinstrumente
 Root Fragment Forceps
 Strumenti per frammenti di radici
 Instrumentos para fragmentos de raíces
 Instruments pour fragments de racines



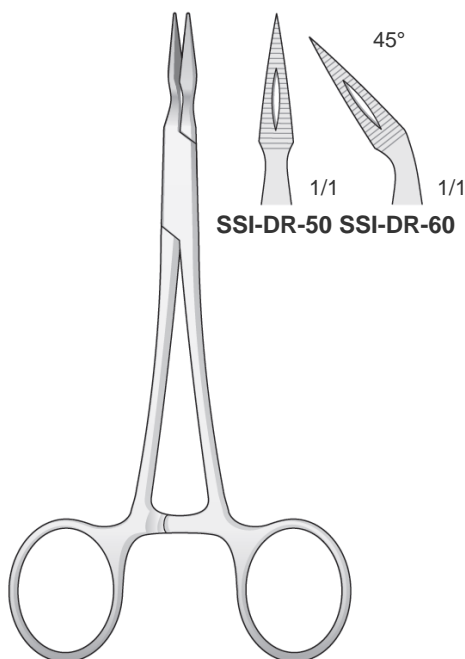
PEET
SSI-DR-40
 120 mm



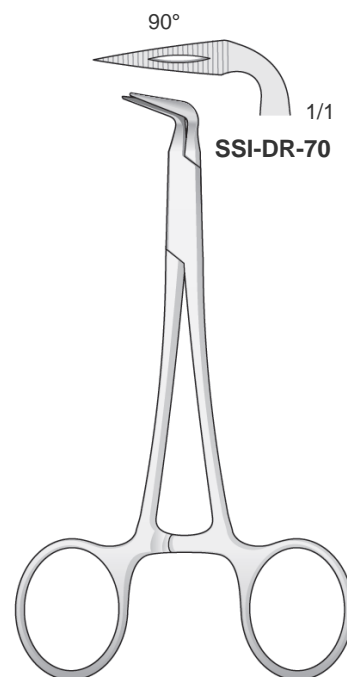
Untere Molaren und Weisheitszähne
 Lower molars and wisdom teeth
 Denti del giudizio e molari inferiori
 Muelas del juicio y molares inferiores
 Dent de sagesse et molaires inférieures

SSI-RO-1
 175 mm

Wurzelfragmente
 Root fragments
 Frammenti di radici
 Fragmentos de raíces
 Fragments de racines



STIEGLITZ
SSI-DR-50/SSI-DR-60
 140 mm

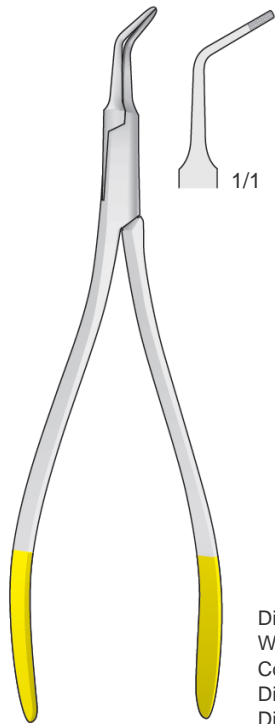


STIEGLITZ
SSI-DR-70
 120 mm

Email: sheffieldsurgicalinstruments@gmail.com
 Web: www.sheffieldsurgicalinst.com

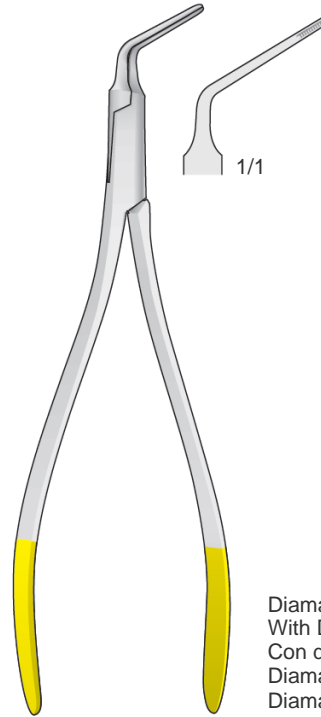


Wurzelfragmentinstrumente
Root Fragment Forceps
Strumenti per frammenti di radici
Instrumentos para fragmentos de raíces
Instruments pour fragments de racines



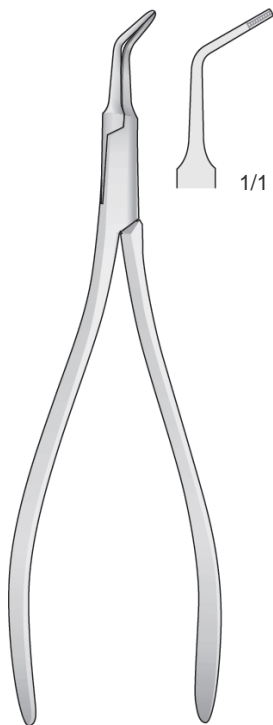
Diamantiert
With Diamond
Con diamante
Diamantada
Diamantées

SSI-DA-01M
130 mm

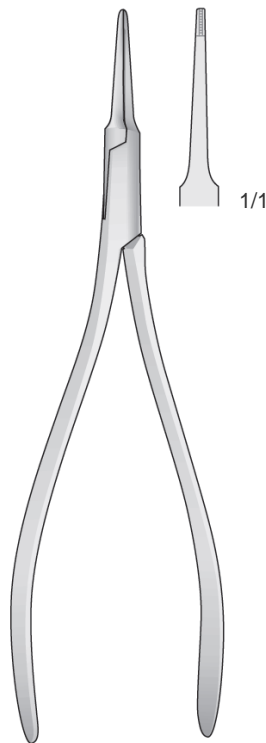


Diamantiert
With Diamond
Con diamante
Diamantada
Diamantées

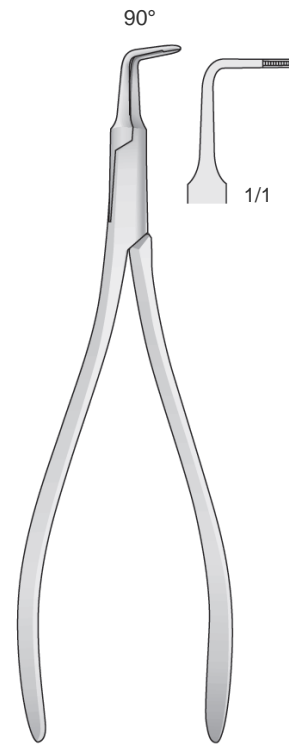
SSI-DA-10
130 mm



SSI-DA-01
130 mm



SSI-DA-02
130 mm



SSI-DA-03
125 mm

Email: sheffieldsurgicalinstruments@gmail.com
Web: www.sheffieldsurgicalinst.com

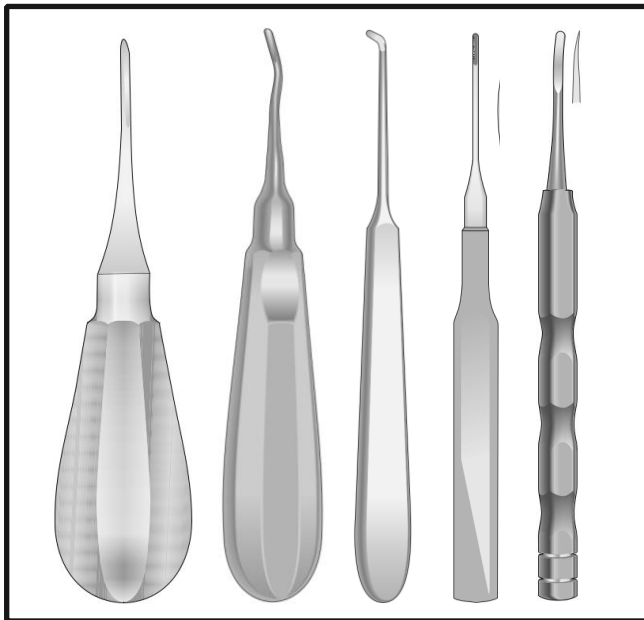
Root Elevators

Wurzelheber

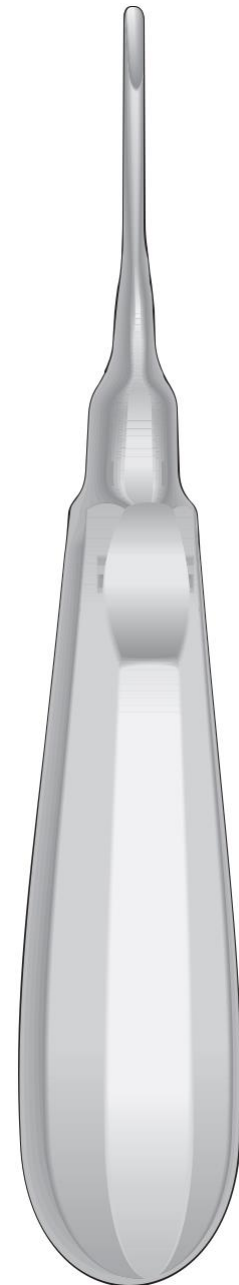
Elevatori per radici

Elevadores para raíces

Elévateurs pour racines



Sheffield Surgical is highly experienced Manufacturer & exporter of high quality Dental Instruments and also in the field of General Surgery, Bone Surgery an Orthopedic Instruments.

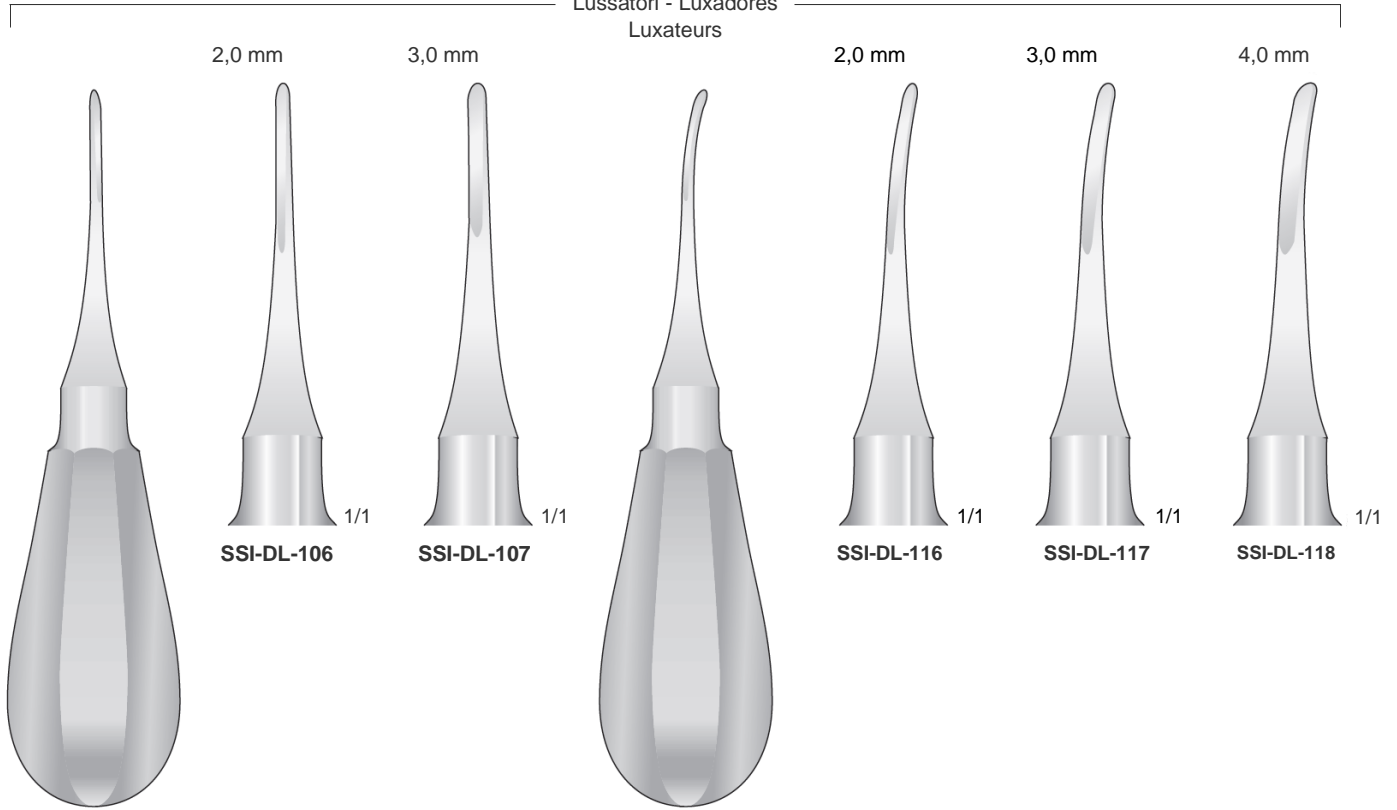




Wurzelheber
 Root Elevators
 Leve per radici
 Elevadores para raíces
 Elevateurs à racines

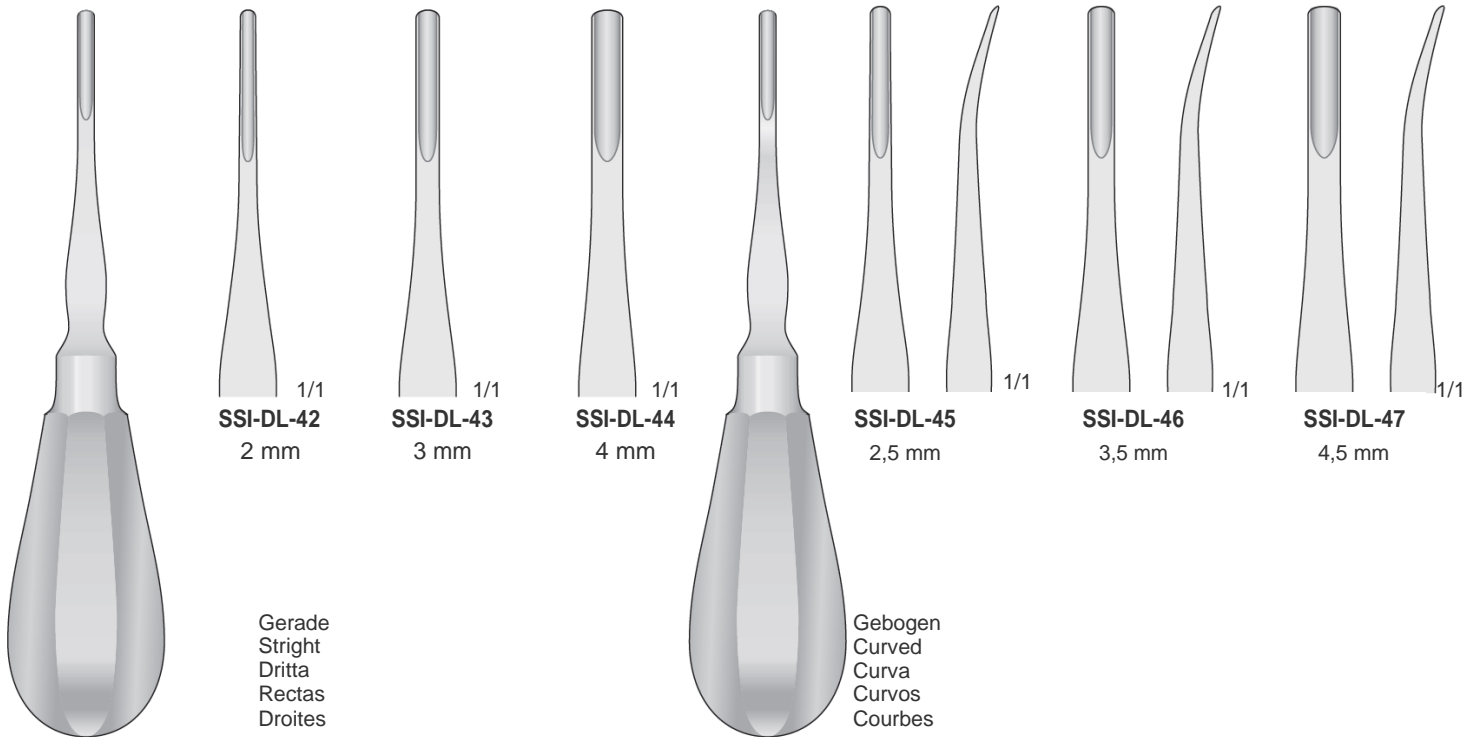
SMALL HANDLE

Luxatoren - Luxators
 Lussatori - Luxadores
 Luxateurs



SSI-DL-106/SSI-DL-107
120 mm

SSI-DL-116/SSI-DL-118
120 mm



Gerade
 Stright
 Dritta
 Rectas
 Droites

Gebogen
 Curved
 Curva
 Curvos
 Courbes

BEIN
SSI-DL-42/SSI-DL-44

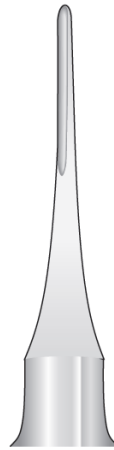
SSI-DL-45/SSI-DL-47

Email: sheffieldsurgicalinstruments@gmail.com
 Web: www.sheffieldsurgicalinst.com



Wurzelheber Root
Elevators Leve per
radici Elevadores
para raíces
Elevateurs à racines

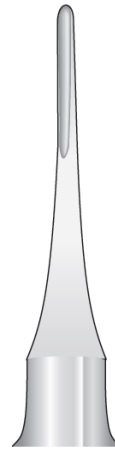
2,0 mm



1/1

SSI-DL-81
150 mm

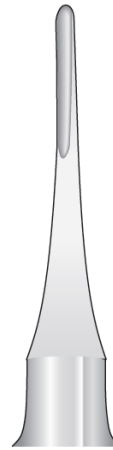
2,5 mm



1/1

SSI-DL-82
150 mm

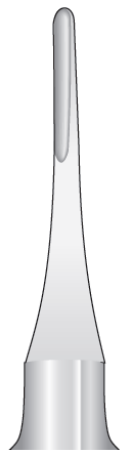
3,0 mm



1/1

SSI-DL-83
150 mm

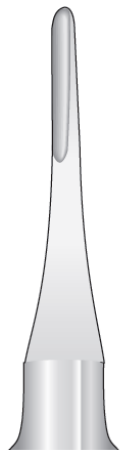
3,5 mm



1/1

SSI-DL-84
150 mm

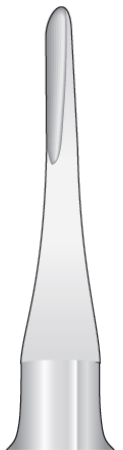
4,0 mm



1/1

SSI-DL-85
150 mm

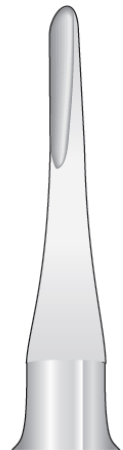
4,5 mm



1/1

SSI-DL-86
150 mm

5,0 mm



1/1

SSI-DL-87
150 mm

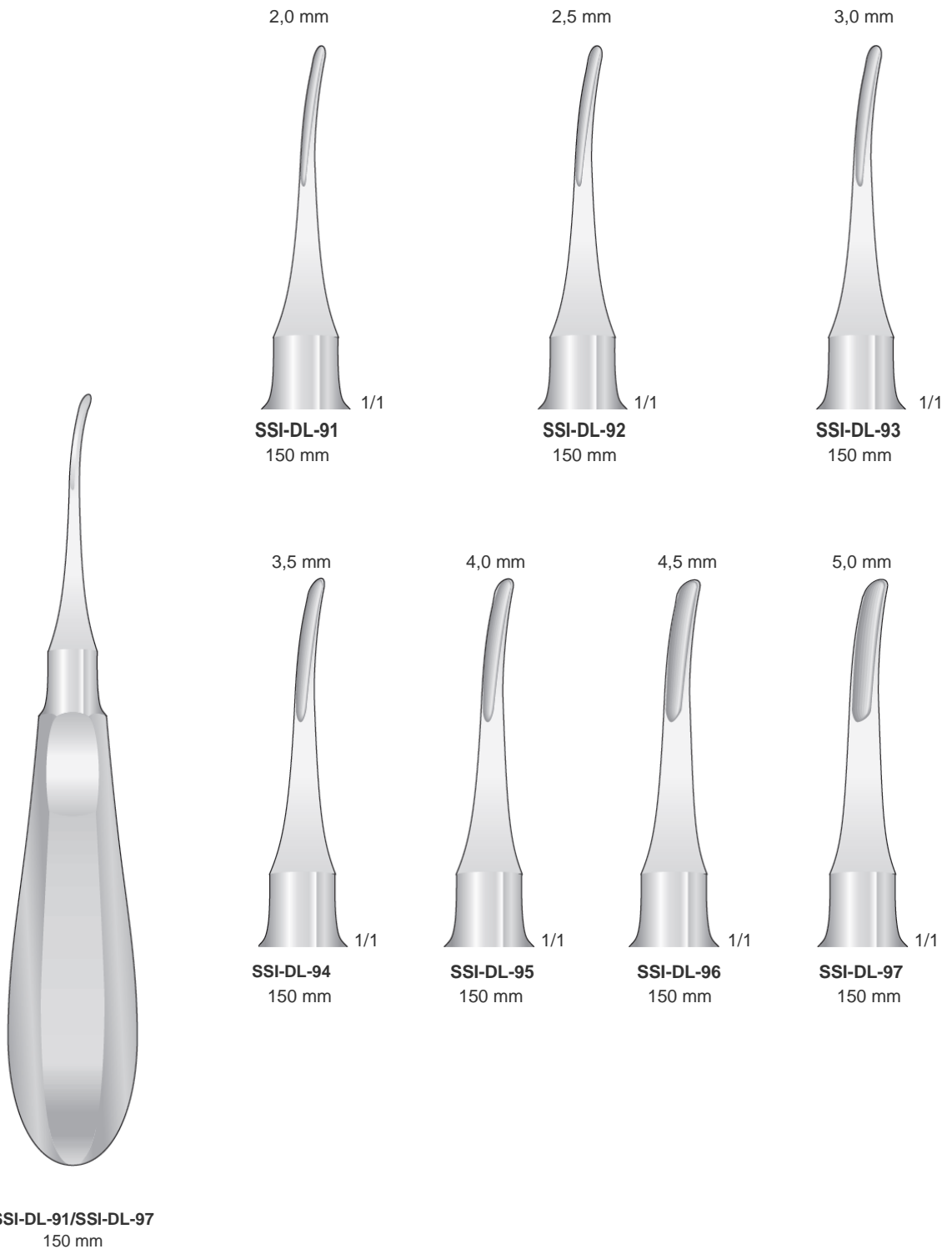


SSI-DL-81/SSI-DL-87
150 mm

Email: sheffieldsurgicalinstruments@gmail.com
Web: www.sheffieldsurgicalinst.com



Wurzelheber Root
Elevators Leve per
radici Elevadores
para raíces
Elevateurs à racines

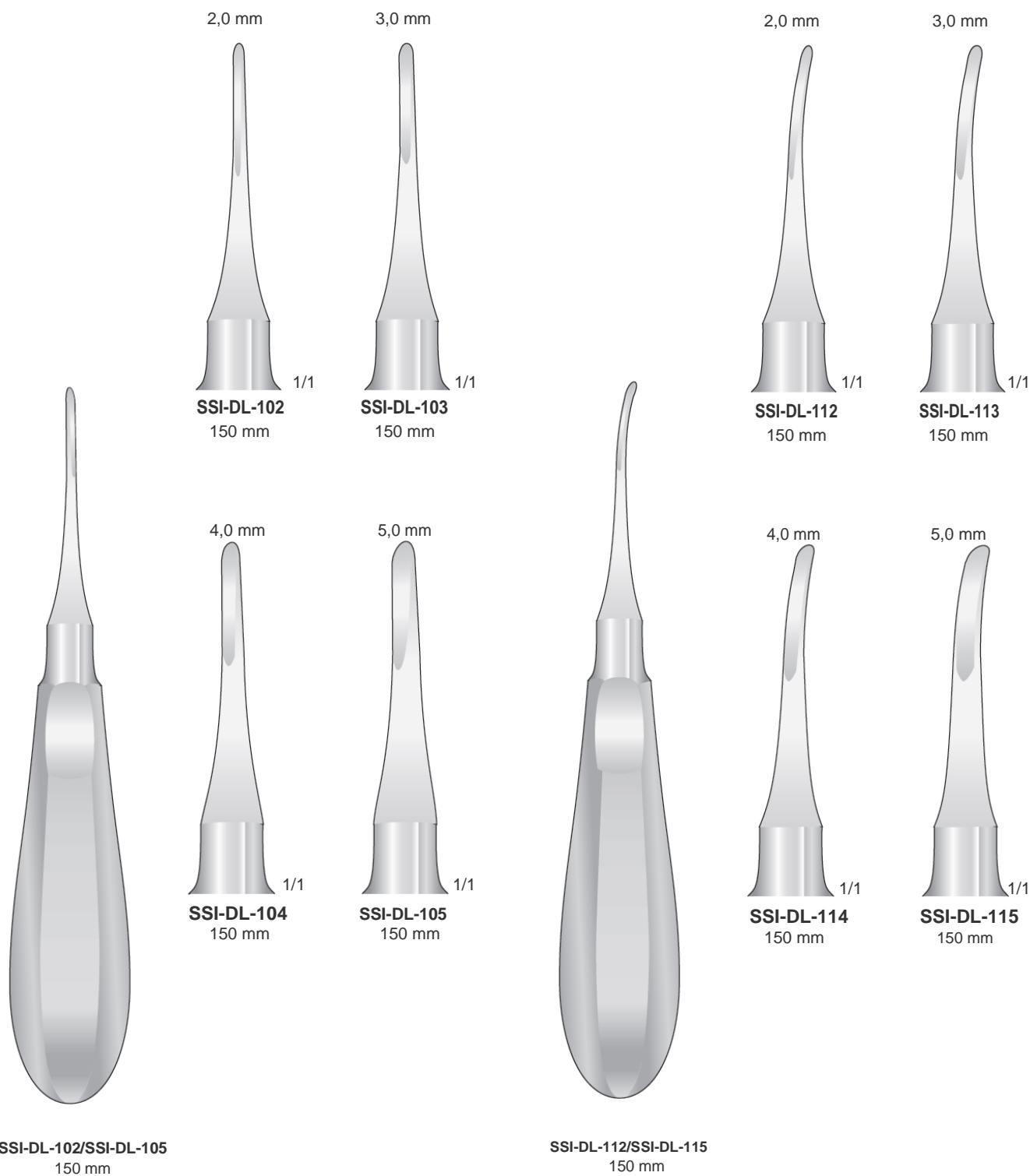


Email: sheffieldsurgicalinstruments@gmail.com
Web: www.sheffieldsurgicalinst.com



Wurzelheber Root
Elevators Leve per
radici Elevadores
para raíces
Elevateurs à racines

Luxatoren
Luxators
Lussatori
Luxadores
Luxateurs

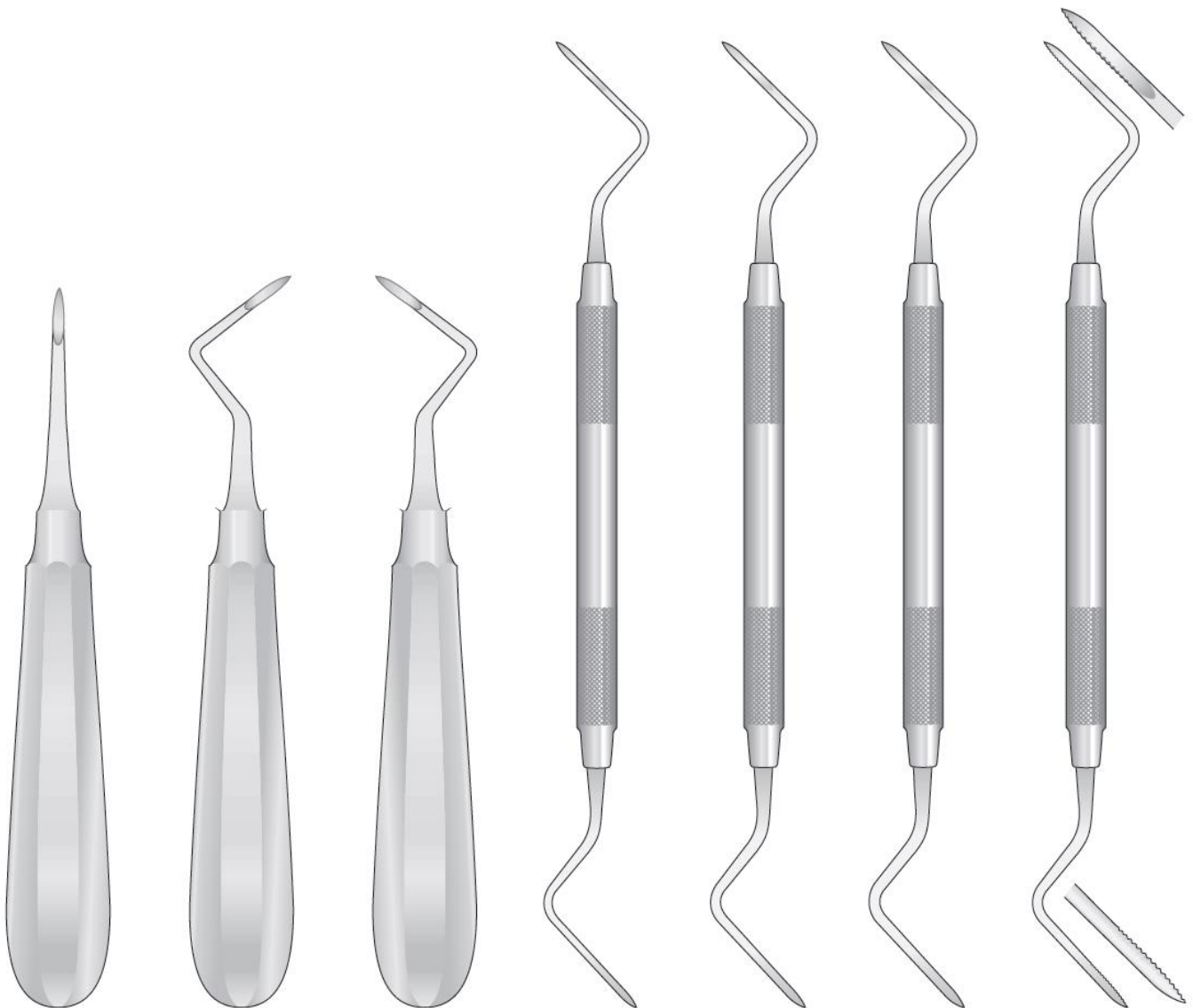


Email: sheffieldsurgicalinstruments@gmail.com
Web: www.sheffieldsurgicalinst.com

Wurzelheber Root
Elevators Leve per
radici Elevadores
para raíces
Elevateurs à racines

Wurzelspitzenheber
Root fragment Elevators
Leve per frammenti di radice
Elevadores para fragmentos de raíces
Elévateurs de fragments de racines

Gezahnt
Serrated
Dentellata
Dentada
Dentelé



HEIDBRINK
SSI-HE-1
140 mm

HEIDBRINK
SSI-HE-2
140 mm

HEIDBRINK
SSI-HE-3
140 mm

HEIDBRINK
SSI-725-1/2
195 mm

HEIDBRINK
SSI-725-3/4
195 mm

HEIDBRINK
SSI-725-5/6
195 mm

HEIDBRINK
SSI-725-3/4S
195 mm

Email: sheffieldsurgicalinstruments@gmail.com
Web: www.sheffieldsurgicalinst.com



Wurzelheber Root
Elevators Leve per
radici Elevadores
para raíces
Elevateurs à racines

Extraktionshebel für obere Weisheitszähne
Luxator for upper wisdom teeth
Leva per estrazione dente del giudizio superiore
Elevador de extracción de muelas del juicio superiores
Levier d'extraction pour dent de sagesse supérieures

Wurzelheber
Root Elevators
Leve per radici
Elevadores para raíces
Elévateurs de racines



ROSIN
SSI-DL-58
160 mm



WARWICK-JAMES
SSI-DL-20
160 mm



WARWICK-JAMES
SSI-DL-21
155 mm



WARWICK-JAMES
SSI-DL-22
155 mm

Obere
Upper
Superiori
Superiores
Supérieures

Untere
Lower
Inferiori
Inferiores
Inférieures

Untere
Lower
Inferiori
Inferiores
Inférieures

Email: sheffieldsurgicalinstruments@gmail.com
Web: www.sheffieldsurgicalinst.com

Wurzelheber Root
Elevators Leve per
radici Elevadores
para raíces
Elevateurs à racines

Eine seite gezahnt
One side serrated
Un lato dentellato
Dentadura mäs lado
Dentelure sur un côté



Fig. 94



SSI-DL-76
155 mm

Fig. 95



SSI-DL-77
155 mm

Fig. 100L



SSI-DL-78
155 mm

Fig. 100R



SSI-DL-79
155 mm

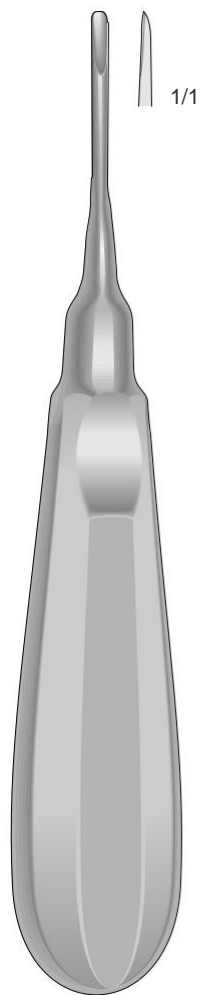


Wurzelheber Root
Elevators Leve per
radici Elevadores
para raíces
Elevateurs à racines

Gezant
Serrated
Dentellate
Dentadas
Dentelé

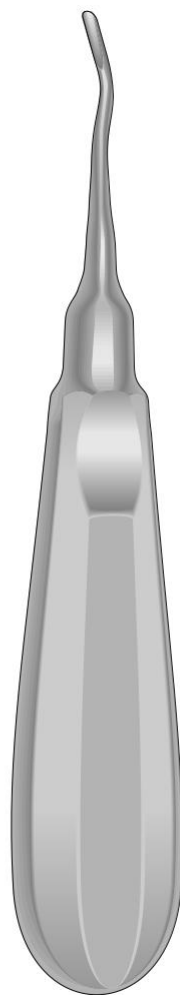


Fig. 301



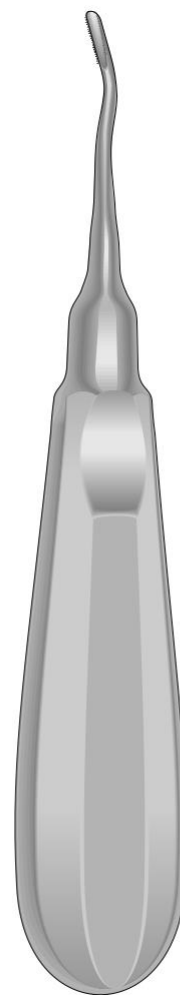
APEXO
SSI-DL-34
160 mm

Fig. 302



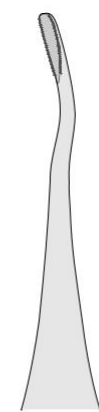
APEXO
SSI-DL-35/SSI-DL-36
160 mm

Fig. 303



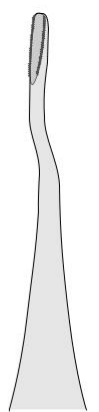
APEXO
SSI-DL-37/SSI-DL-38
160 mm

Fig. 77L



SSI-DL-37

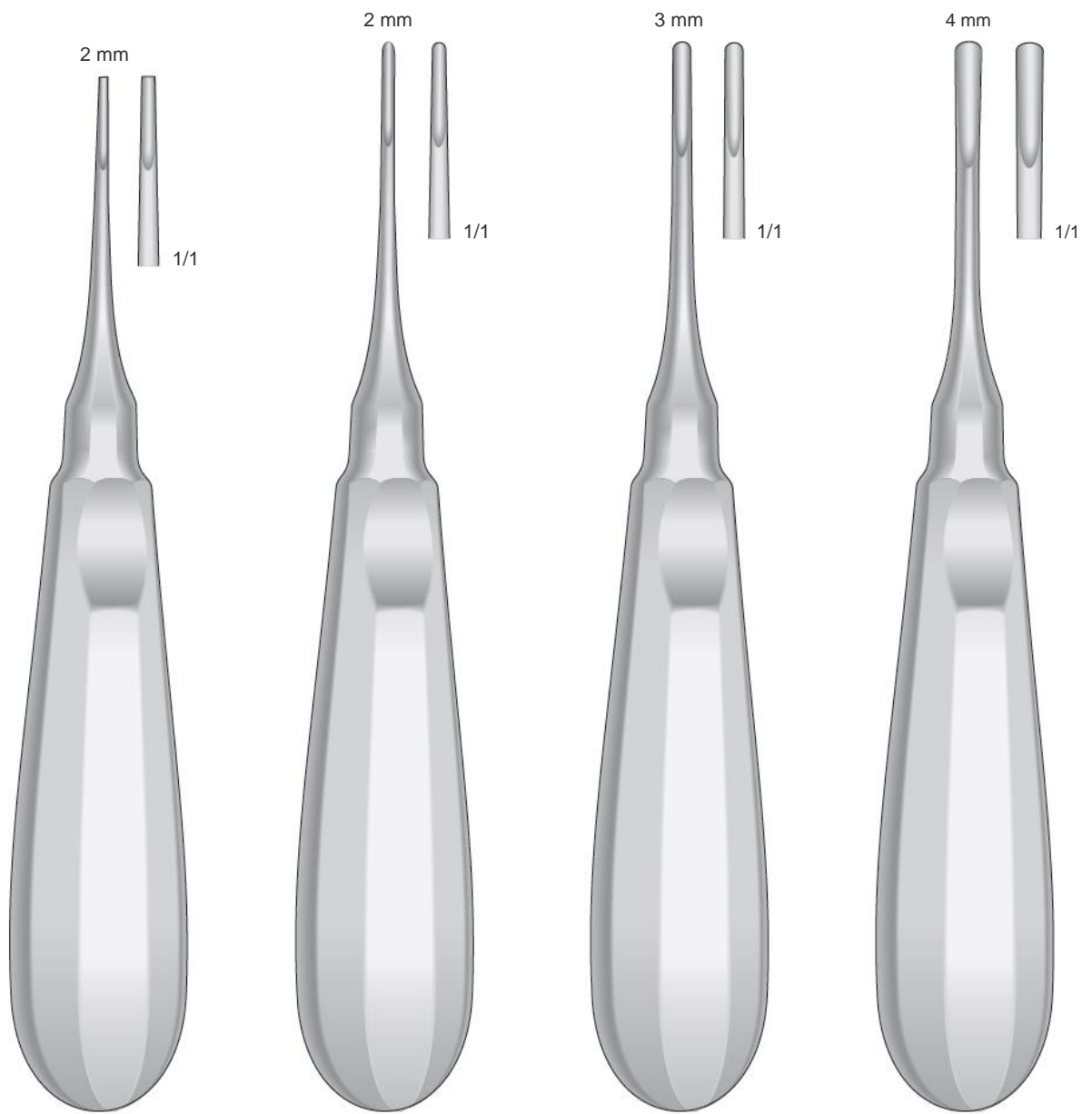
Fig. 77R



SSI-DL-38

Email: sheffieldsurgicalinstruments@gmail.com
Web: www.sheffieldsurgicalinst.com

Wurzelheber Root
Elevators Leve per
radici Elevadores para
raíces Elevateurs à
racines



SSI-BEIN-1T
150 mm

SSI-BEIN-2
155 mm

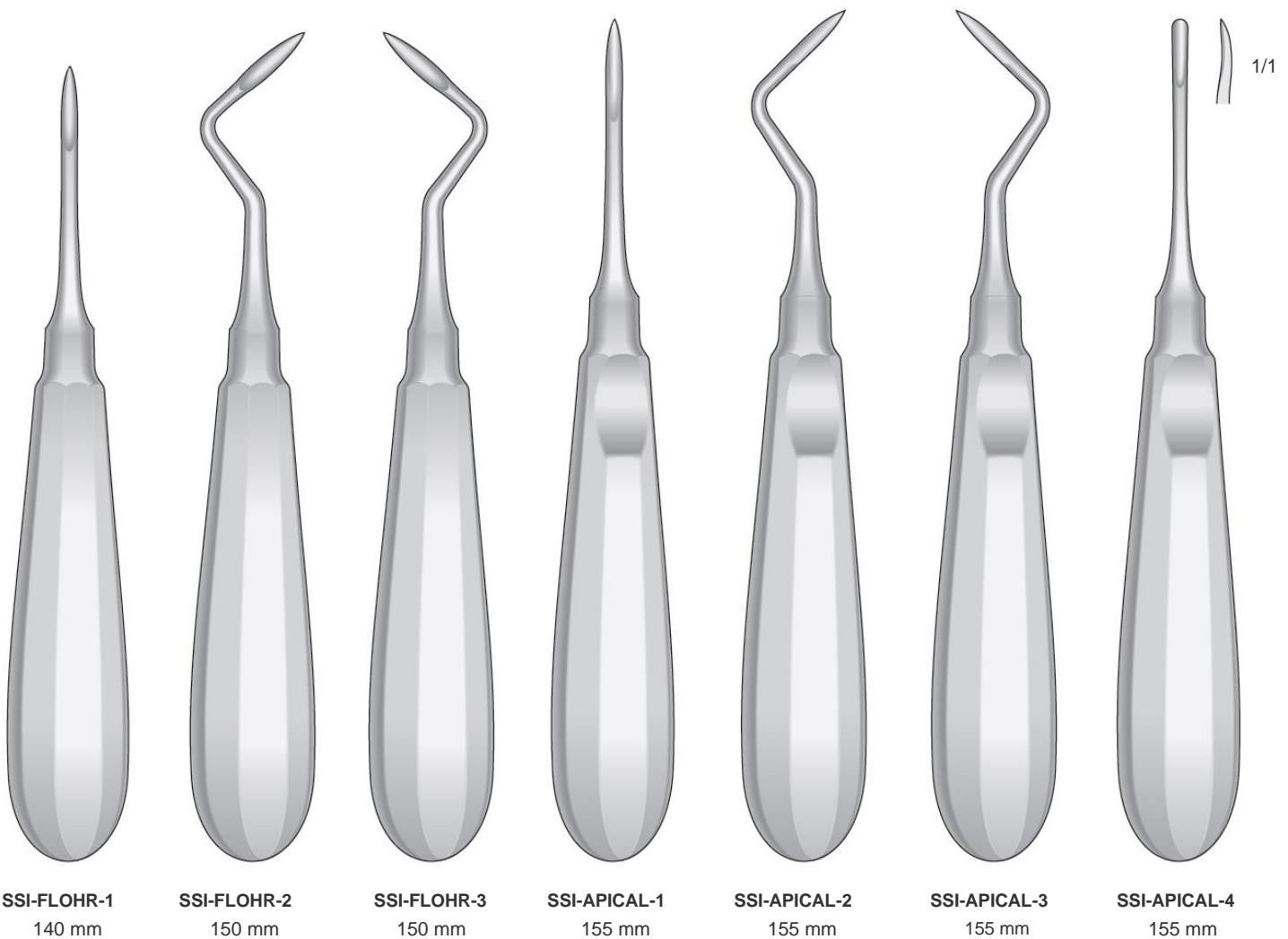
SSI-BEIN-3
155 mm

SSI-BEIN-4
155 mm

Email: sheffieldsurgicalinstruments@gmail.com
Web: www.sheffieldsurgicalinst.com

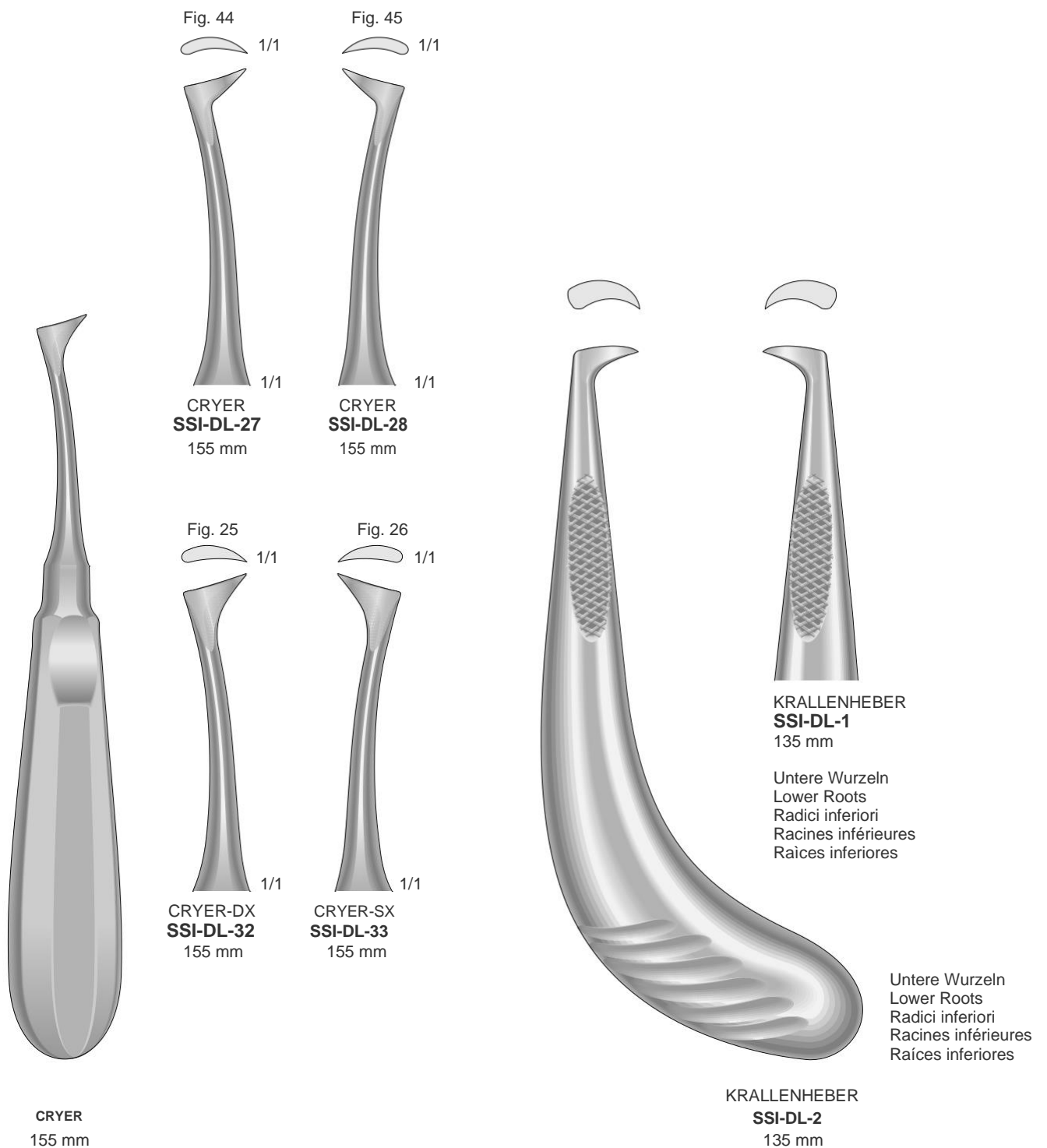


Wurzelheber Root
Elevators Leve per
radici Elevadores para
raíces Elevateurs à
racines



Email: sheffieldsurgicalinstruments@gmail.com
Web: www.sheffieldsurgicalinst.com

Wurzelheber Root
Elevators Leve per
radici Elevadores para
raíces Elevateurs à
racines



Email: sheffieldsurgicalinstruments@gmail.com
Web: www.sheffieldsurgicalinst.com



Wurzelheber Root
Elevators Leve per
radici Elevadores para
raíces Elevateurs à
racines



SSI-MIR-20
Large
160 mm
Angled IN



SSI-MIR-24
Large
160 mm
Angled OUT



SSI-MIR-23
Small
160 mm
Angled IN



SSI-MIR-21
Small
160 mm
Angled OUT



SSI-MIR-22
Straight
160 mm

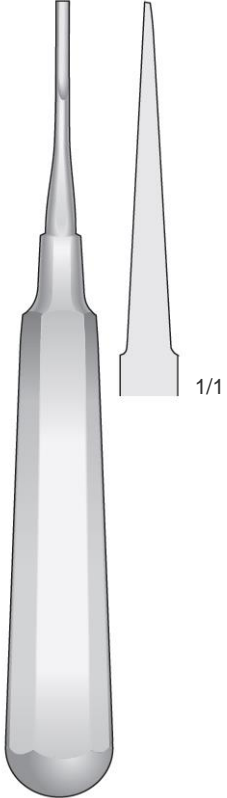


SSI-MIR-25
Bayonet
160 mm



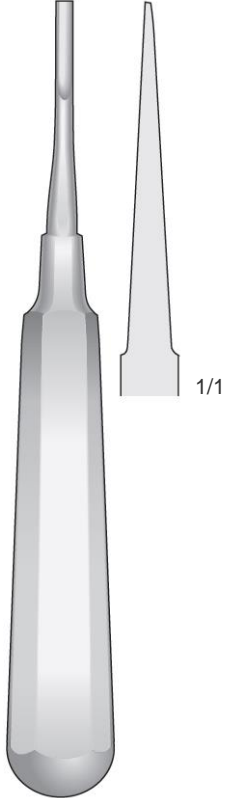
SSI-MIR-26
Curved
160 mm

Fig. 1
2,0 mm



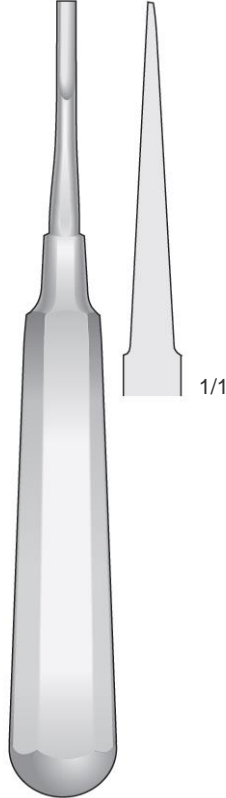
**COUPLAND
SSI-CO-1**
155 mm

Fig. 2
3,6 mm



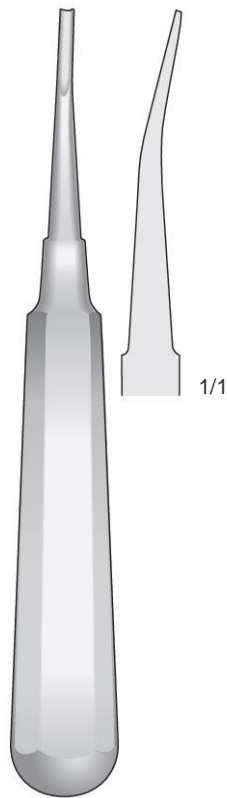
**COUPLAND
SSI-CO-2**
155 mm

Fig. 3
4,2 mm



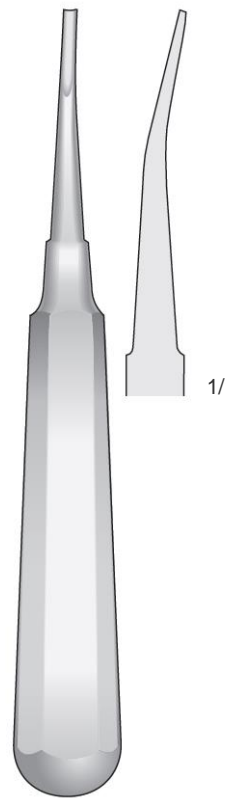
**COUPLAND
SSI-CO-3**
155 mm

Fig. 1
3,0 mm



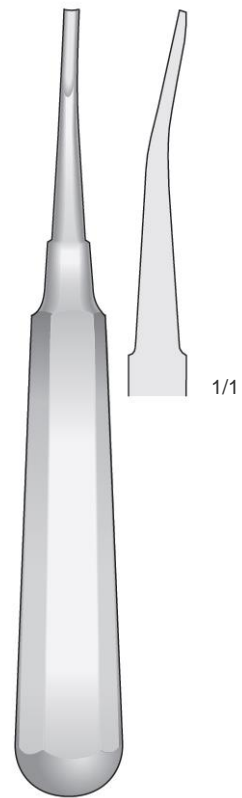
**COUPLAND
SSI-CO-11**
155 mm

Fig. 2
3,6 mm



**COUPLAND
SSI-CO-12**
155 mm

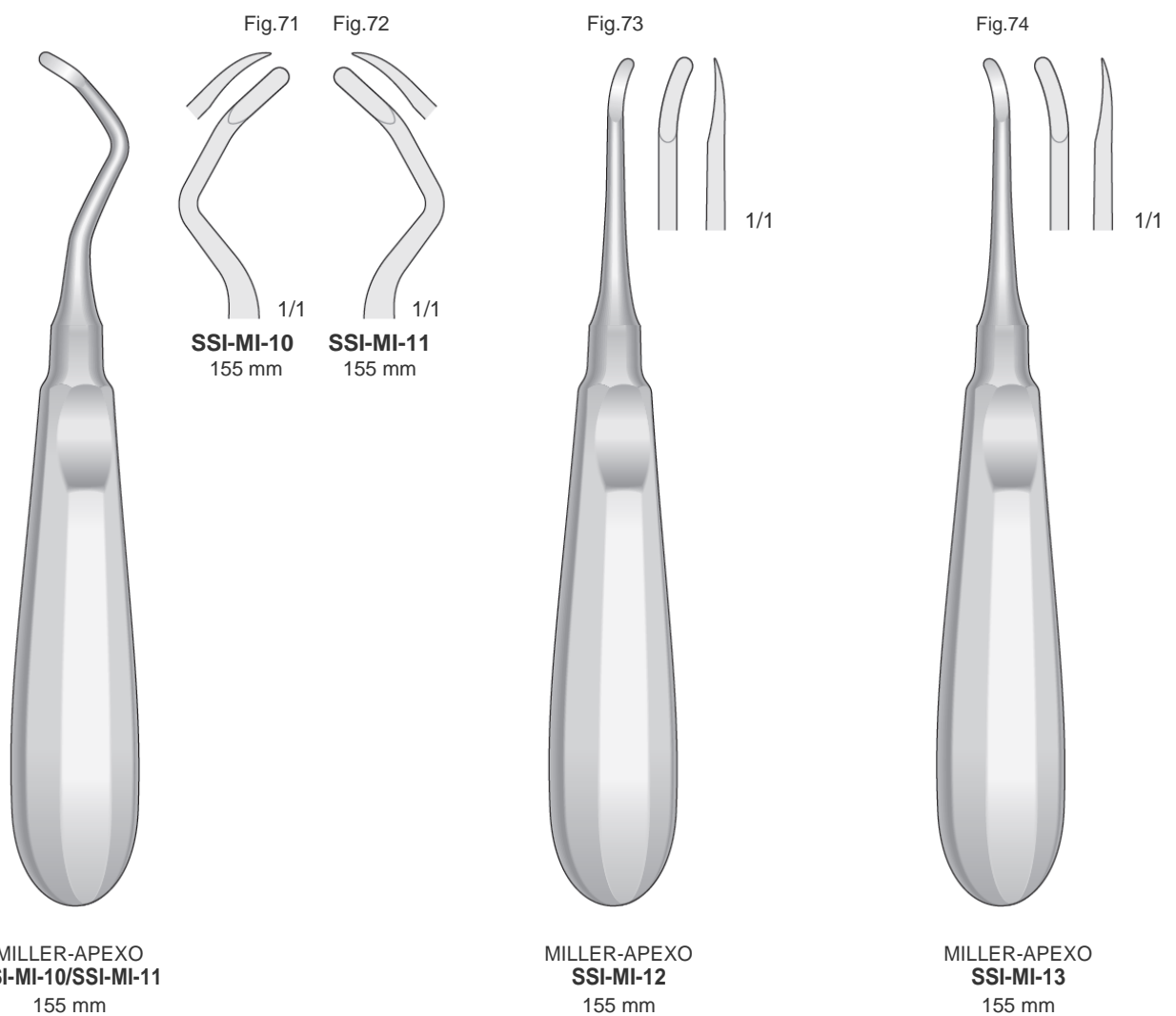
Fig. 3
4,2 mm



**COUPLAND
SSI-CO-13**
155 mm

Email: sheffieldsurgicalinstruments@gmail.com
Web: www.sheffieldsurgicalinst.com

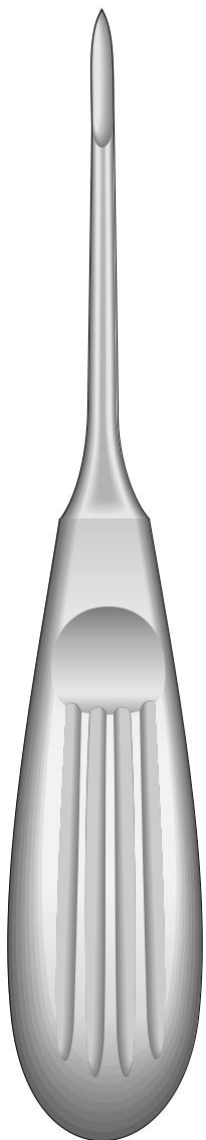
Wurzelheber Root
Elevators Leve per
radici Elevadores para
raíces Elevateurs à
racines



Email: sheffieldsurgicalinstruments@gmail.com
Web: www.sheffieldsurgicalinst.com



Wurzelheber Root
Elevators Leve per
radici Elevadores para
raíces Elevateurs à
racines



HYLIN
SSI-DL-11/SSI-DL-19
145 mm

4 mm



1/1

HYLIN
SSI-DL-11
145 mm

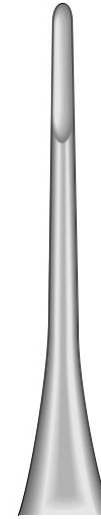
2 mm



1/1

HYLIN-2C
SSI-DL-13
145 mm

3 mm



1/1

HYLIN-3C
SSI-DL-14
145 mm

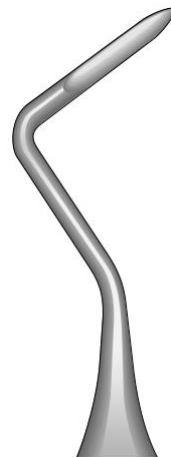
3 mm



1/1

HYLIN-1
SSI-DL-17
145 mm

3 mm



1/1

HYLIN-2
SSI-DL-18
145 mm

3 mm



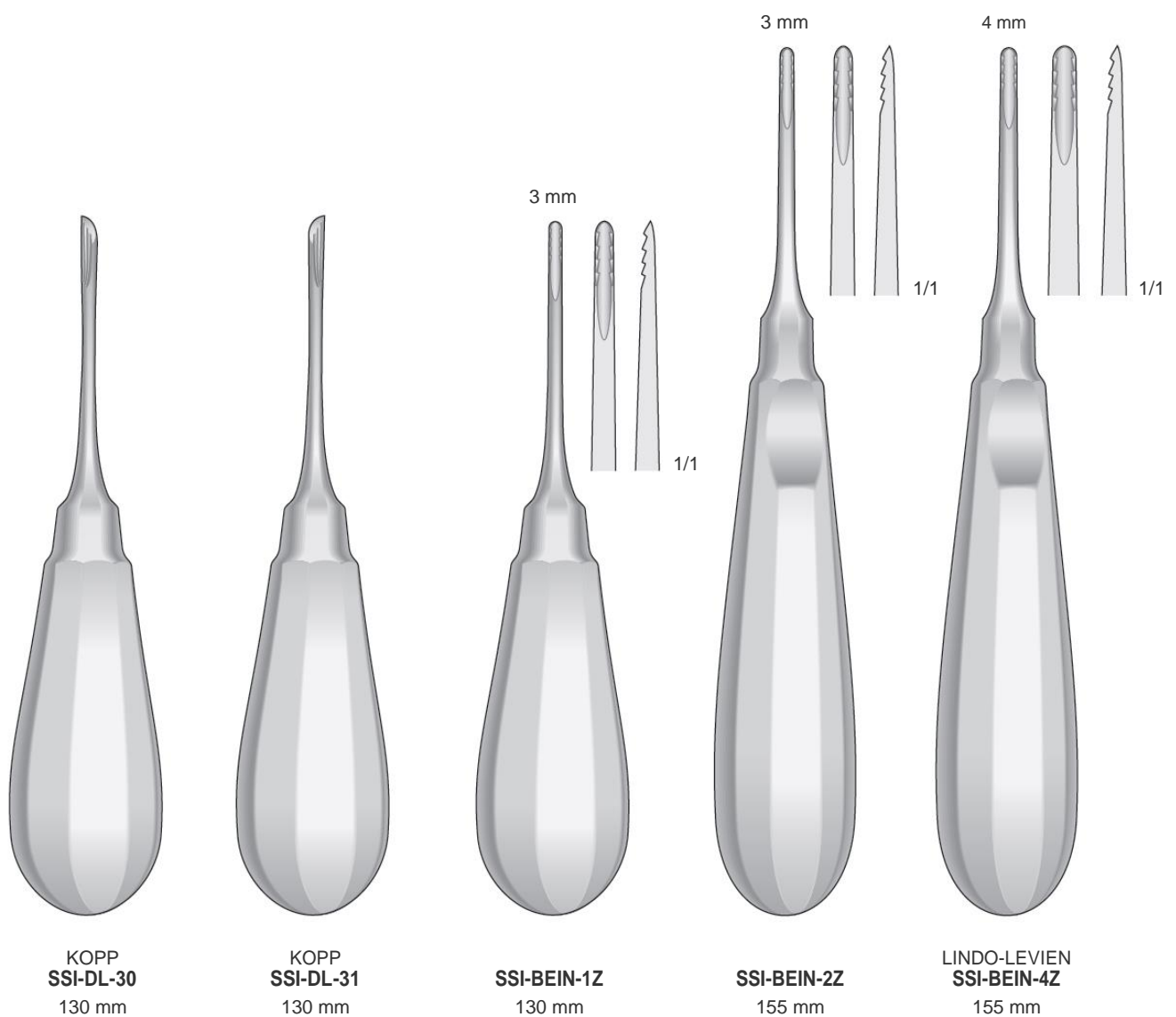
1/1

HYLIN-3
SSI-DL-19
145 mm

Email: sheffieldsurgicalinstruments@gmail.com
Web: www.sheffieldsurgicalinst.com



Wurzelheber Root
Elevators Leve per
radici Elevadores para
raíces Elevateurs à
racines

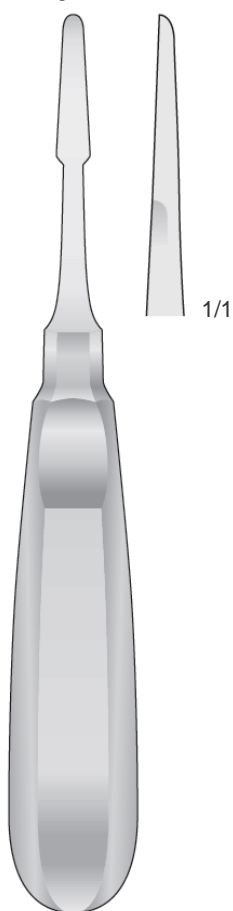


Email: sheffieldsurgicalinstruments@gmail.com
Web: www.sheffieldsurgicalinst.com



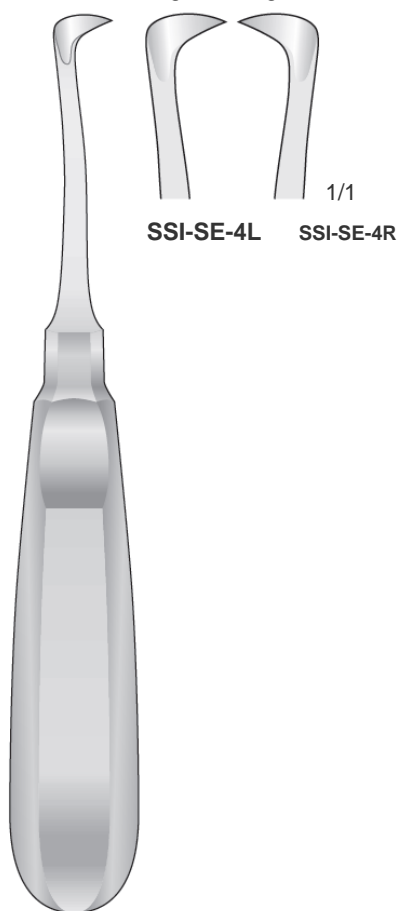
Wurzelheber
Root Elevators
Leve per radici
Elevadores para raíces
Elevateurs à racines

Fig. 25



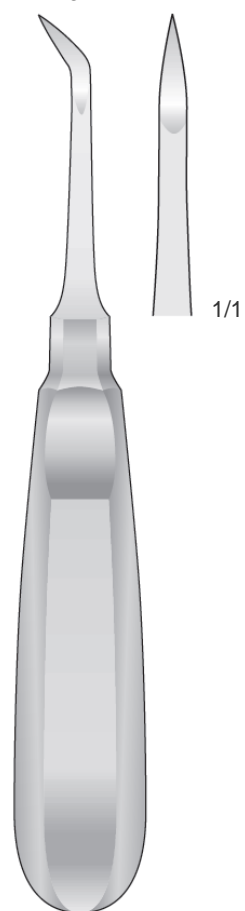
SELDIN
SSI-SE-2
160 mm

Fig. 4L Fig. 4R



SELDIN
SSI-SE-4L/SSI-SE-4R
160 mm

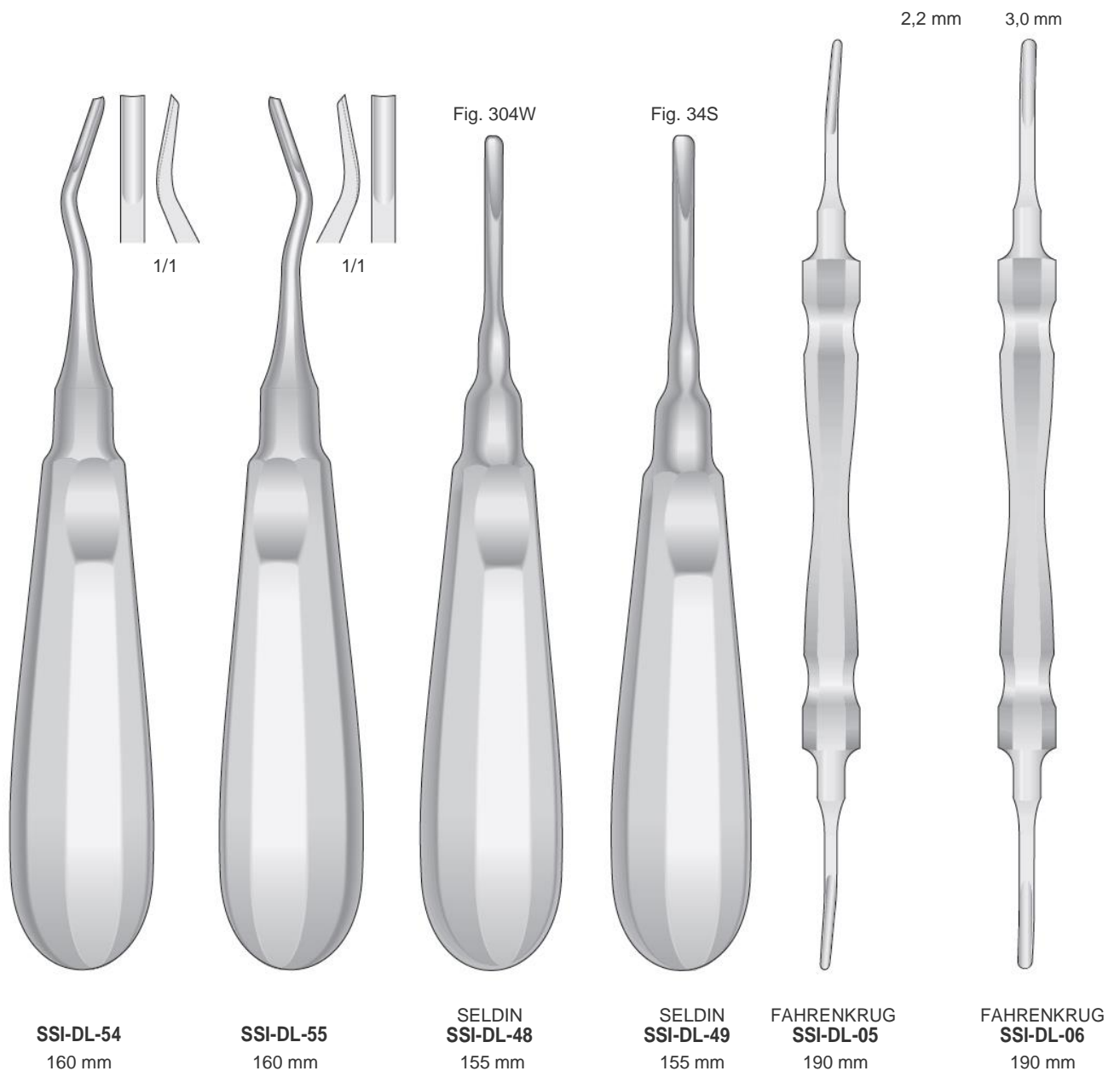
Fig. 8



CRANE PICK
SSI-HP-6
155 mm

Email: sheffieldsurgicalinstruments@gmail.com
Web: www.sheffieldsurgicalinst.com

Wurzelheber Root
Elevators Leve per
radici Elevadores para
raíces Elevateurs à
racines



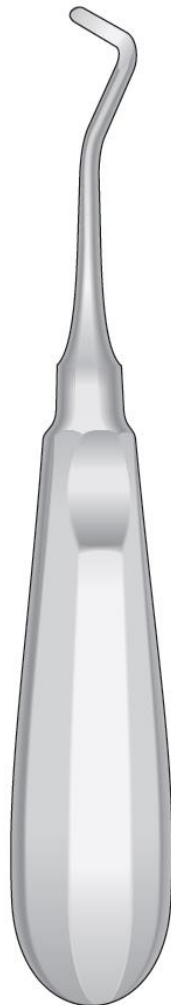
Email: sheffieldsurgicalinstruments@gmail.com
Web: www.sheffieldsurgicalinst.com

Fig. 6

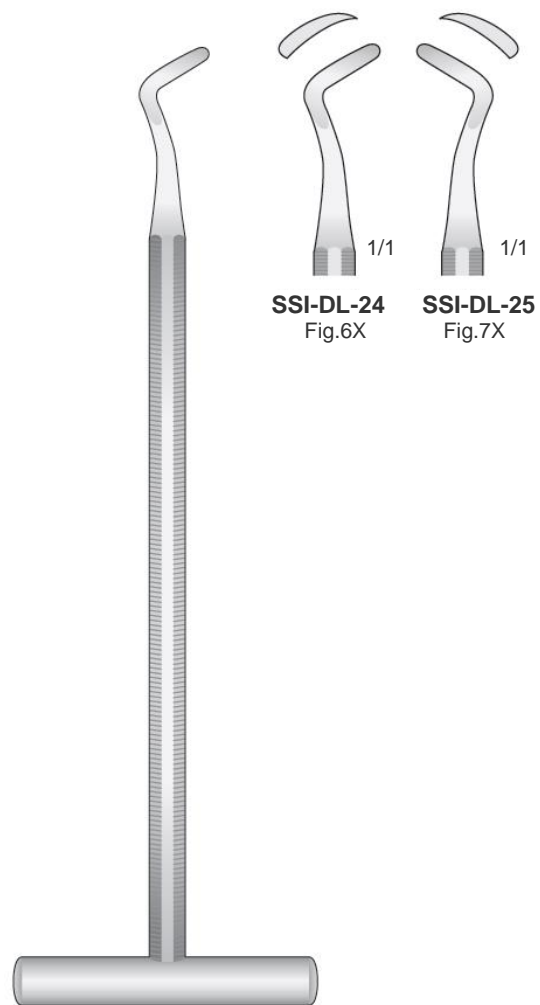


POTT
SSI-DL-98
160 mm

Fig. 7



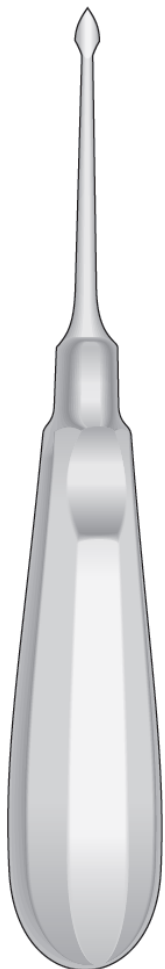
POTT
SSI-DL-99
160 mm



POTT
SSI-DL-24/SSI-DL-25
155 mm

Wurzelheber
 Root Elevators
 Leve per radici
 Elevadores para raíces
 Elevateurs à racines

Syndesmotome
 Syndesmotomes
 Sindesmotomi
 Syndesmôtomos
 Syndesmotomes



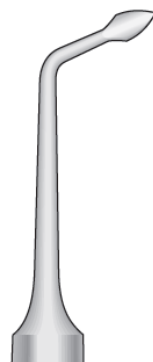
BERNARD
 SSI-DL-73 / SSI-DL-124

Gerade
 Straight
 Diritto
 Rectas
 Droites



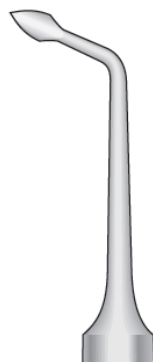
BERNARD
 SSI-DL-73
 150 mm

Links
 Left
 Sinistra
 A la izquierda
 À gauche



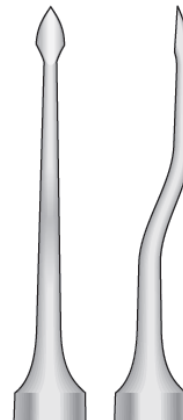
BERNARD
 SSI-DL-74
 140 mm

Rechts
 Right
 Destro
 A la derecha
 À droite

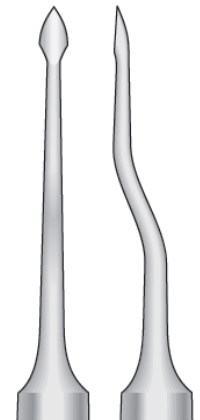


BERNARD
 SSI-DL-75
 140 mm

Bajonett - Bayonet
 Baionetta - Bayoneta
 Baionnette



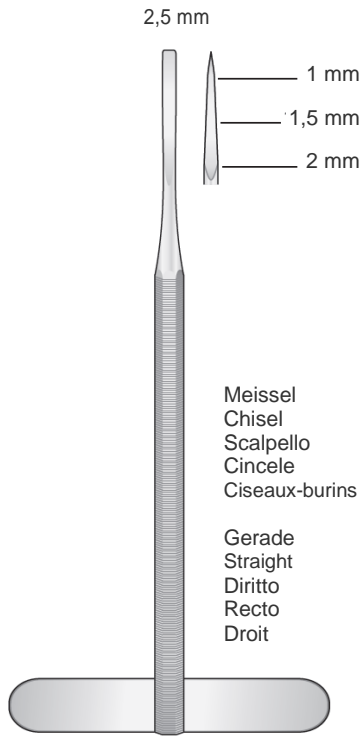
BERNARD
 SSI-DL-123
 150 mm



BERNARD
 SSI-DL-124
 150 mm



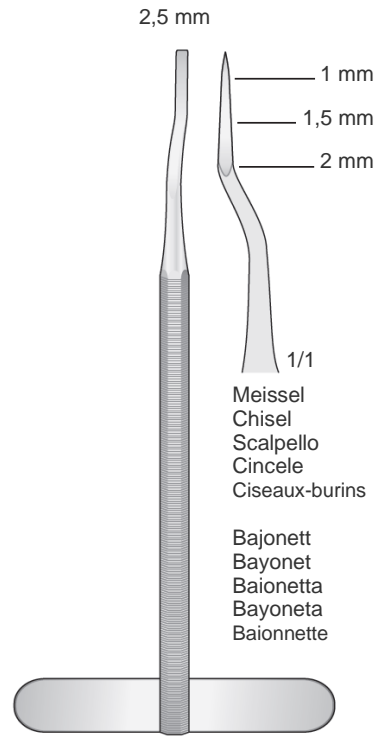
Wurzelheber
 Root Elevators
 Leve per radici
 Elevadores para raíces
 Elevateurs à racines



SSI-DL-88
 130 mm

Meissel
 Chisel
 Scalpello
 Cincele
 Ciseaux-burins

Gerade
 Straight
 Diritto
 Recto
 Droit



SSI-DL-89
 130 mm

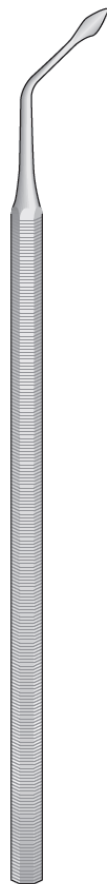
Meissel
 Chisel
 Scalpello
 Cincele
 Ciseaux-burins

Bajonett
 Bayonet
 Baionetta
 Bayoneta
 Baionnette

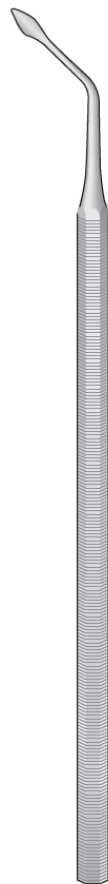
Syndesmotome
 Syndesmotomes
 Sindesmotomo
 Syndesmôtomos
 Syndesmotomes



SSI-DL-63
 158 mm



SSI-DL-62
 152 mm

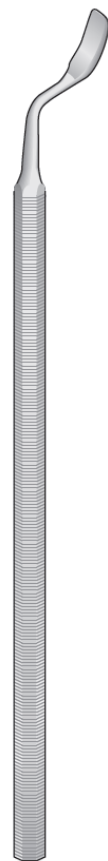


SSI-DL-61
 152 mm

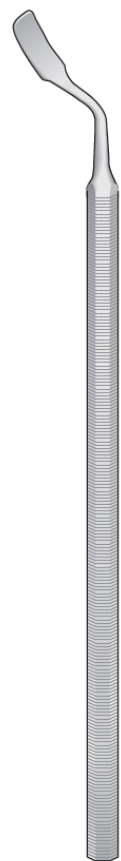
Raspatorien
 Raspatories
 Scollaperiosteo
 Legras
 Rugines



SSI-DL-59
 150 mm



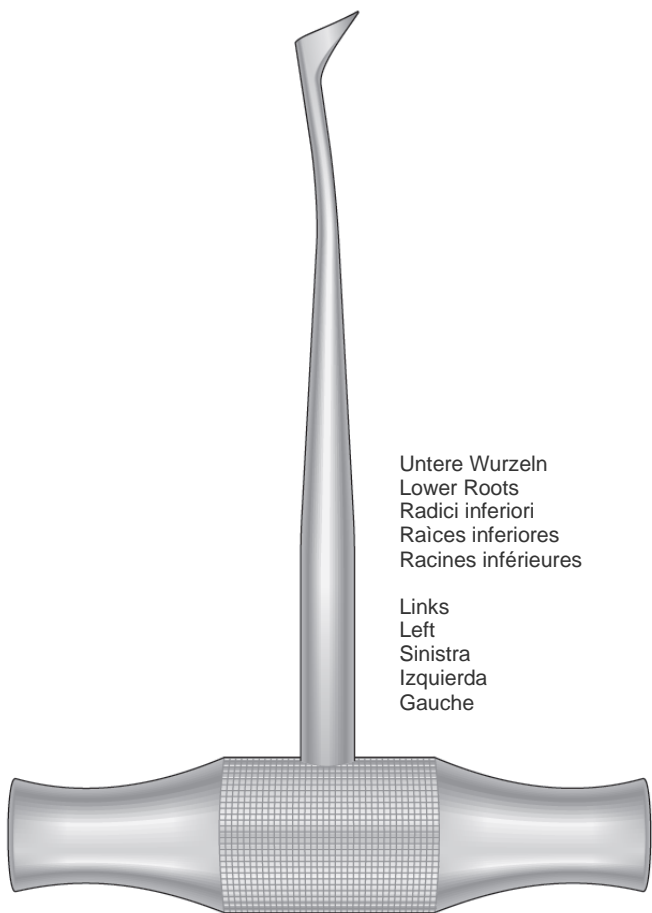
SSI-DL-68
 150 mm



SSI-DL-69
 150 mm

Email: sheffieldsurgicalinstruments@gmail.com
 Web: www.sheffieldsurgicalinst.com

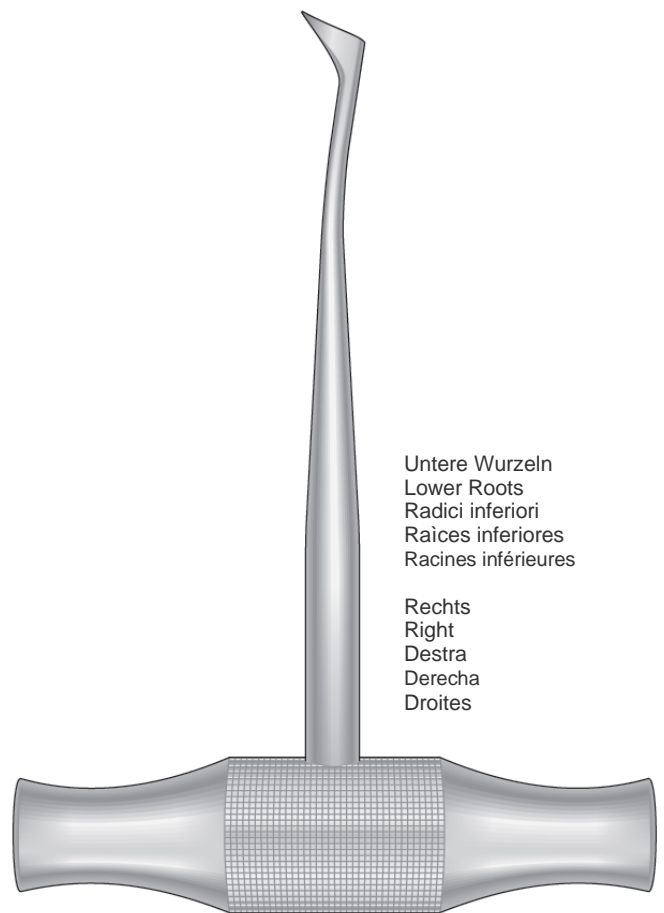
Wurzelheber Root
Elevators Leve per
radici Elevadores para
raíces Elevateurs à
racines



Untere Wurzeln
Lower Roots
Radici inferiori
Raíces inferiores
Racines inférieures

Links
Left
Sinistra
Izquierda
Gauche

WINTER
SSI-DL-100
Fig.1



Untere Wurzeln
Lower Roots
Radici inferiori
Raíces inferiores
Racines inférieures

Rechts
Right
Dextra
Derecha
Droites

WINTER
SSI-DL-101
Fig.2

Email: sheffieldsurgicalinstruments@gmail.com
Web: www.sheffieldsurgicalinst.com

Fig. 1L



WINTER
SSI-DL-64
120 mm

Fig. 1R



WINTER
SSI-DL-65
120 mm

Fig. 14L



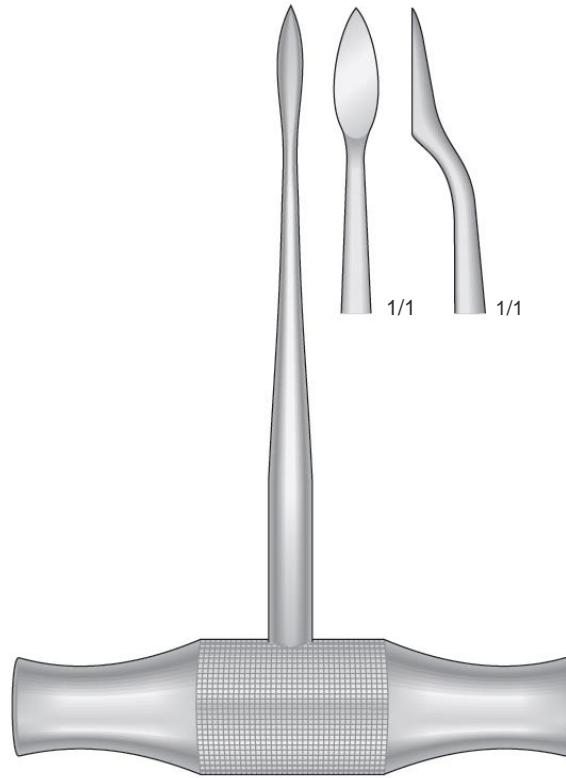
WINTER
SSI-DL-66
125 mm

Fig. 14R

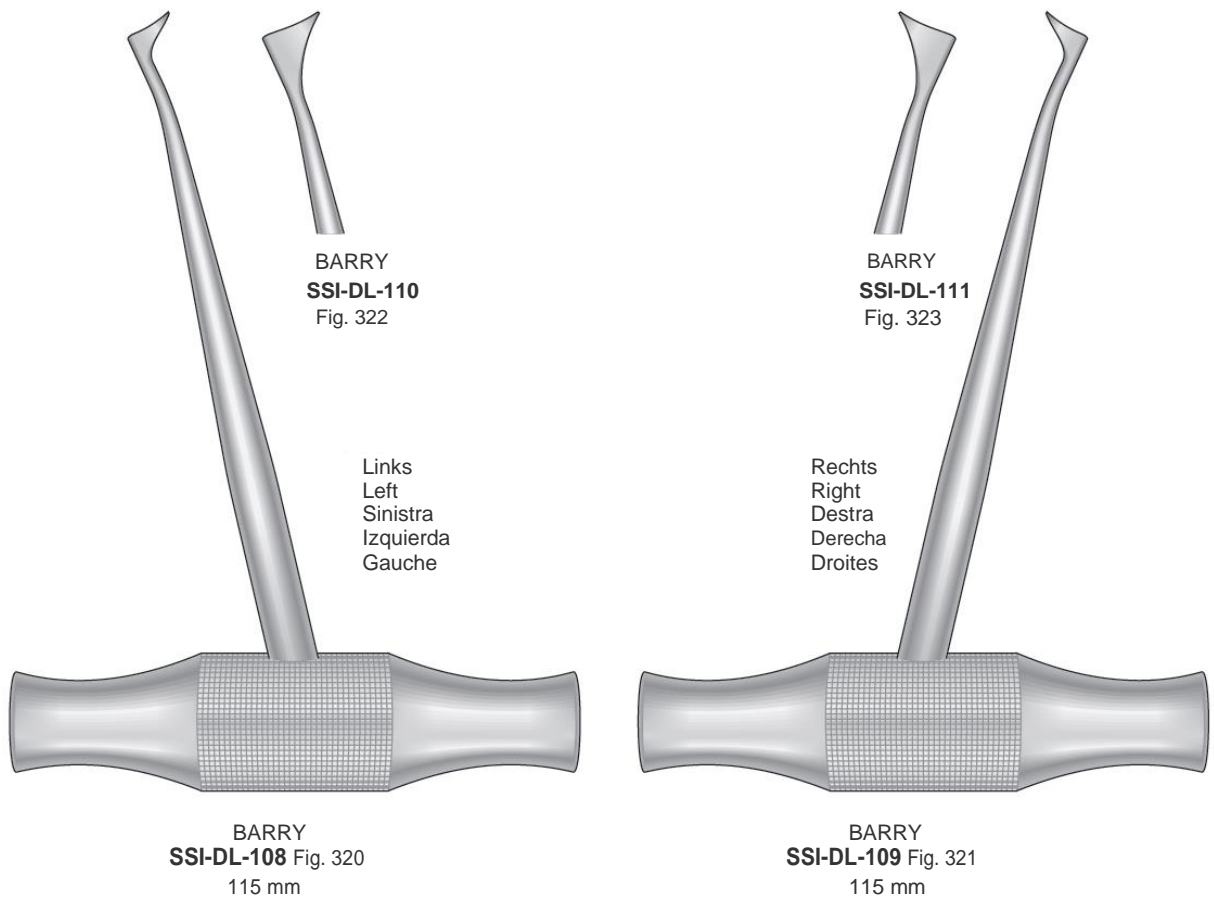


WINTER
SSI-DL-67
125 mm

Wurzelheber Root
Elevators Leve per
radici Elevadores para
raíces Elevateurs à
racines



LECLUSE
SSI-DL-90
130 mm



Email: sheffieldsurgicalinstruments@gmail.com
Web: www.sheffieldsurgicalinst.com



Wurzelheber Root
Elevators Leve per
radici Elevadores para
raíces Elevateurs à
racines

3 mm



SSI-LA-1
160 mm

3 mm



SSI-LA-2
160 mm

4 mm



SSI-LA-3
160 mm

4 mm



SSI-LA-4
160 mm

4,5 mm



SSI-LA-5
160 mm

4,5 mm



SSI-LA-6
160 mm

Email: sheffieldsurgicalinstruments@gmail.com
Web: www.sheffieldsurgicalinst.com

Wurzelheber Root
Elevators Leve per
radici Elevadores para
raíces Elevateurs à
racines

3 mm



SSI-LA-7
160 mm

3 mm



SSI-LA-8
160 mm

4 mm



SSI-LA-9
160 mm

4 mm



SSI-LA-10
160 mm

Email: sheffieldsurgicalinstruments@gmail.com
Web: www.sheffieldsurgicalinst.com



Wurzelheber Root
Elevators Leve per
radici Elevadores para
raíces Elevateurs à
racines

2 mm



SSI-LA-11
155 mm

3 mm



SSI-LA-12
155 mm

4 mm



SSI-LA-13
155 mm



SSI-LA-16
160 mm



SSI-LA-17
160 mm

Email: sheffieldsurgicalinstruments@gmail.com
Web: www.sheffieldsurgicalinst.com

Wurzelheber Root
Elevators Leve per
radici Elevadores para
raíces Elevateurs à
racines

3 mm



SSI-LA-20
160 mm

3 mm



SSI-LA-21
160 mm

4 mm



SSI-LA-22
160 mm

4 mm



SSI-LA-23
160 mm

Email: sheffieldsurgicalinstruments@gmail.com
Web: www.sheffieldsurgicalinst.com



Syndesmotome
Syndesmotomes
Sindesmotomo
Syndesmòtomos
Syndesmotomes



Massiv
Solid
Manico
Pieno
Massif

CHOMPRET
SSI-CH-11
150 mm



Massiv
Solid
Manico
Pieno
Massif

CHOMPRET
SSI-CH-12
150 mm



Massiv
Solid
Manico
Pieno
Massif

CHOMPRET
SSI-CH-13
150 mm



Massiv
Solid
Manico
Pieno
Massif

CHOMPRET
SSI-CH-14
145 mm



CHOMPRET
SSI-CH-1
165 mm



CHOMPRET
SSI-CH-2
165 mm



CHOMPRET
SSI-CH-3
165 mm



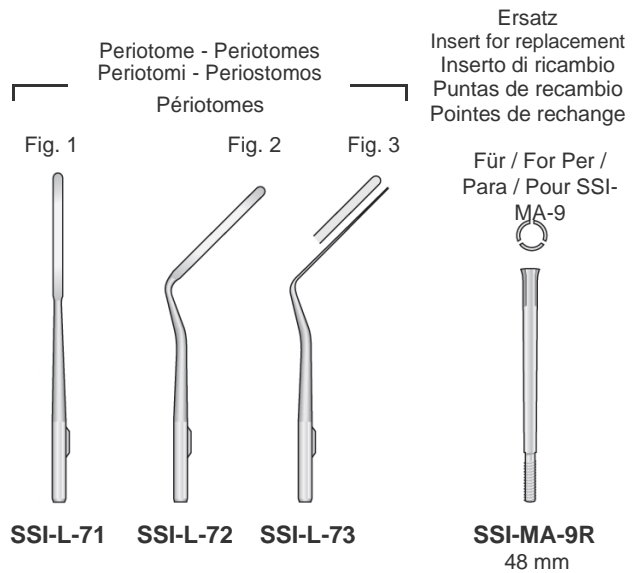
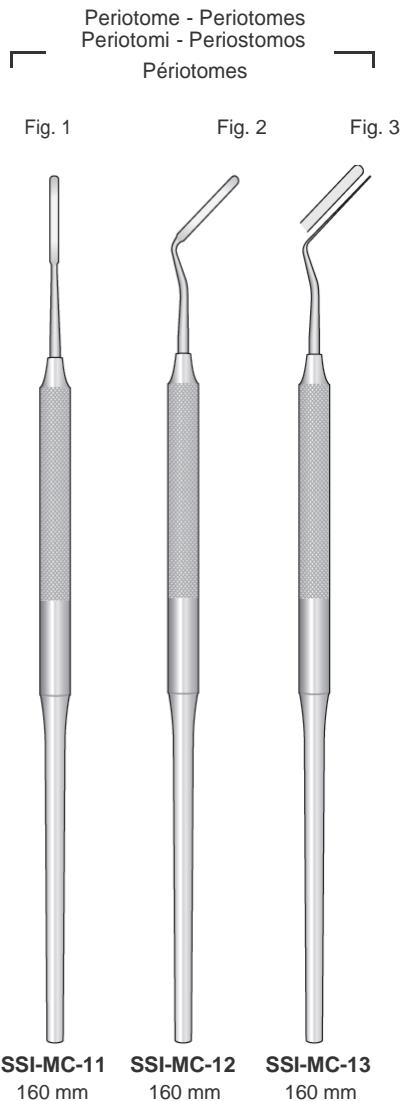
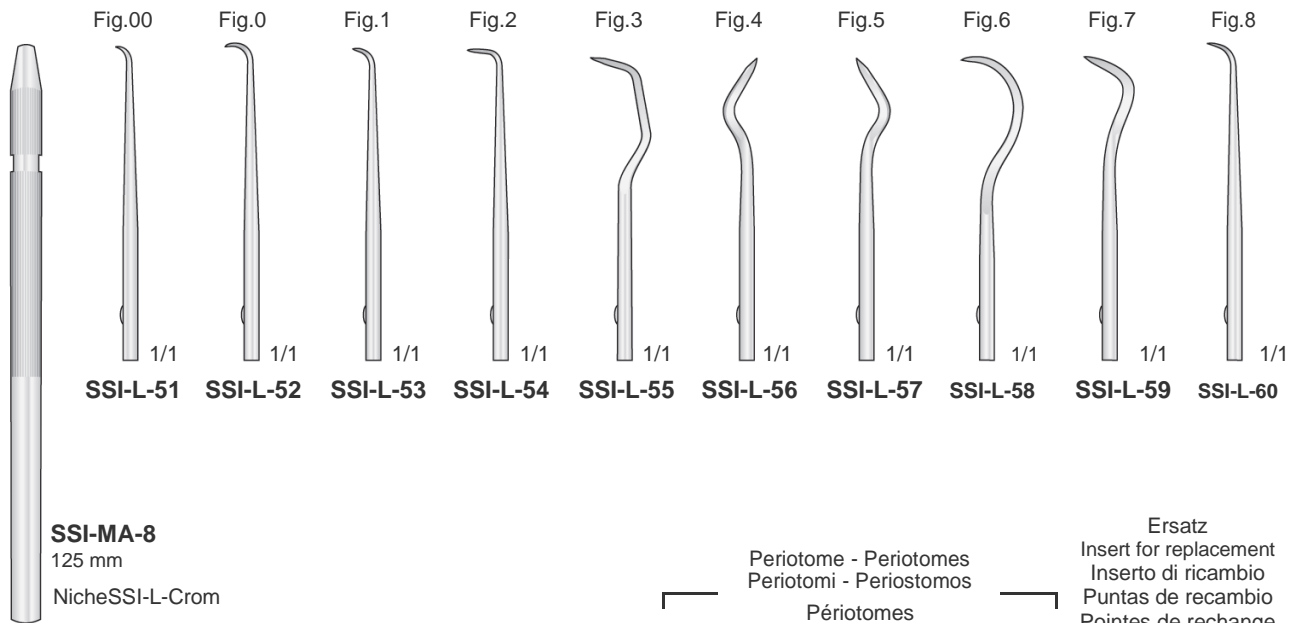
CHOMPRET
SSI-CH-4
160 mm

Email: sheffieldsurgicalinstruments@gmail.com
Web: www.sheffieldsurgicalinst.com



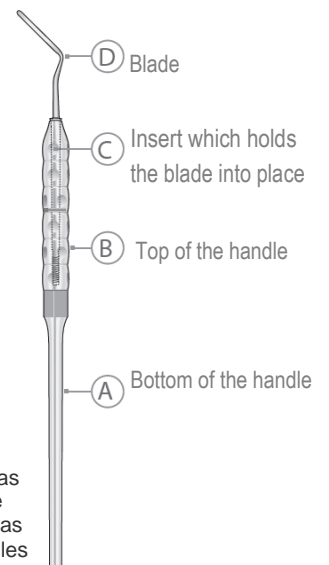
Zahnreiniger - Periotome
 Scalers - Periotomes
 Ablatori di tartaro - Periotomi
 Limpiadores de sarro - Periotomos
 Detarteurs - Périotomes

MORSE - SCALERS



SSI-MA-9
 Handle
 140 mm
 Rostfrei
 Stainless Steel
 Inox

SSI-MC-70
 (SSI-MA-9 + SSI-L-71,
 SSI-L-72, SSI-L-73)
 Komplet mit 1 Griff + 3 Spatel
 Complete with 1 Handle + 3 Spatulas
 Completo di 1 Manico +3 Spatole
 Completo con 1 mango + 3 Espátulas
 Complete avec 1 Manche + 3 Spatules



Email: sheffieldsurgicalinstruments@gmail.com
 Web: www.sheffieldsurgicalinst.com



Syndesmotome
 Syndesmotomes
 Sindesmotomi
 Syndesmótomos
 Syndesmotomes

SSI-SDM-C

Komplett mit 2 Griffe + 20 Klingen
 Complete with 2 Handles + 20 Blades
 Completo di 2 Manici + 20 lame
 Completo con 2 mangos + 20 hojas
 Complete avec 2 Manches + 20 lames

SSI-SD-M

Griff
 Handle
 Manico
 Mango
 Manche

SSI-SDM-9

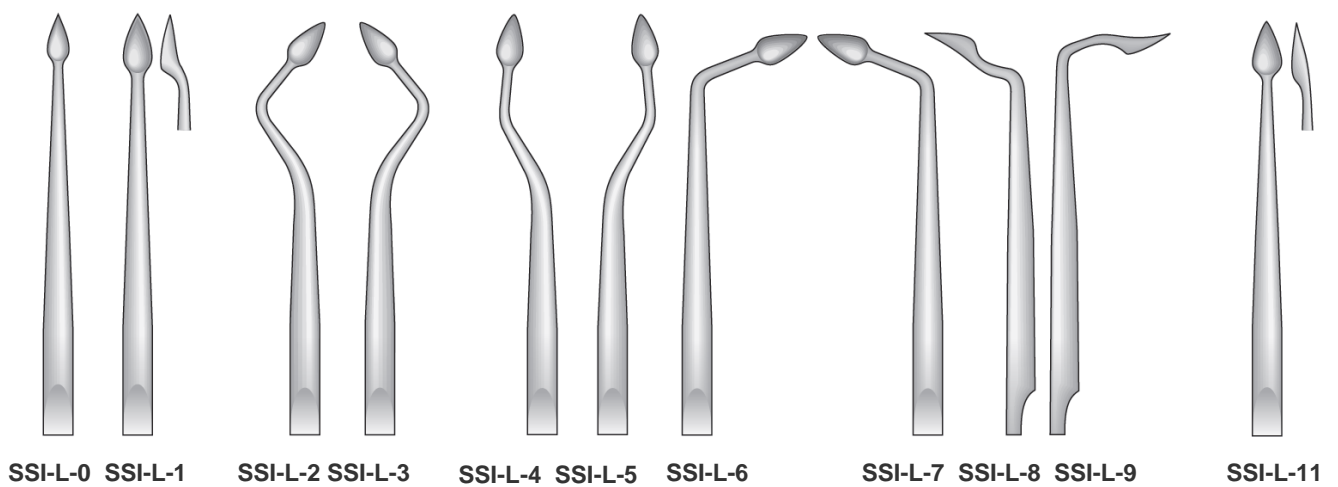
Komplett mit 2 Griffe + 9 Klingen APICALI
 Complete with 2 Handles + 9 Blades APICALI
 Completo di 2 Manici + 9 lame APICALI
 Completo con 2 mangos + 9 hojas APICALI
 Complete avec 2 Manches + 9 lames APICALI

SSI-SDM-11

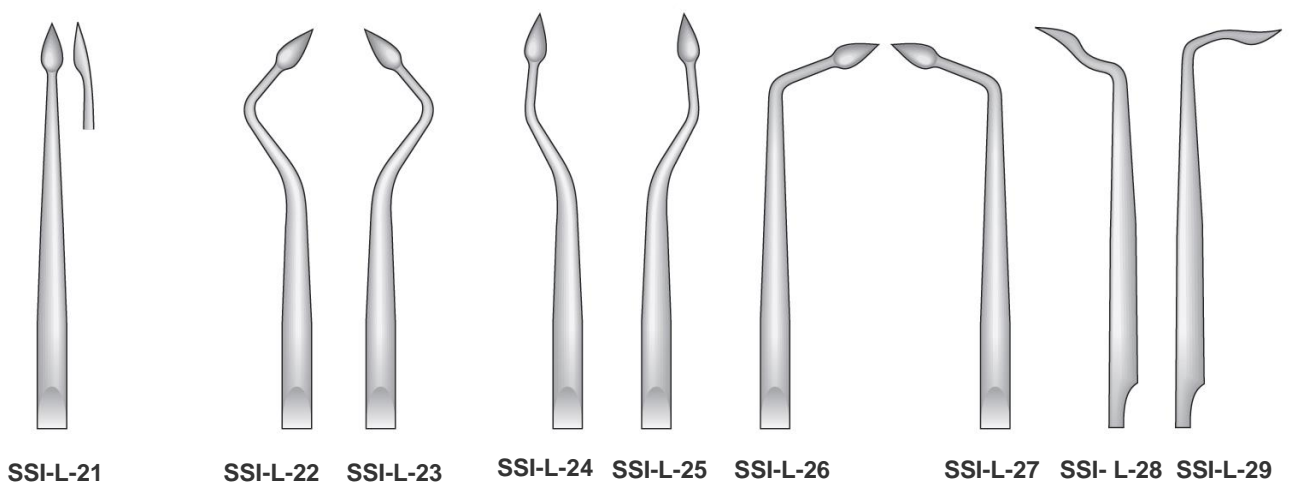
Komplett mit 2 Griffe + 11 Klingen CERVICALI
 Complete with 2 Handles + 11 Blades CERVICALI
 Completo di 2 Manici + 11 lame CERVICALI
 Completo con 2 mangos + 11 hojas CERVICALI
 Complete avec 2 Manches + 11 lames CERVICALI



Lame CERVICALI



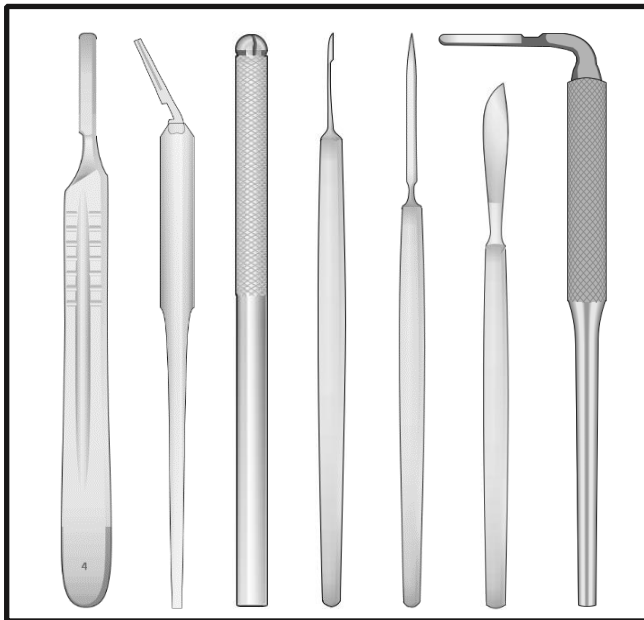
Lame CERVICALI



SSI-SD-M

Email: sheffieldsurgicalinstruments@gmail.com
 Web: www.sheffieldsurgicalinst.com

Scalpel Blades and Handles
Skalpellklingen und Skalpellgriffe
Lames et manches de bistouri
Hojas y mangos de bisturí
Lame e manici per bisturi



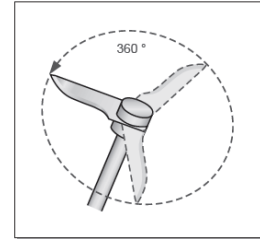
Sheffield Surgical is highly experienced Manufacturer & exporter of high quality Dental Instruments and also in the field of General Surgery, Bone Surgery an Orthopedic Instruments.





Skalpelligriffe
Scalpel Handles
Manici porta lame
Mangos de bisturí
Manches de bistouri

Für Mikro-Klingen
For Micro Blades
Per micro lame
Para micro Hojas
Pour Micro-Lame de bistouris



SSI-NK-1
100 mm



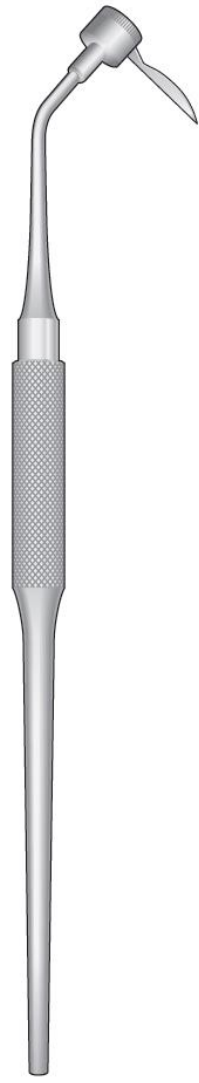
SSI-NK-3
130 mm



SSI-NK-2
150 mm



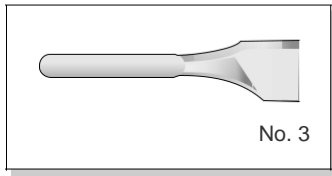
SSI-MA-B16
120 mm



SSI-GB-4
165 mm

Email: sheffieldsurgicalinstruments@gmail.com
Web: www.sheffieldsurgicalinst.com

Skalpelle und Skalpellgriffe
 Scalpel Blades and Handle
 Lame e manici per bisturi
 Hojas y mangos de bisturí
 Lames et manches de bistouri



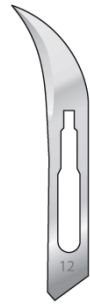
Packungen à 100
 Packages of 100 ea
 Scatole da 100 pezzi
 Cajas de 100 c/u
 Boîtes de 100 pièces



SSI-LB-10
Fig. 10



SSI-LB-11
Fig. 11



SSI-LB-12
Fig. 12



SSI-LB-12D
Fig. 12D



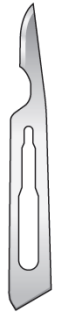
SSI-LB-13
Fig. 13



SSI-LB-15
Fig. 15



SSI-LB-15A
Fig. 15A



SSI-LB-15C
Fig. 15C



SSI-MA-B3



SSI-MA-B3M
Fig. 3M



SSI-MA-B7



SSI-MA-B7K



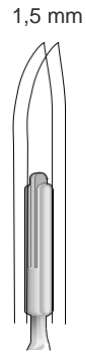
SSI-MA-B1
Fig. 5



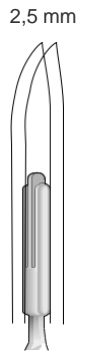
SSI-MA-B2
Fig. 5A



SSI-MA-B8 / SSI-MA-B9
155 mm



SSI-MA-B8



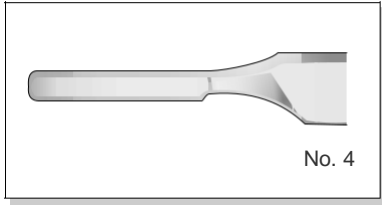
SSI-MA-B9

Doppelt Skalpellgriff
 Scalpel Handle double Blade
 Manico per bisturi a doppia lama
 Mango de bisturí doble hojas
 Manche pour bistouri double-lames

Email: sheffieldsurgicalinstruments@gmail.com
 Web: www.sheffieldsurgicalinst.com



Skalpelle Scalpel
Blades Lame per
bisturi Hojas de
bisturí Lames de
bistouri



Packungen à 100
Packages of 100 ea
Scatole da 100 pezzi
Cajas de 100 c/u
Boîtes de 100 pièces



SSI-LB-18
Fig. 18



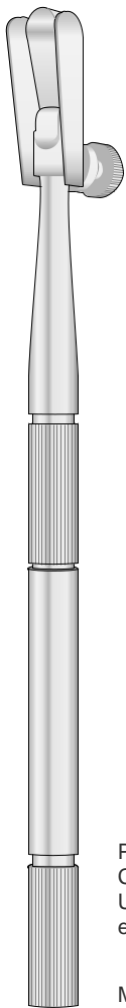
SSI-LB-20
Fig. 20



SSI-LB-21
Fig. 21



SSI-LB-23
Fig. 23



PAQUETTE
BLADE HOLDER
SSI-GB-2
160 mm

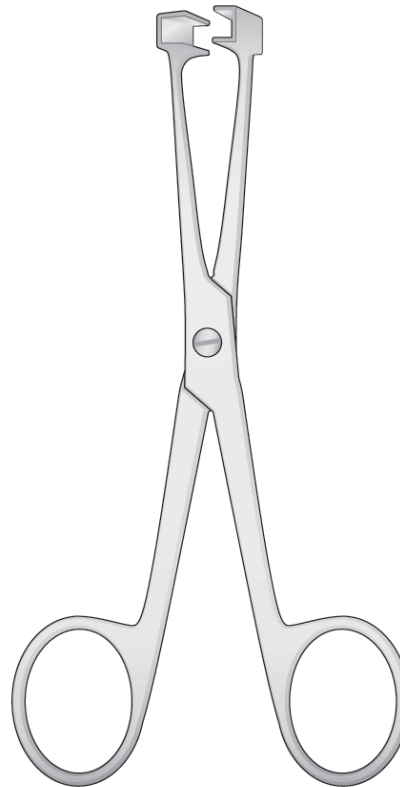
Palatal, Gingival,
Connective Tissue Grafts
Uses standard double-
edged razor blade

Mucotomo

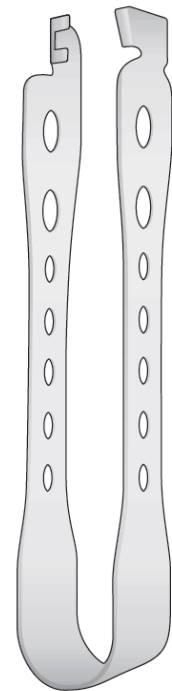


SSI-MA-B4
Fig. 4

Klingentfemer
Scalpel blade removing forceps
Pinze togli lama
Pinza para quitar hojas de bisturís
Pince pour enlever les lames de bistouris



SSI-GS-18
135 mm

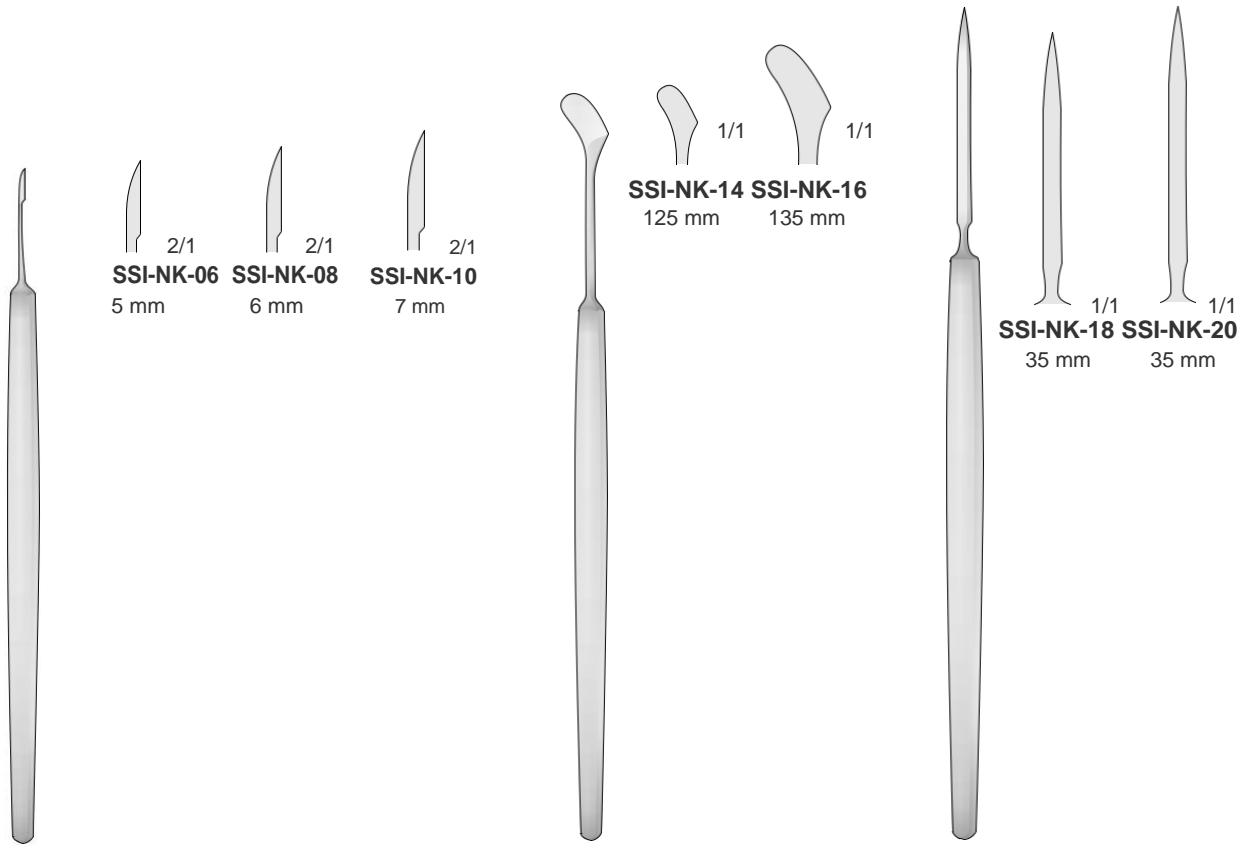


SSI-GS-16
115 mm

Email: sheffieldsurgicalinstruments@gmail.com
Web: www.sheffieldsurgicalinst.com



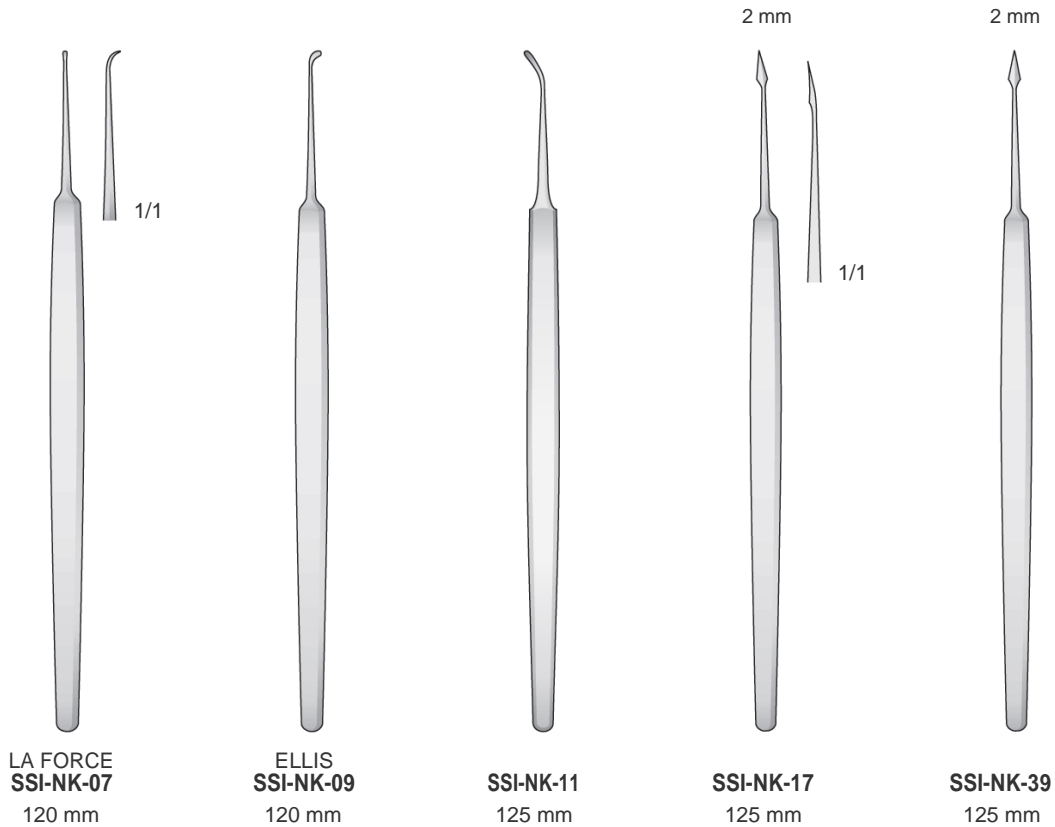
Messer
Knives
Coltelli
Cuchillos
Couteaux



ZIEGLER
SSI-NK-06/SSI-NK-10
115 mm

GRAEFE
SSI-NK-14/SSI-NK-16

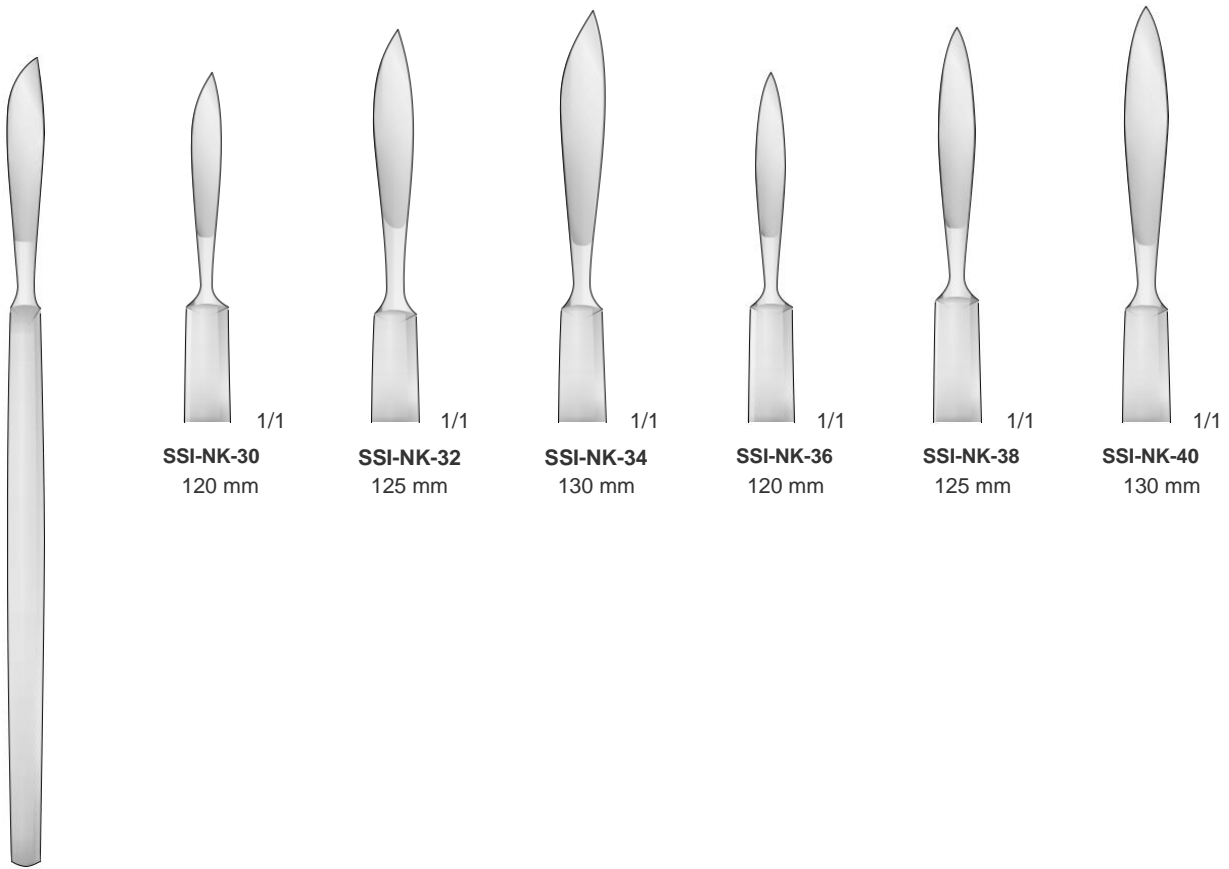
GRAEFE
SSI-NK-18/SSI-NK-20
140 mm



Email: sheffieldsurgicalinstruments@gmail.com
Web: www.sheffieldsurgicalinst.com



Messer
Knives
Coltelli
Cuchillos
Couteaux



SSI-NK-30
120 mm

SSI-NK-32
125 mm

SSI-NK-34
130 mm

SSI-NK-36
120 mm

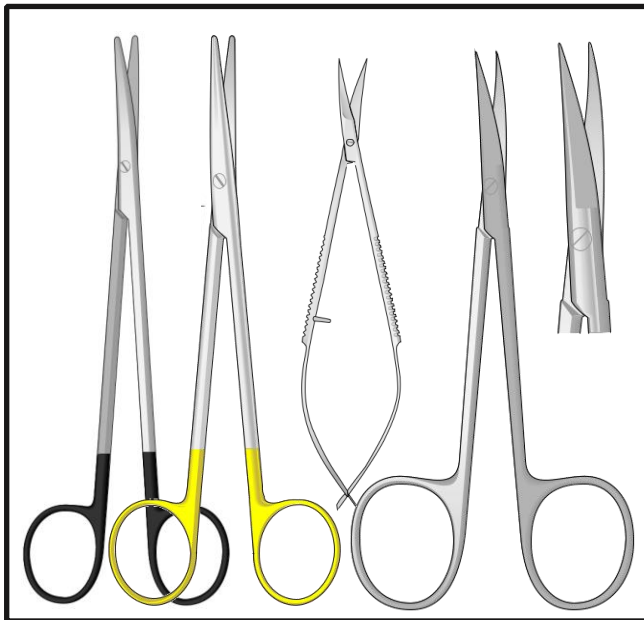
SSI-NK-38
125 mm

SSI-NK-40
130 mm

ADM-NK-30/ADM-NK-40

Email: sheffieldsurgicalinstruments@gmail.com
Web: www.sheffieldsurgicalinst.com

Surgical Scissors
Chirurgische Scheren
Ciseaux chirurgicaux
Tijeras quirúrgicas
Forbici Chirurgiche

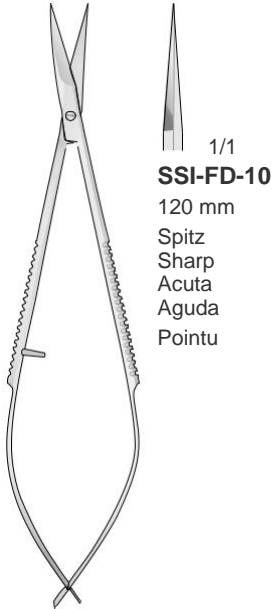


Sheffield Surgical is highly experienced Manufacturer & exporter of high quality Dental Instruments and also in the field of General Surgery, Bone Surgery an Orthopedic Instruments.



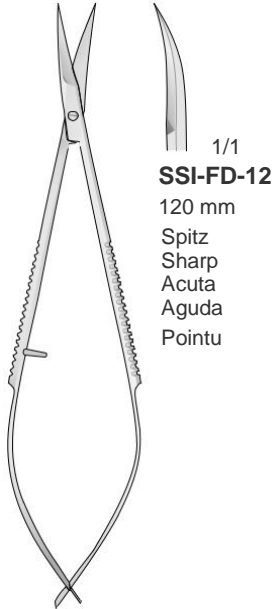


Mikro-Scheren
 Micro Scissors
 Micro Forbici
 Micro Tijeras
 Micro Ciseaux



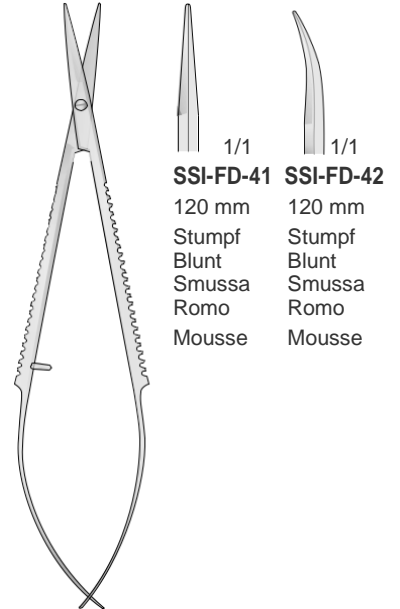
1/1
SSI-FD-10
 120 mm
 Spitz
 Sharp
 Acuta
 Aguda
 Pointu

NOYES
SSI-FD-10
 120 mm



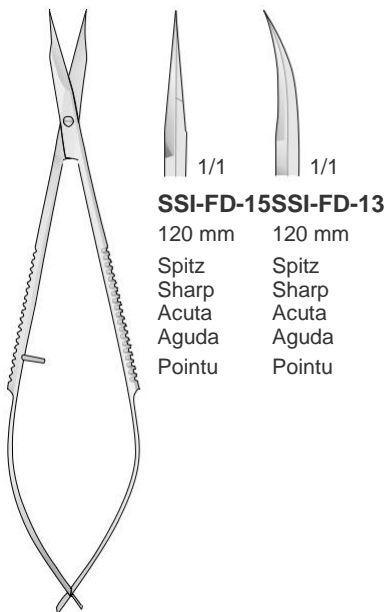
1/1
SSI-FD-12
 120 mm
 Spitz
 Sharp
 Acuta
 Aguda
 Pointu

NOYES
SSI-FD-12
 120 mm



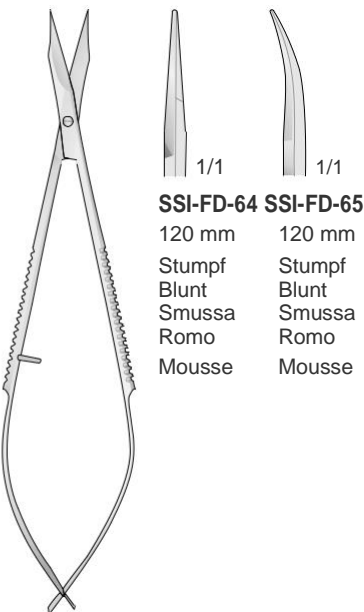
1/1 1/1
SSI-FD-41 SSI-FD-42
 120 mm 120 mm
 Stumpf Stumpf
 Blunt Blunt
 Smussa Smussa
 Romo Romo
 Mousse Mousse

SSI-FD-41/SSI-FD-42
 120 mm



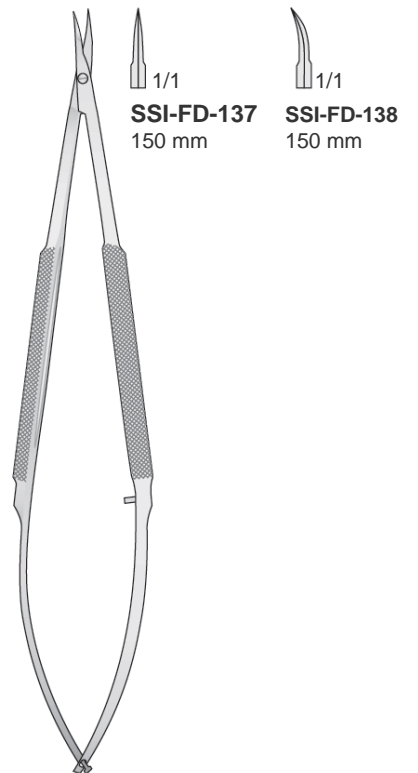
1/1 1/1
SSI-FD-15 SSI-FD-13
 120 mm 120 mm
 Spitz Spitz
 Sharp Sharp
 Acuta Acuta
 Aguda Aguda
 Pointu Pointu

WESTCOTT
SSI-FD-13/SSI-FD-15
 120 mm



1/1 1/1
SSI-FD-64 SSI-FD-65
 120 mm 120 mm
 Stumpf Stumpf
 Blunt Blunt
 Smussa Smussa
 Romo Romo
 Mousse Mousse

WESTCOTT
SSI-FD-64/SSI-FD-65
 120 mm



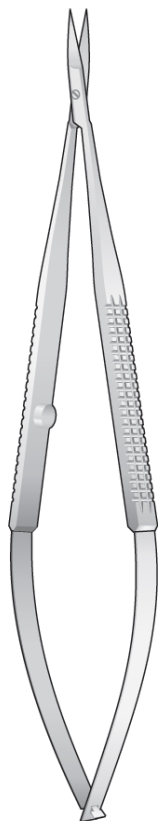
1/1 1/1
SSI-FD-137 SSI-FD-138
 150 mm 150 mm

SSI-FD-137/SSI-FD-138
 150 mm

Email: sheffieldsurgicalinstruments@gmail.com
 Web: www.sheffieldsurgicalinst.com

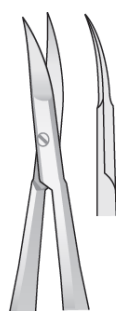


Scheren
Scissors
Forbici
Tijeras
Ciseaux



SSI-FD-182
160 mm

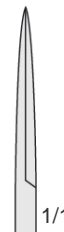
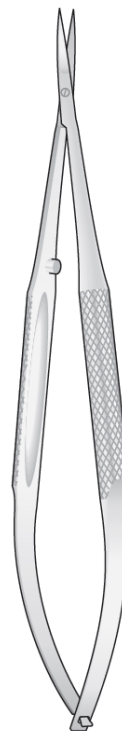
Spitz
Sharp
Acuta
Aguda
Pointu



SSI-FD-183
160 mm

Spitz
Sharp
Acuta
Aguda
Pointu

1/1



1/1

SSI-FD-224
145 mm
Spitz
Sharp
Acuta
Aguda
Pointu

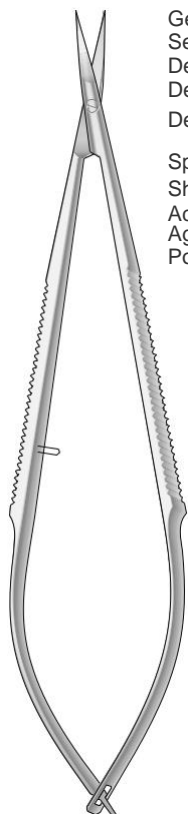


1/1

SSI-FD-225
145 mm
Spitz
Sharp
Acuta
Aguda
Pointu

SSI-FD-182/SSI-FD-183
160 mm

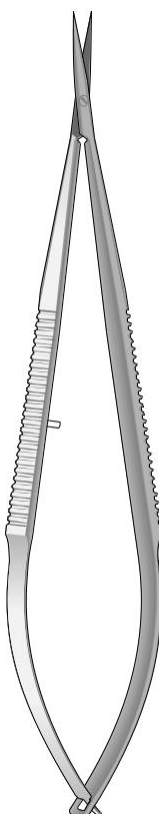
SSI-FD-224/SSI-FD-225
145 mm



Gezahnt
Serrated
Dentellata
Dentada
Dentelé

Spitz
Sharp
Acuta
Aguda
Pointu

SSI-FD-145
160 mm

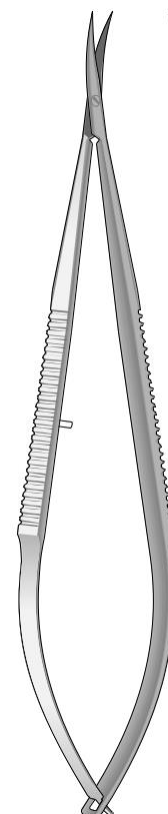


1/1

SSI-FD-06
160 mm

Spitz
Sharp
Acuta
Aguda
Pointu

SSI-FD-06
160 mm



1/1

SSI-FD-08
160 mm

Spitz
Sharp
Acuta
Aguda
Pointu

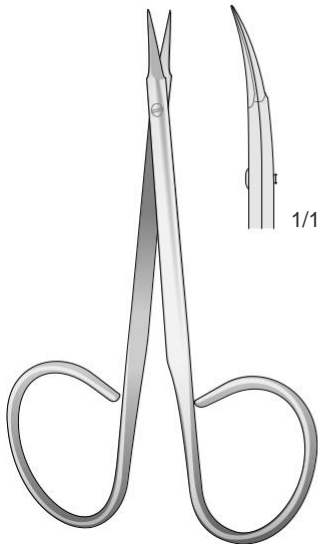
SSI-FD-08
160 mm

Email: sheffieldsurgicalinstruments@gmail.com
Web: www.sheffieldsurgicalinst.com



Scheren
Scissors
Forbici
Tijeras
Ciseaux

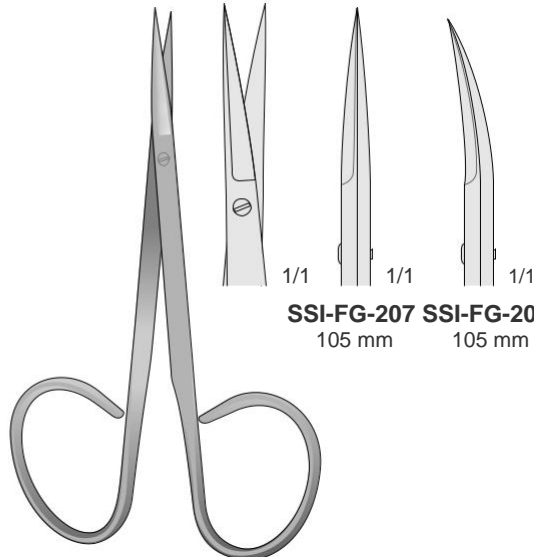
Spitz - Sharp
Acuta - Aguda
Pointu



STITCH
SSI-FG-216
115 mm

Iris Scheren - Iris scissors
Forbici Iris - Tijeras Iris

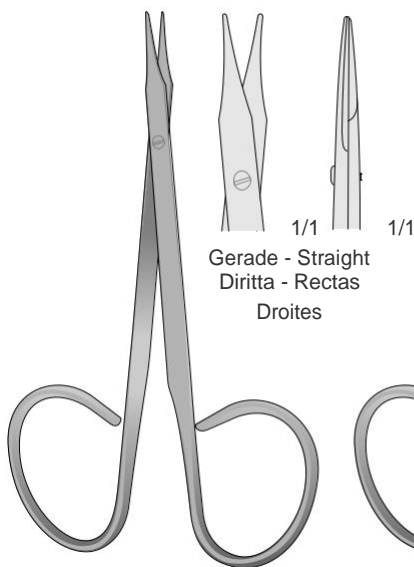
Ciseaux Iris



SSI-FG-207 SSI-FG-208
105 mm 105 mm

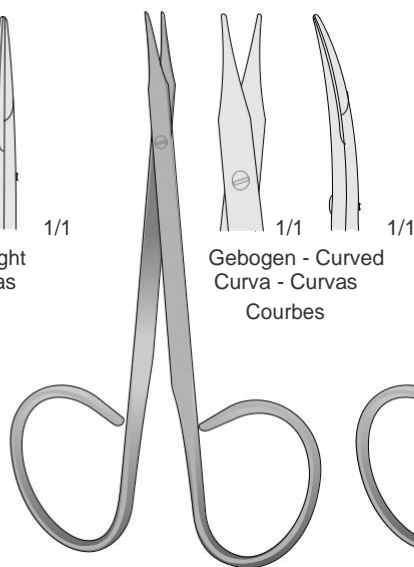
SSI-FG-207/SSI-FG-208
105 mm

Stumpf - Blunt
Smussa - Romas
Mousse



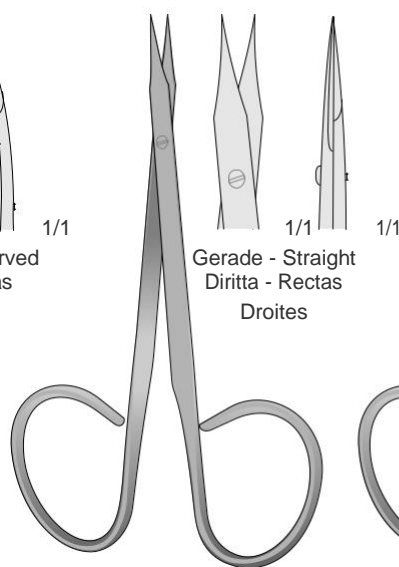
STEVENS
SSI-FG-209
100 mm

Stumpf - Blunt
Smussa - Romas
Mousse



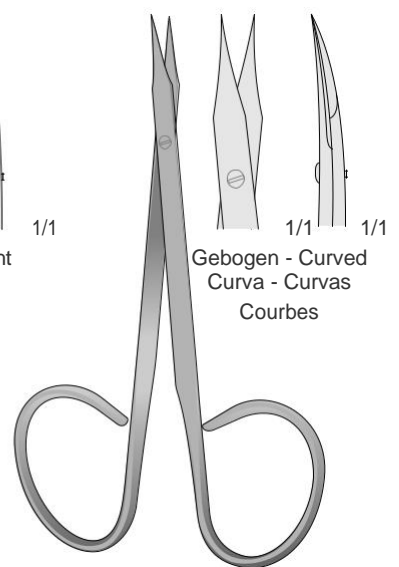
STEVENS
SSI-FG-210
100 mm

Spitz - Sharp
Acuta - Aguda
Pointu



WALTON
SSI-FG-211
100 mm

Spitz - Sharp
Acuta - Aguda
Pointu



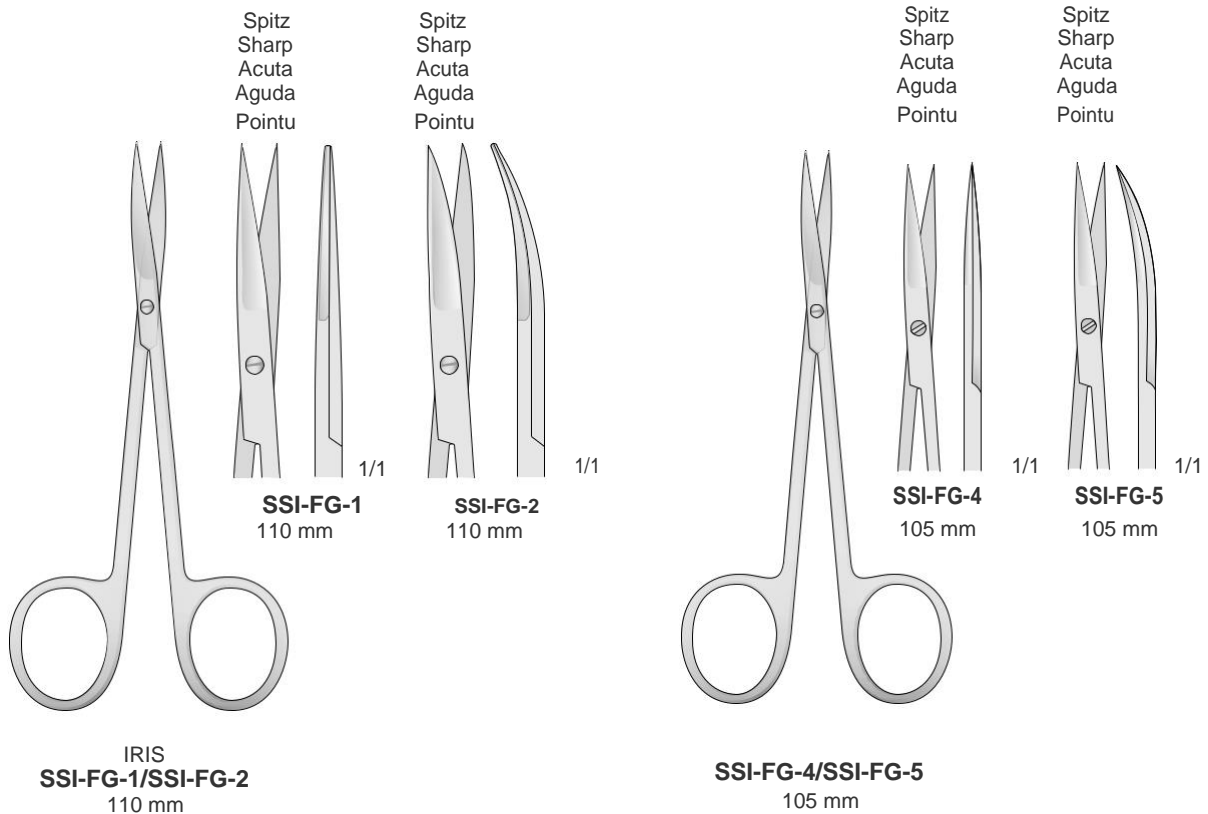
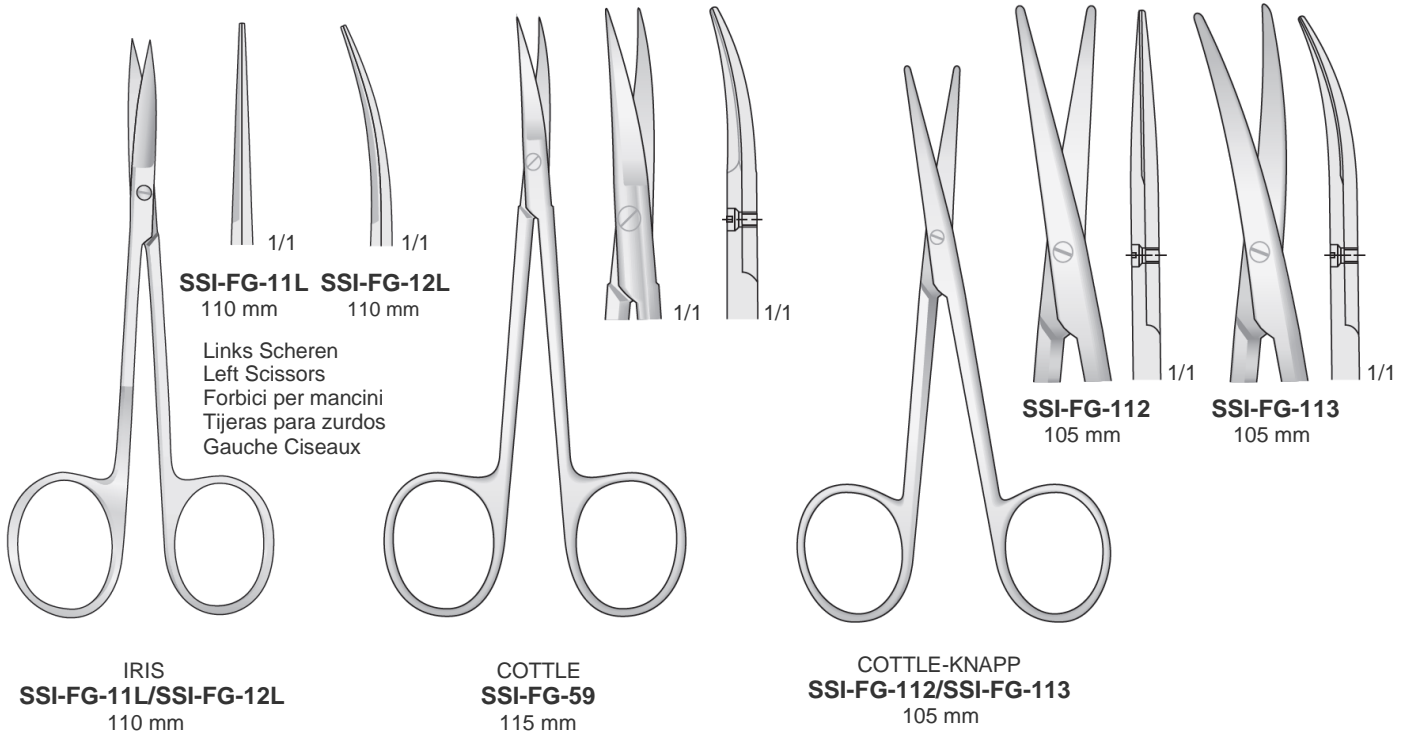
WALTON
SSI-FG-212
100 mm

Email: sheffieldsurgicalinstruments@gmail.com
Web: www.sheffieldsurgicalinst.com



Scheren
Scissors
Forbici
Tijeras
Ciseaux

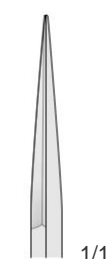
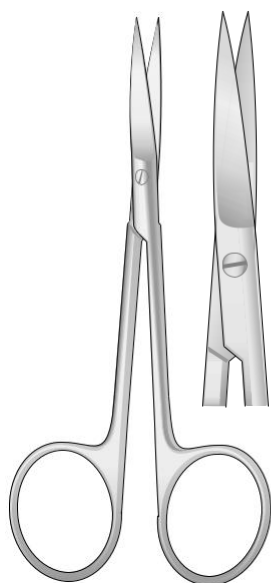
L = links
left
mancini
izquierdo
gauche



Email: sheffieldsurgicalinstruments@gmail.com
Web: www.sheffieldsurgicalinst.com

Scheren
Scissors
Forbici
Tijeras
Ciseaux

Gezant - Serrated
Dentellata - Dentelé - Dentadas



SSI-FG-156
110 mm

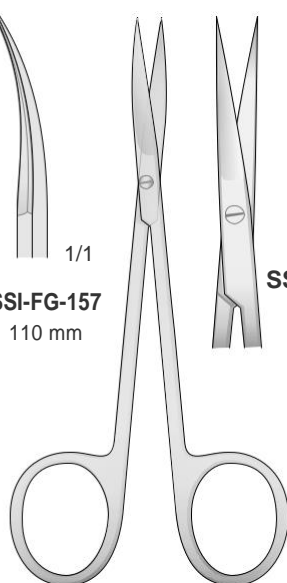


SSI-FG-157
110 mm

1/1

SSI-FG-156/SSI-FG-157
110 mm

Gezant - Serrated
Dentellata - Dentelé - Dentadas



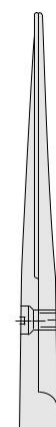
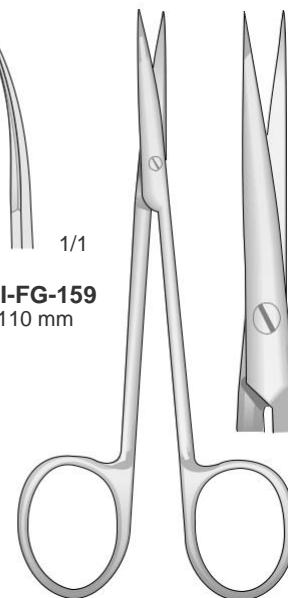
SSI-FG-158
110 mm



SSI-FG-159
110 mm

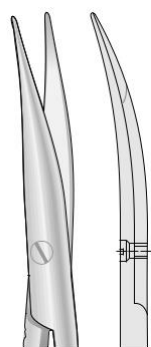
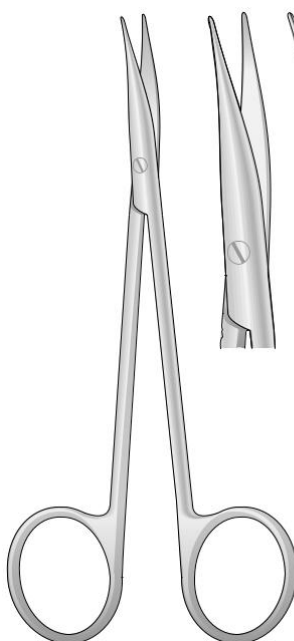
1/1

SSI-FG-158/SSI-FG-159
110 mm



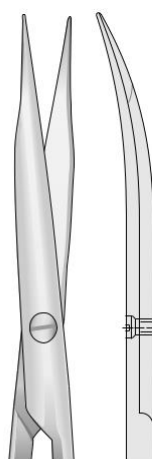
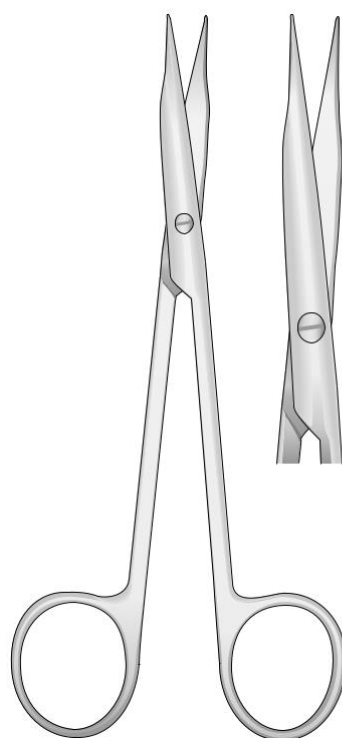
1/1

KILNER
SSI-FG-58
115 mm



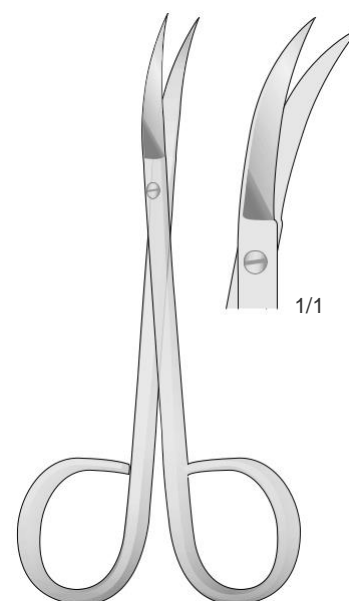
1/1

JAMESON-WERBER
SSI-FG-123
130 mm



1/1

JAMESON
SSI-FG-124
145 mm



1/1

SSI-FG-3
115 mm

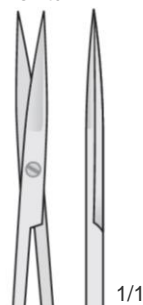
Email: sheffieldsurgicalinstruments@gmail.com
Web: www.sheffieldsurgicalinst.com



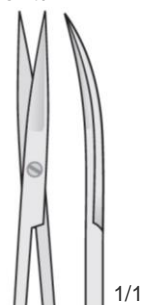
Scheren
Scissors
Forbici
Tijeras
Ciseaux

Spitz
Sharp
Acuta
Aguda
Pointu

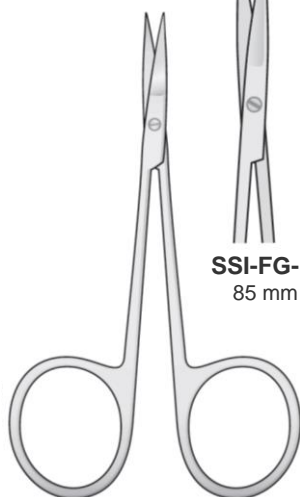
Spitz
Sharp
Acuta
Aguda
Pointu



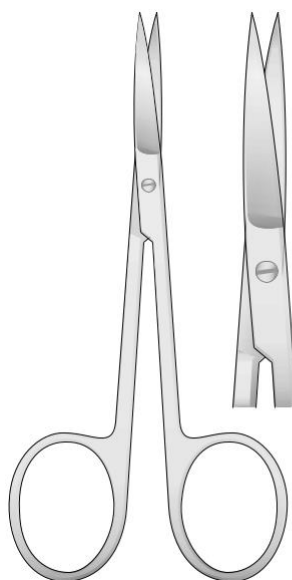
SSI-FG-13
85 mm



SSI-FG-15
85 mm



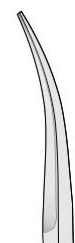
MICRO-IRIS
SSI-FG-13/SSI-FG-15
85 mm



SSI-FG-23/SSI-FG-24
110 mm

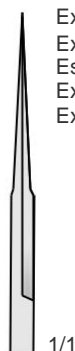


SSI-FG-23

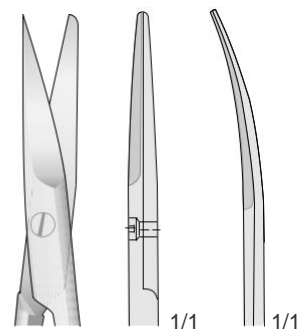
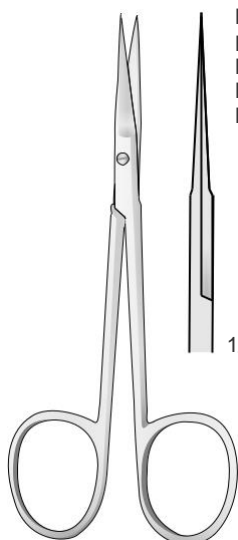


SSI-FG-24

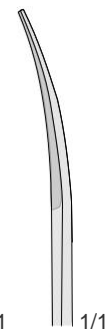
Extra flach
Extra flat
Estremamente piatta
Extra plano
Extrêmement plat



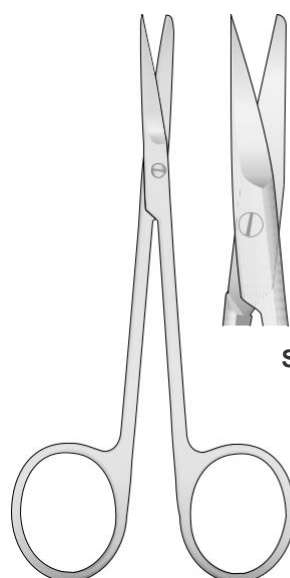
SSI-FG-104
100 mm



SSI-FG-103



SSI-FG-105



SSI-FG-103/SSI-FG-105
110 mm

Email: sheffieldsurgicalinstruments@gmail.com
Web: www.sheffieldsurgicalinst.com



Scheren
Scissors
Forbici
Tijeras
Ciseaux

Spitz - Sharp
Acuta - Agudo
Aigu

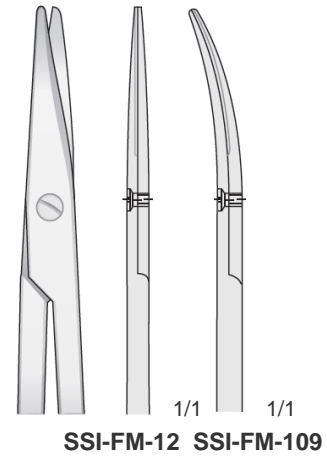
Spitz - Sharp
Acuta - Agudo
Aigu



SSI-FM-126

SSI-FM-127

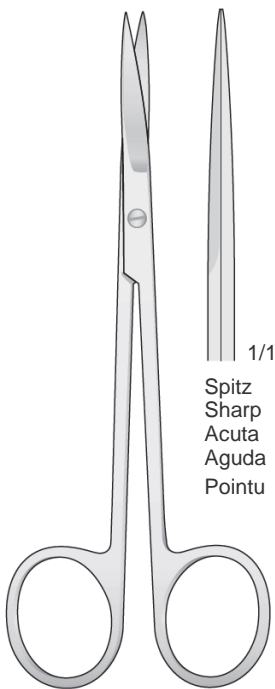
METZENBAUM
SSI-FM-126/SSI-FM-127
145 mm



SSI-FM-12 SSI-FM-109

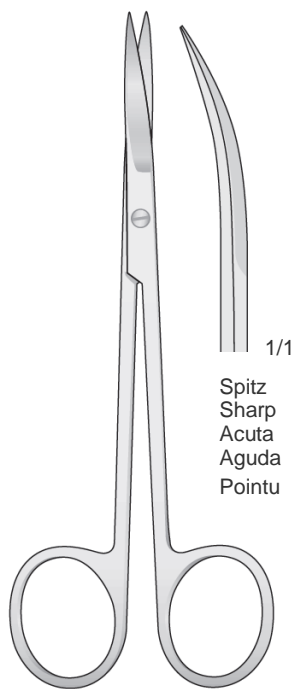


METZENBAUM
SSI-FM-12/SSI-FM-109
150 mm



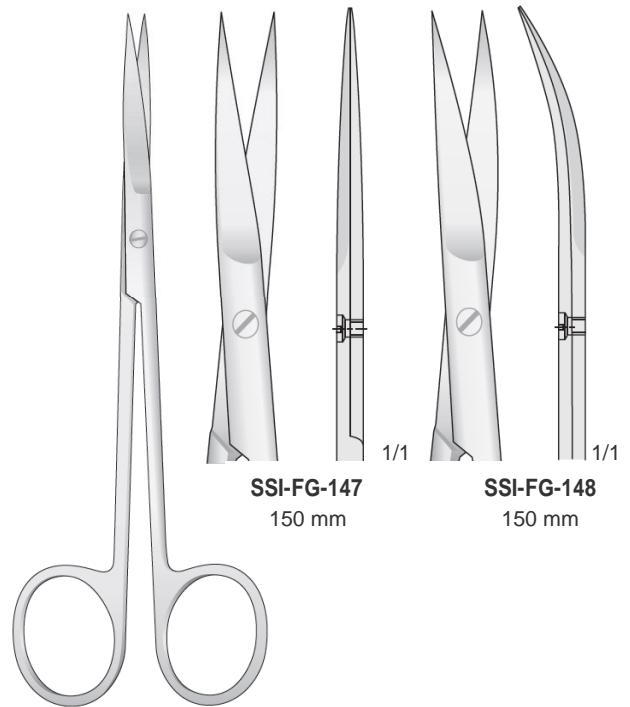
1/1
Spitz
Sharp
Acuta
Aguda
Pointu

METZENBAUM
SSI-FG-28
145 mm



1/1
Spitz
Sharp
Acuta
Aguda
Pointu

METZENBAUM
SSI-FG-14
145 mm



SSI-FG-147
150 mm

SSI-FG-148
150 mm

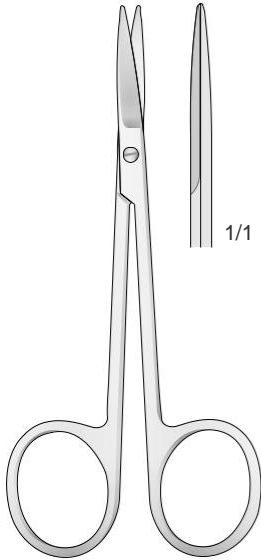
JOSEPH
SSI-FG-147/SSI-FG-148
150 mm

Email: sheffieldsurgicalinstruments@gmail.com
Web: www.sheffieldsurgicalinst.com



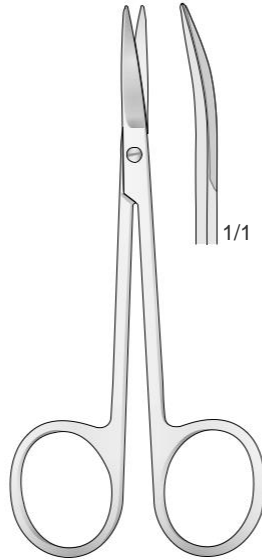
Scheren
Scissors
Forbici
Tijeras
Ciseaux

Stumpf
Blunt
Smussa
Romas
Mousse



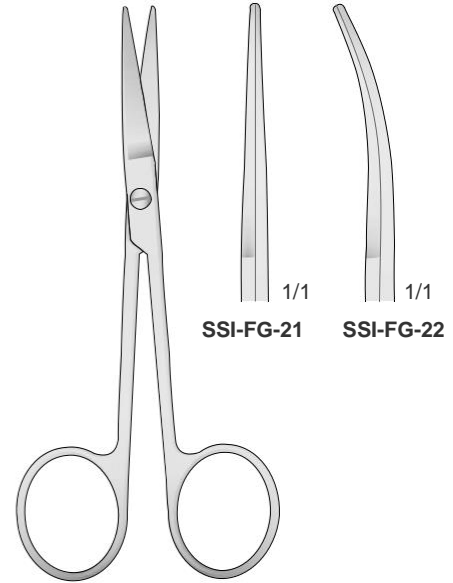
SSI-FG-101
110 mm

Stumpf
Blunt
Smussa
Romas
Mousse



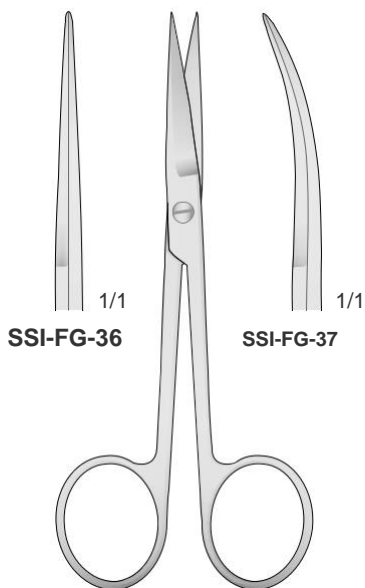
SSI-FG-102
110 mm

Stumpf
Blunt
Smussa
Romas
Mousse

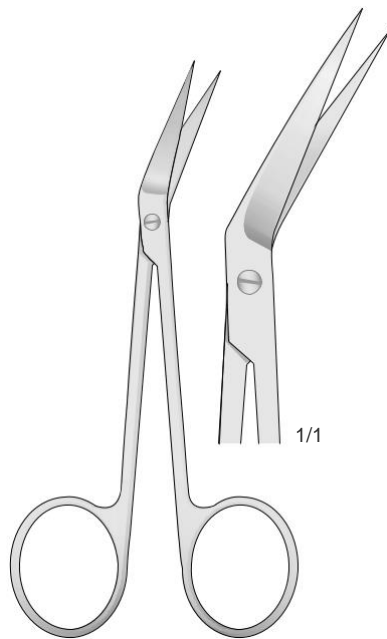


SSI-FG-21/SSI-FG-22
115 mm

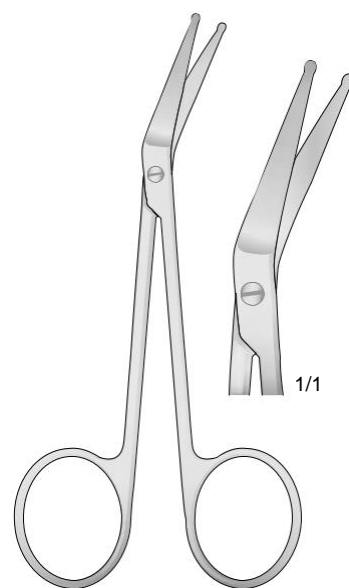
Spitz
Sharp
Acute
Agudas
Pointu



SSI-FG-36/SSI-FG-37
115 mm



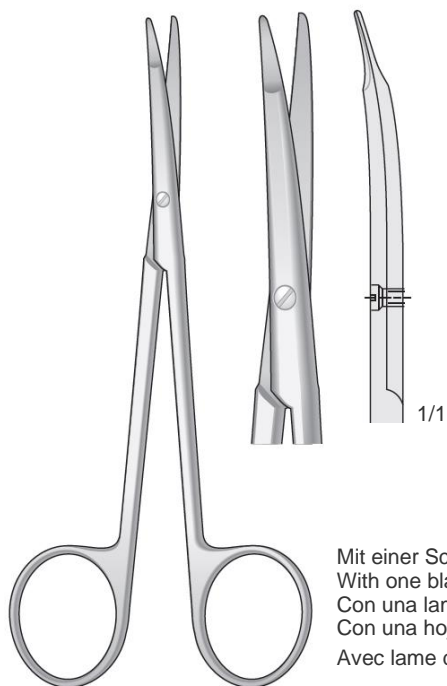
LOCKLIN
SSI-LK-1
115 mm



LOCKLIN MOD.
SSI-LK-3
110 mm

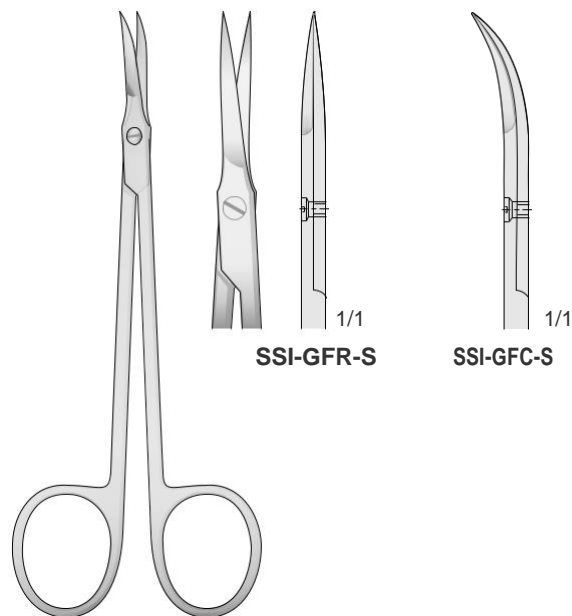
Email: sheffieldsurgicalinstruments@gmail.com
Web: www.sheffieldsurgicalinst.com

Scheren
Scissors
Forbici
Tijeras
Ciseaux



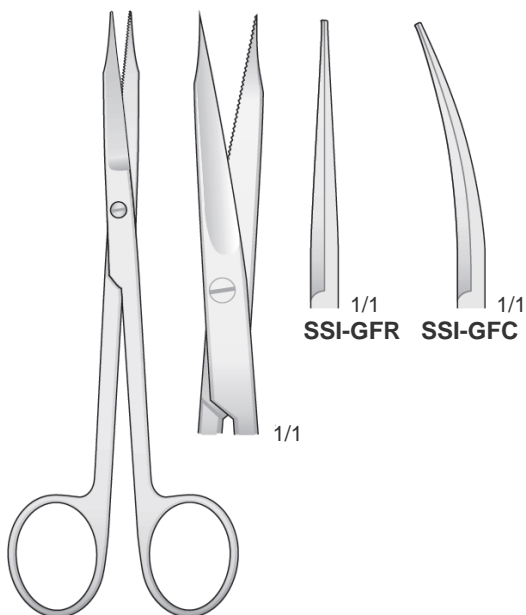
KILNER
SSI-FG-121
130 mm

Mit einer Schneide gezahnt
With one blade serrated
Con una lama zigrinata
Con una hoja dentada
Avec lame dentelé



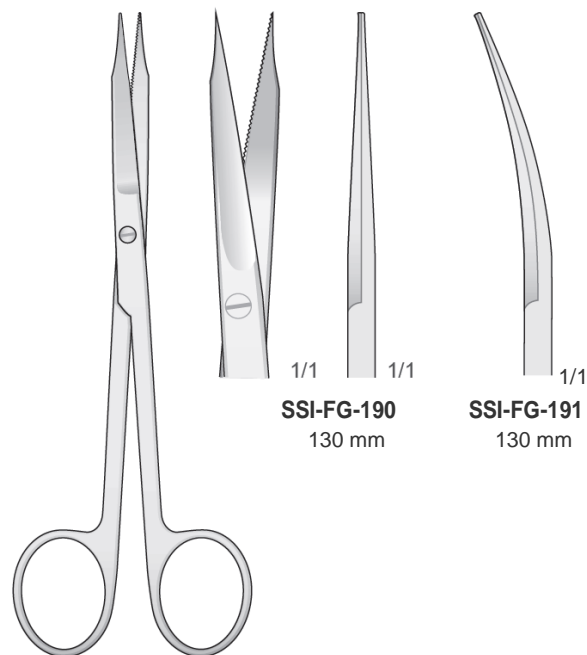
SSI-GFR-S/SSI-GFC-S
120 mm

Gezahnt - Serrated
Dentellata - Dentadas
Dentelé



GOLDMAN-FOX
GFR/GFC
120 mm

Gezahnt - Serrated
Dentellata - Dentadas
Dentelé



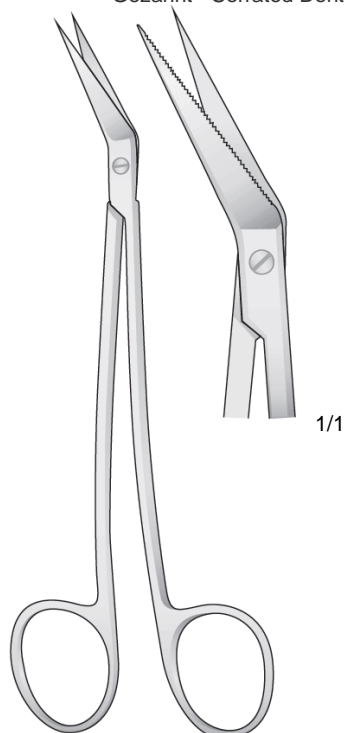
GOLDMAN-FOX
SSI-FG-190/SSI-FG-191
130 mm

Email: sheffieldsurgicalinstruments@gmail.com
Web: www.sheffieldsurgicalinst.com

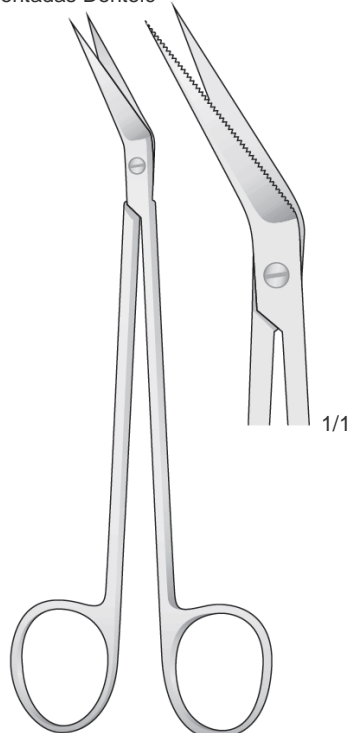


Scheren
Scissors
Forbici
Tijeras
Ciseaux

Gezahnt - Serrated Dentellata - Dentadas Dentelé

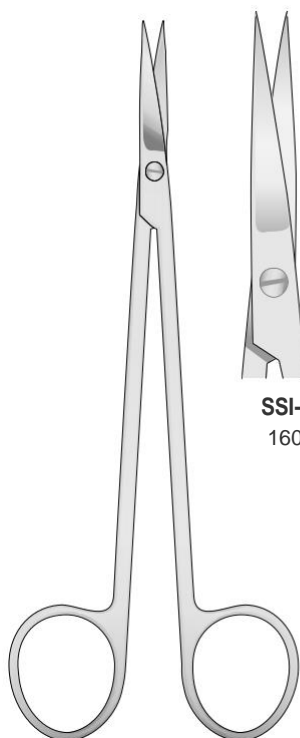


LOCKLIN
SSI-LK-2
160 mm

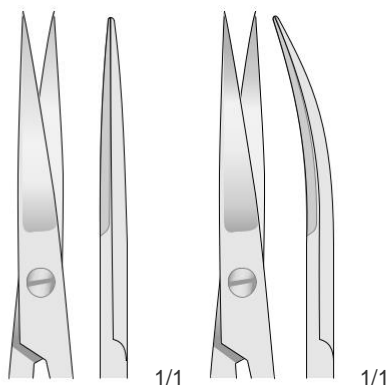


LOCKLIN
SSI-LK-4
160 mm

Gezahnt - Serrated
Dentellata - Dentadas
Dentelé

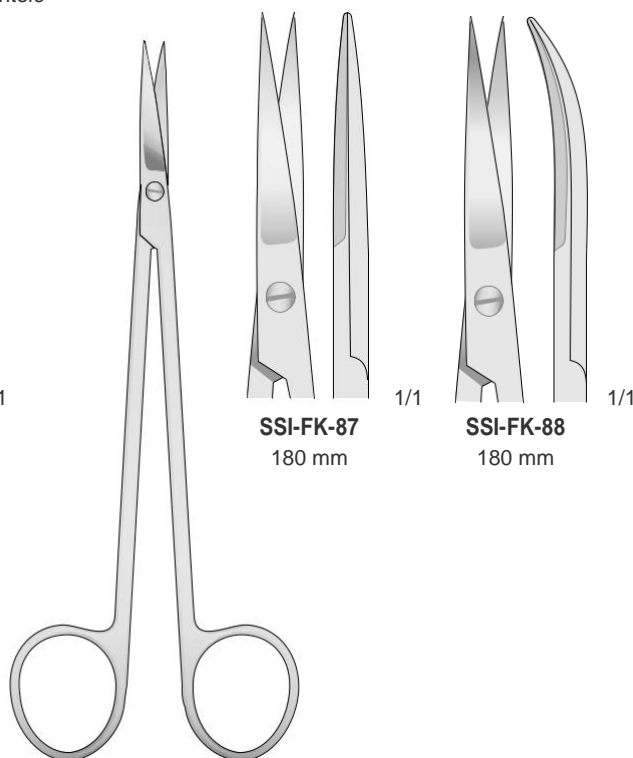


KELLY
SSI-FK-1 / SSI-FK-2
160 mm

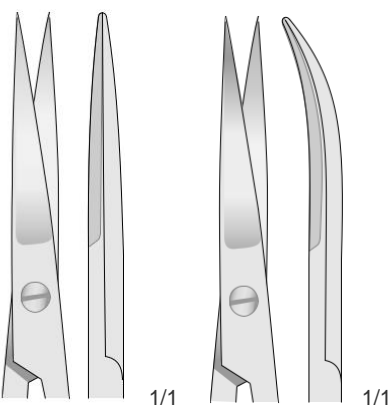


SSI-FK-1
160 mm

SSI-FK-2
160 mm



KELLY
SSI-FK-87 / SSI-FK-88
180 mm

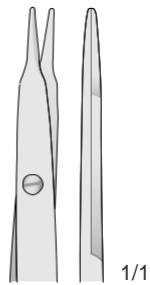
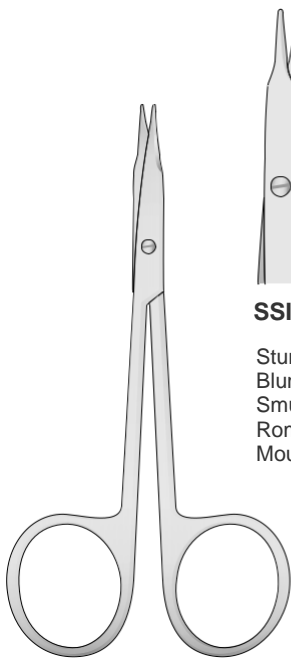


SSI-FK-87
180 mm

SSI-FK-88
180 mm

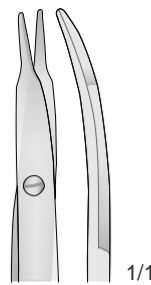
Email: sheffieldsurgicalinstruments@gmail.com
Web: www.sheffieldsurgicalinst.com

Scheren
Scissors
Forbici
Tijeras
Ciseaux



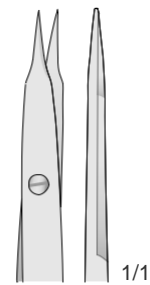
SSI-FG-50

Stumpf Gerade
Blunt Straight
Smussa Diritta
Romas Rectas
Mousse Droites



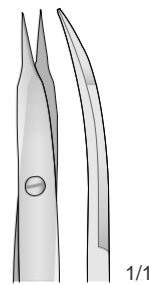
SSI-FG-51

Stumpf Gebogen
Blunt Curved
Smussa Curva
Romas Curvas
Mousse Courbes



SSI-FG-52

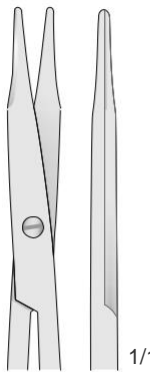
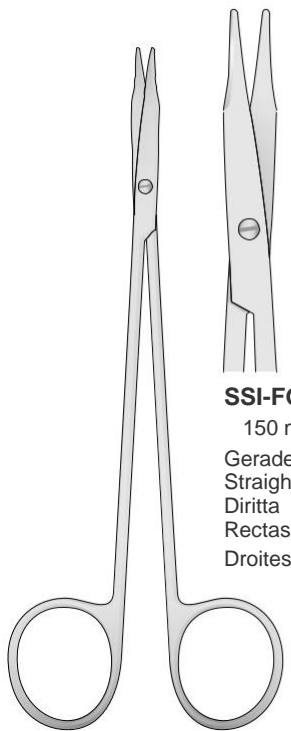
Spitz Gerade
Sharp Straight
Acuta Diritta
Agudas Rectas
Pointu Droites



SSI-FG-53

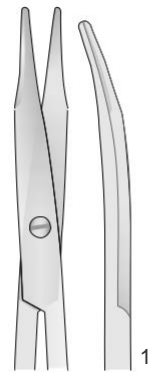
Spitz Gebogen
Sharp Curved
Acuta Curva
Agudas Curvas
Pointu Courbes

STEVENS
SSI-FG-50/SSI-FG-53
110 mm



SSI-FG-54

150 mm
Gerade
Straight
Diritta
Rectas
Droites

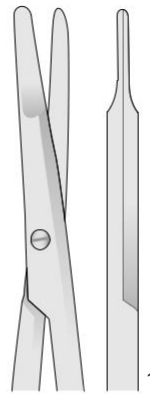
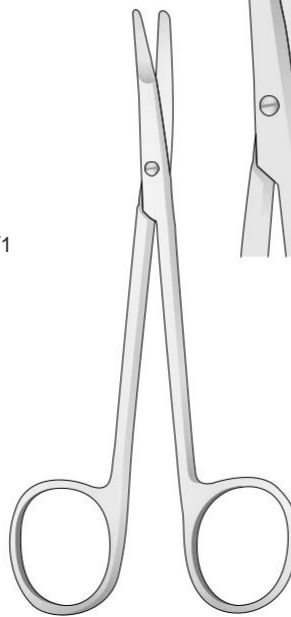


SSI-FG-55

150 mm
Gebogen
Curved
Curva
Curvas
Courbes

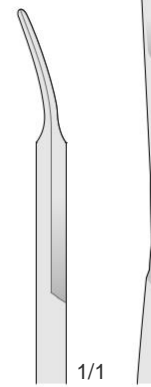
Stumpf
Blunt
Smussa
Romas
Mousse

REYNOLDS
SSI-FG-54/SSI-FG-55



SSI-FG-66

120 mm
Gerade
Straight
Diritta
Rectas
Droites

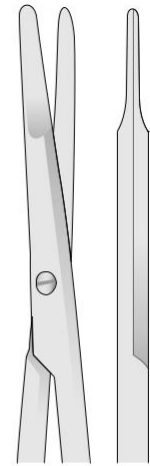


SSI-FG-67

120 mm
Gebogen
Curved
Curva
Curvas
Courbes

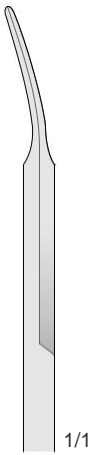
Stumpf
Blunt
Smussa
Romas
Mousse

KILNER
SSI-FG-19C/SSI-FG-67



SSI-FG-19R

135 mm
Gerade
Straight
Diritta
Rectas
Droites



SSI-FG-19C

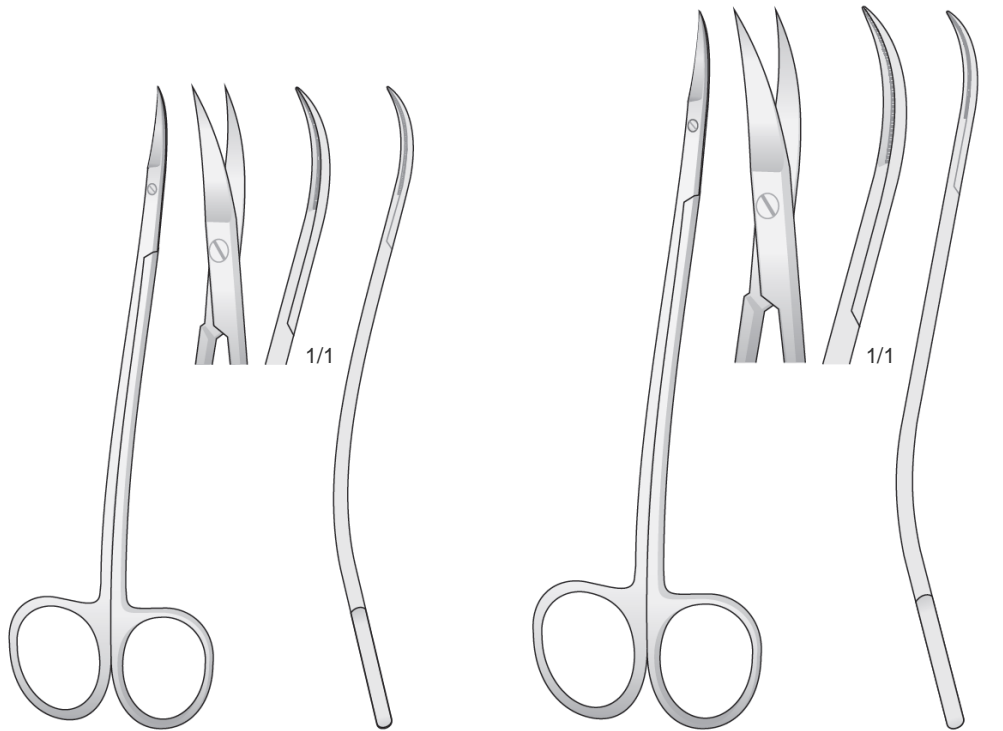
135 mm
Gebogen
Curved
Curva
Curvas
Courbes

Email: sheffieldsurgicalinstruments@gmail.com
Web: www.sheffieldsurgicalinst.com



Scheren
Scissors
Forbici
Tijeras
Ciseaux

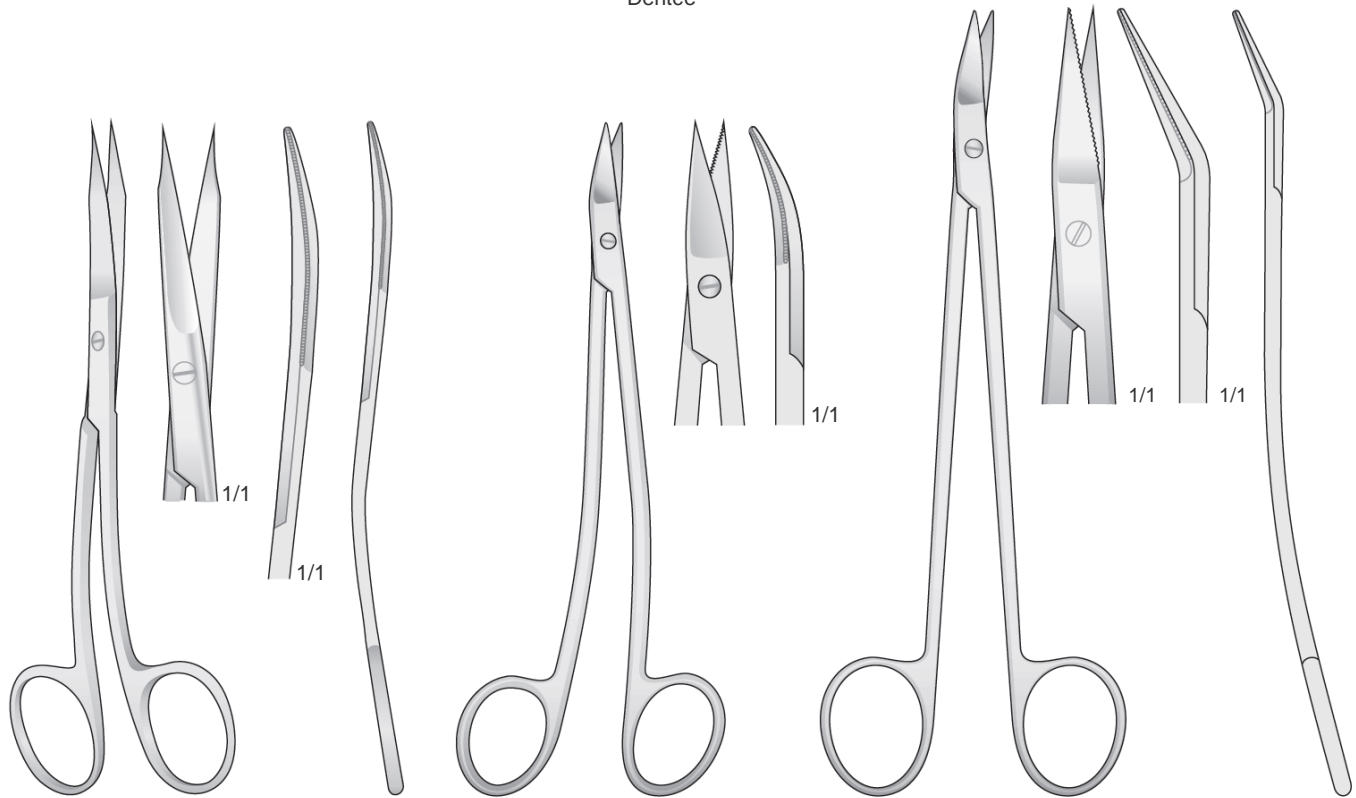
Gezahnt - Serrated
Dentellata - Dentadas
Dentelé



LA GRANGE
SSI-LG-1
115 mm

LA GRANGE
SSI-LG-6
155 mm

Gezahnt - Serrated
Dentellata - Dentada
Dentée



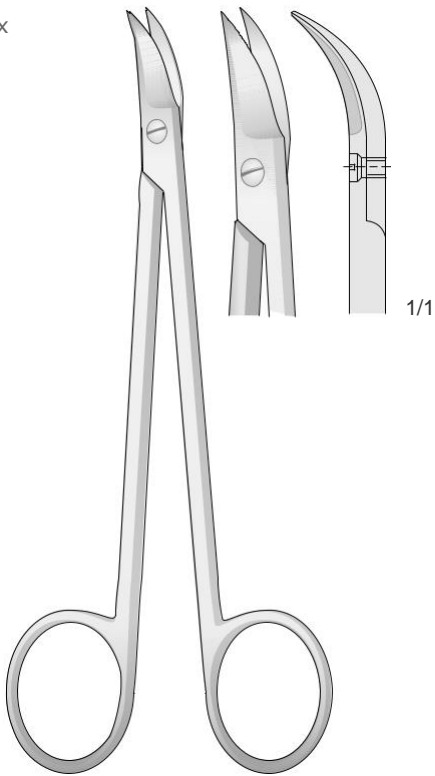
GOLDMAN-FOX S FORM
GFS
130 mm

NEUMANN
SSI-FG-20
130 mm

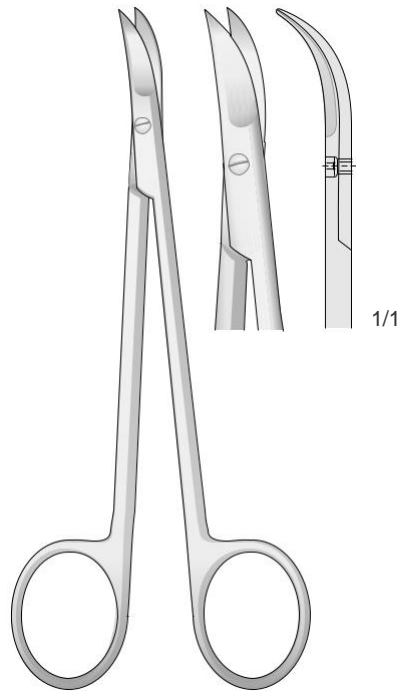
DEAN
DEAN
180 mm

Email: sheffieldsurgicalinstruments@gmail.com
Web: www.sheffieldsurgicalinst.com

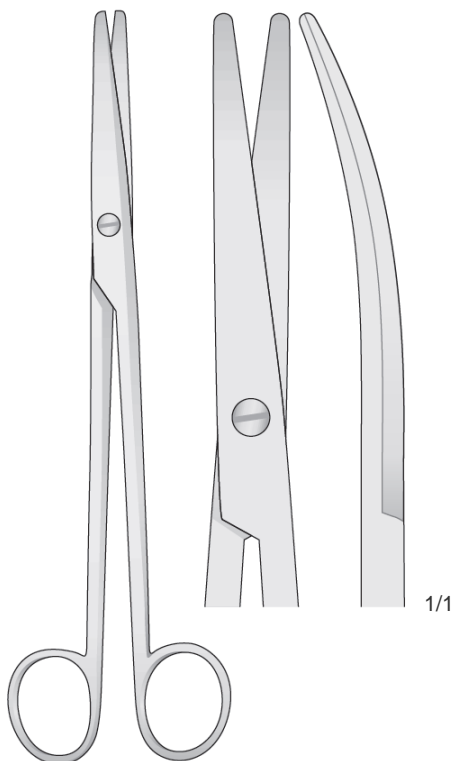
Scheren
Scissors
Forbici
Tijeras
Ciseaux



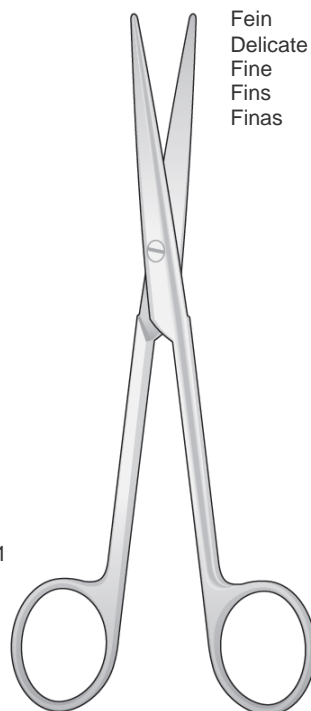
QUINBY
SSI-FG-38
130 mm



CHADWICK
SSI-FG-39
115 mm

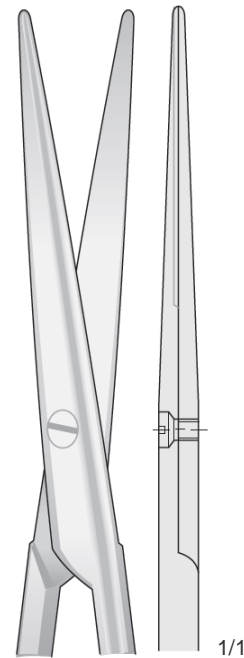


MAYO-LEXER
SSI-FM-79
165 mm

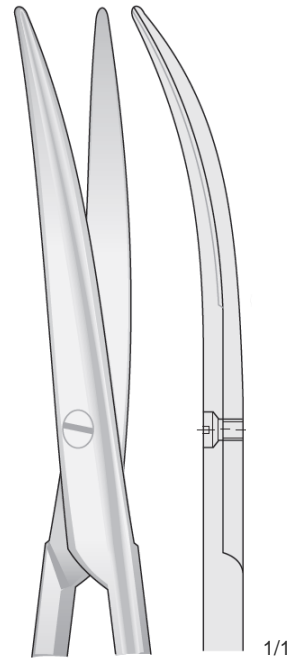


LEXER
SSI-FM-180/SSI-FM-181
165 mm

Fein
Delicate
Fine
Fins
Finas



SSI-FM-180



SSI-FM-181



Scheren
Scissors
Forbici
Tijeras
Ciseaux

Stumpf
Blunt
Smusse
Romas
Mousses

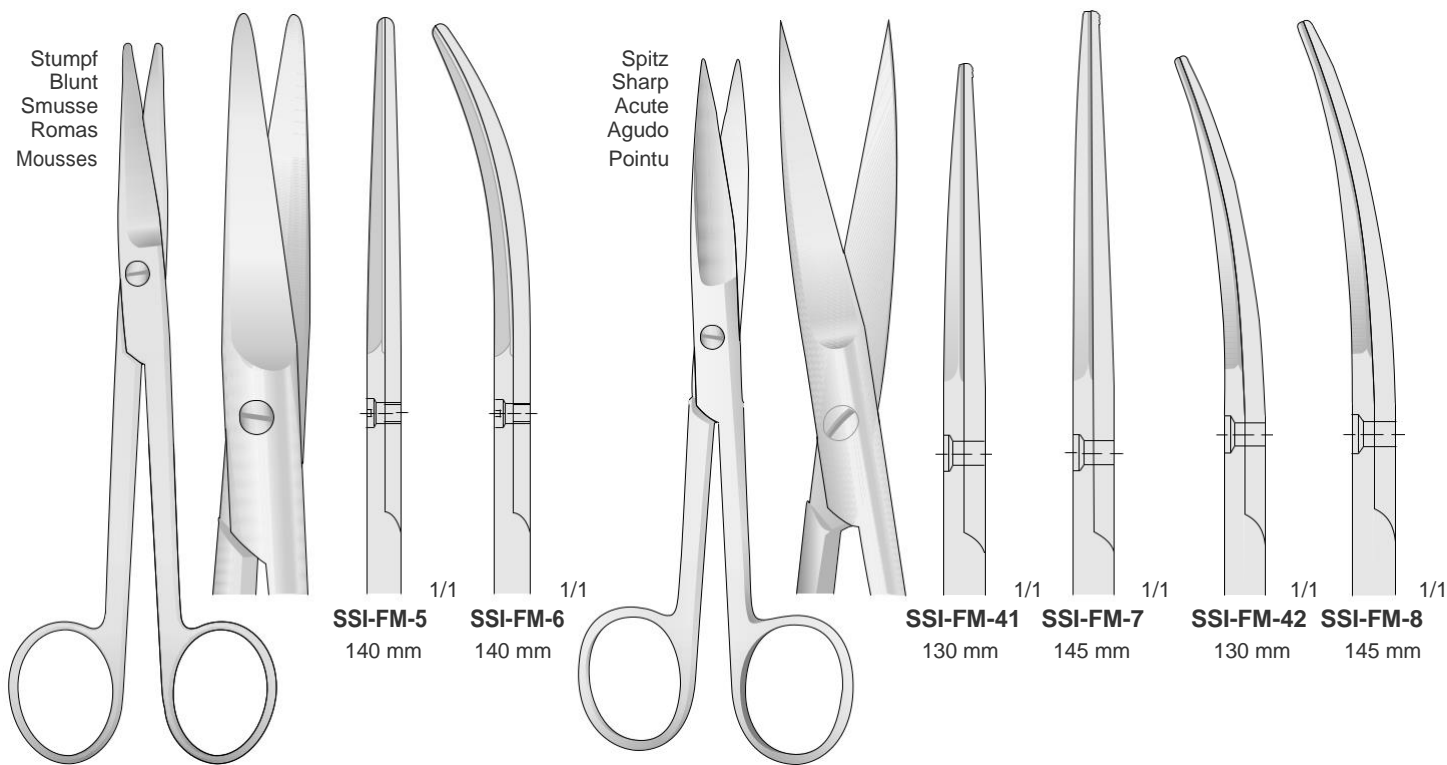


SSI-FM-9/SSI-FM-10
145 mm

SSI-FM-27/SSI-FM-63

Stumpf
Blunt
Smusse
Romas
Mousses

Spitz
Sharp
Acute
Agudo
Pointu



MAYO
SSI-FM-5/SSI-FM-6
140 mm

SSI-FM-7/SSI-FM-42

Email: sheffieldsurgicalinstruments@gmail.com
Web: www.sheffieldsurgicalinst.com

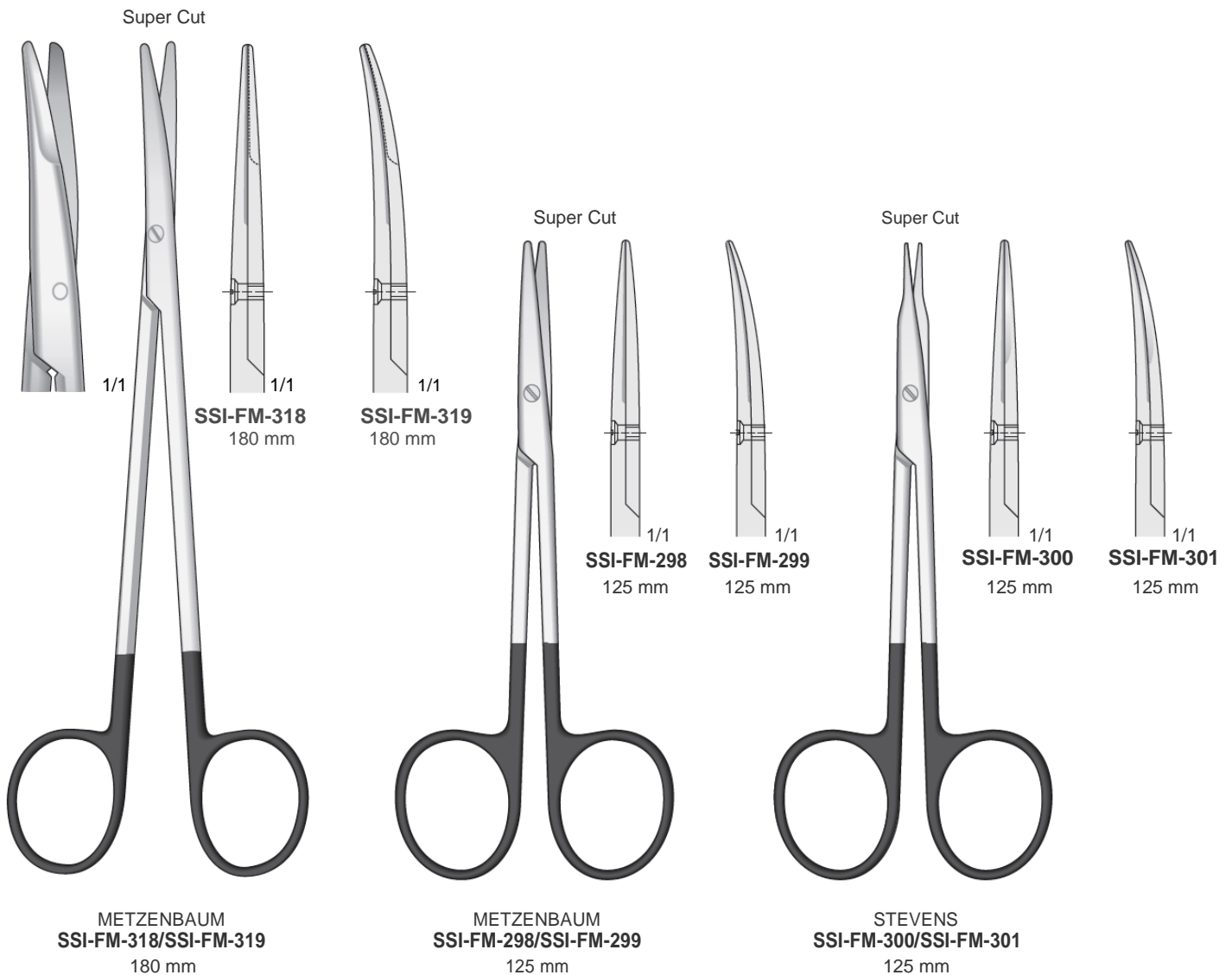
SUPER CUT



Super Cut Scissors have specially designed cutting edges.
One regular edge and **one sharp-knife edge.**

Extremely Sharp Razor Edge / Atraumatic
Extrem Scharfe Spitzer Beck / Atraumatische
Tranchant extrêmement aiguisée / Atraumatique
Borde extremadamente a lado / Atraumática
Taglio estremamente a lato / Atraumatica

One side serrated
Eine Seite gezahnt
Un côté dentelé
Un lado dentado
Un lato dentellato

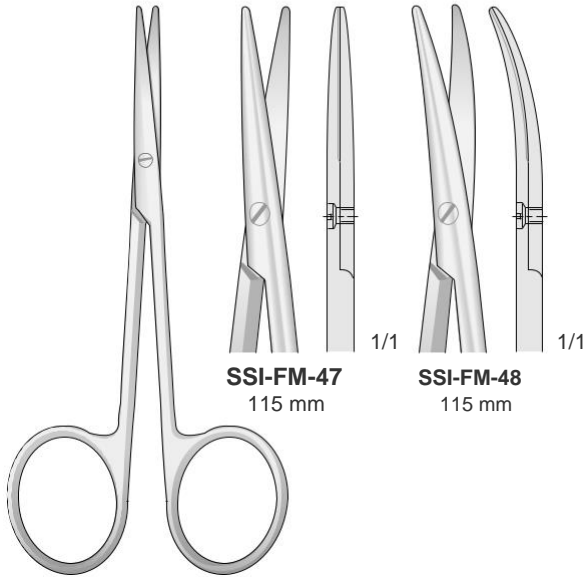


Email: sheffieldsurgicalinstruments@gmail.com
Web: www.sheffieldsurgicalinst.com



Scheren
Scissors
Forbici
Tijeras
Ciseaux

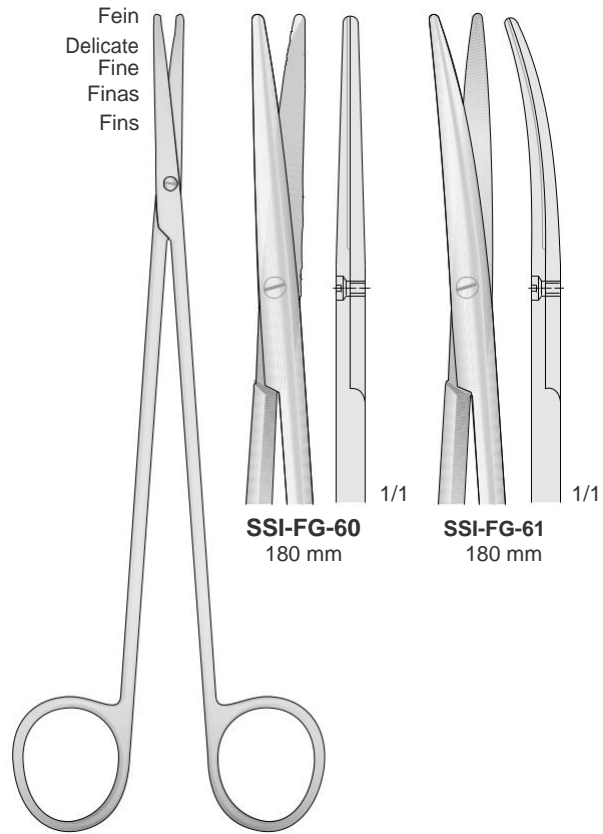
Fein
Delicate
Fine
Finas
Fins



SSI-FM-47
115 mm

SSI-FM-48
115 mm

BABY - METZENBAUM
SSI-FM-47/SSI-FM-48
115 mm

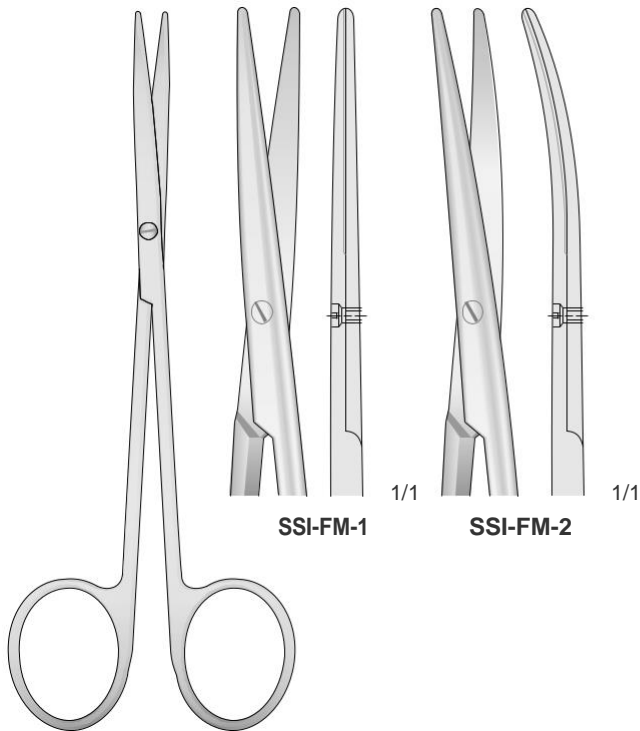


SSI-FG-60
180 mm

SSI-FG-61
180 mm

TOENNIS-ADSON
SSI-FG-60/SSI-FG-61
180 mm

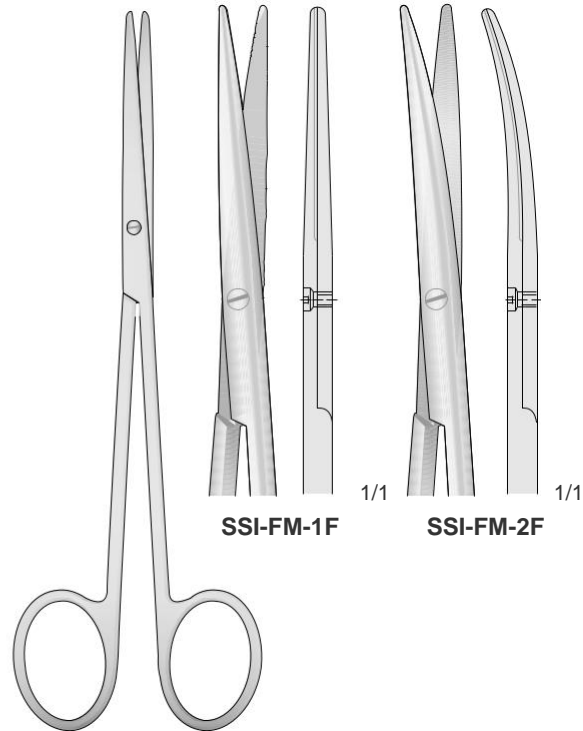
Präparierscheren - Dissecting Scissors
Forbici per dissezione - Tijeras de disección - Ciseaux à dissection



SSI-FM-1

SSI-FM-2

METZENBAUM
SSI-FM-1/SSI-FM-2
145 mm



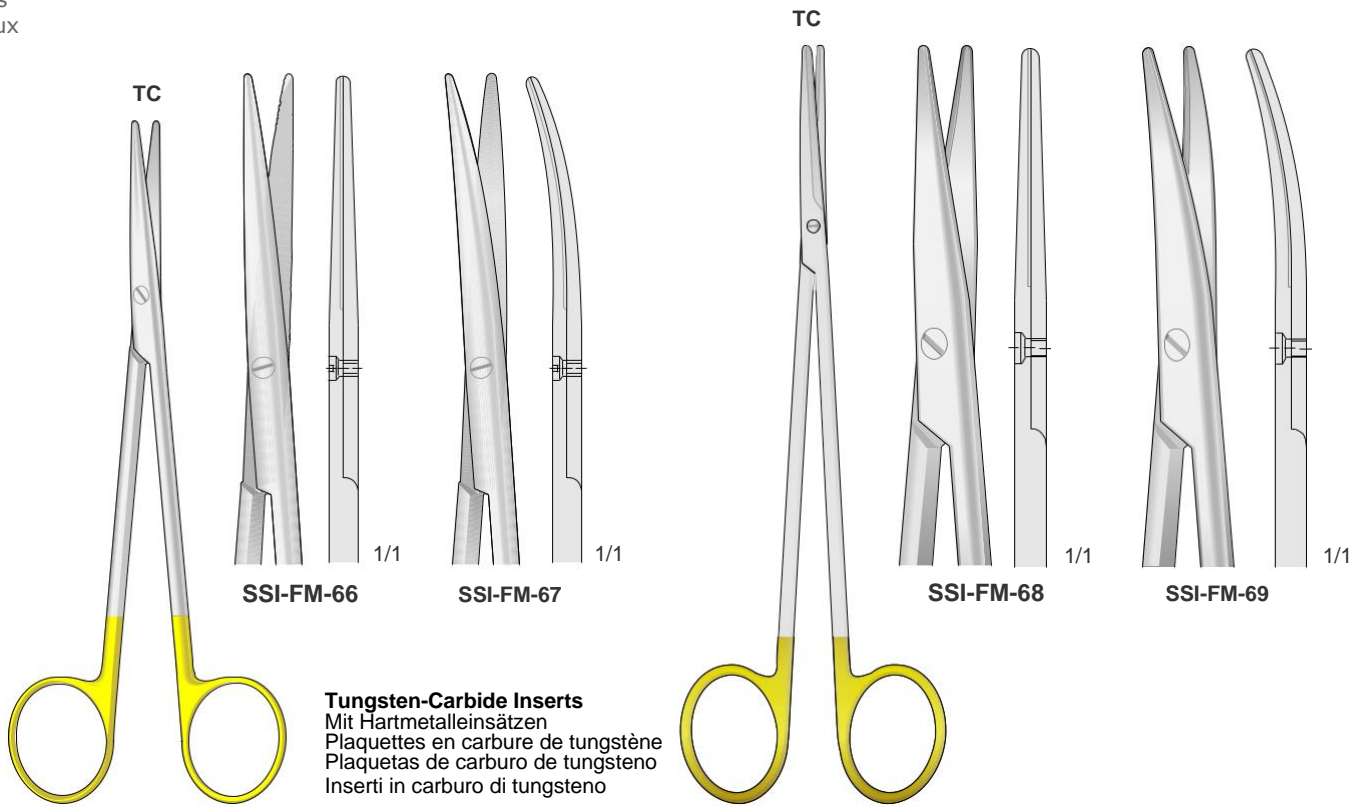
SSI-FM-1F

SSI-FM-2F

METZENBAUM-FINO
SSI-FM-1F/SSI-FM-2F
145 mm

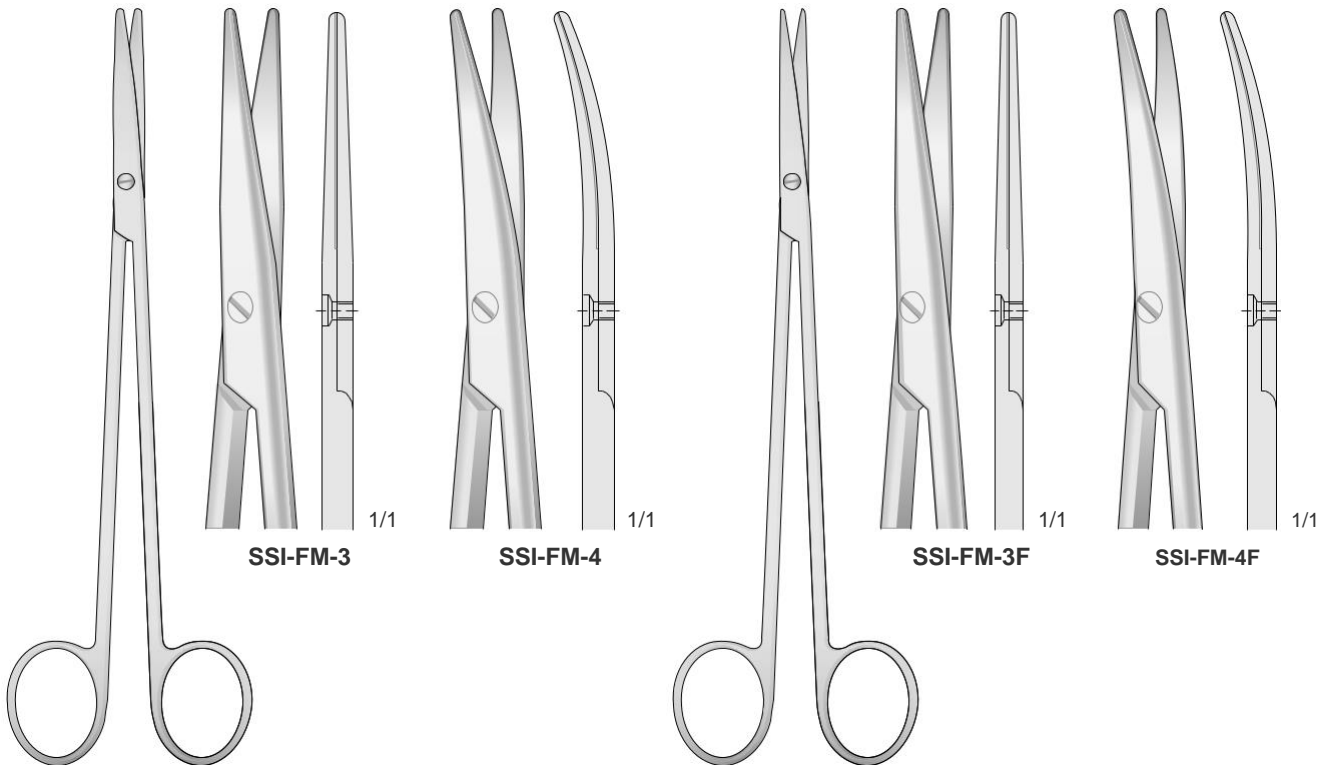
Email: sheffieldsurgicalinstruments@gmail.com
Web: www.sheffieldsurgicalinst.com

Scheren
Scissors
Forbici
Tijeras
Ciseaux



METZENBAUM
SSI-FM-66/SSI-FM-67
145 mm

METZENBAUM
SSI-FM-68/SSI-FM-69
185 mm



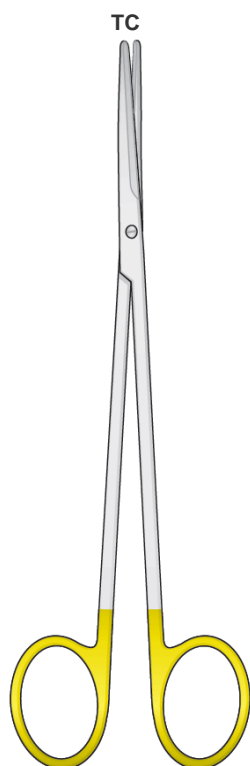
METZENBAUM
SSI-FM-3/SSI-FM-4
185 mm

METZENBAUM-FINO
SSI-FM-3F/SSI-FM-4F
185 mm

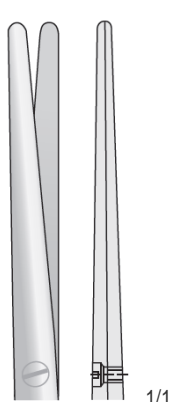
Email: sheffieldsurgicalinstruments@gmail.com
Web: www.sheffieldsurgicalinst.com



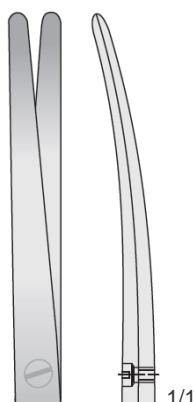
Scheren
Scissors
Forbici
Tijeras
Ciseaux



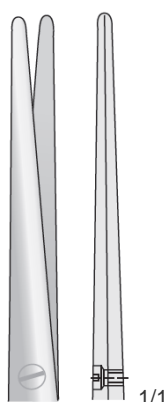
METZENBAUM-FINO
SSI-FM-201/SSI-FM-204



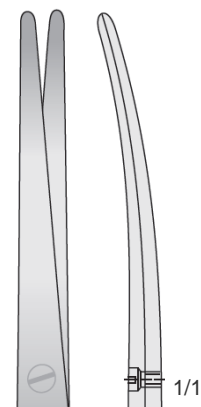
SSI-FM-201
140 mm



SSI-FM-202
140 mm

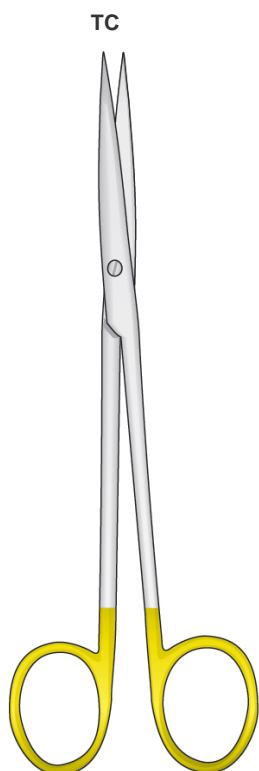


SSI-FM-203
180 mm

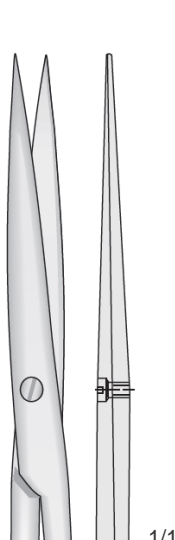


SSI-FM-204
180 mm

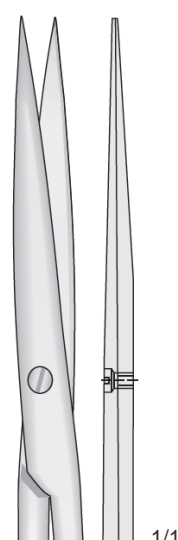
Tungsten-Carbide Inserts
Mit Hartmetalleinsätzen
Plaquettes en carbure de tungstène
Plaquetas de carburo de tungsteno
Inserti in carburo di tungsteno



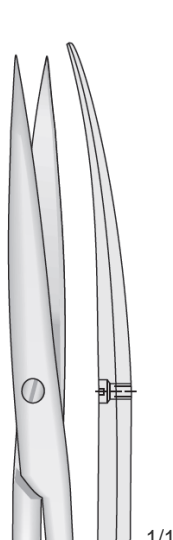
METZENBAUM-FINO
SSI-FM-96/SSI-FM-99



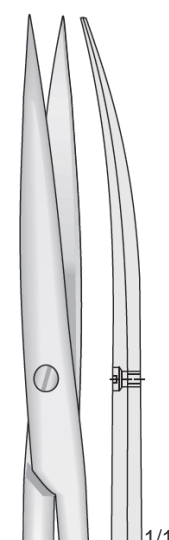
SSI-FM-96
140 mm



SSI-FM-97
180 mm



SSI-FM-98
140 mm

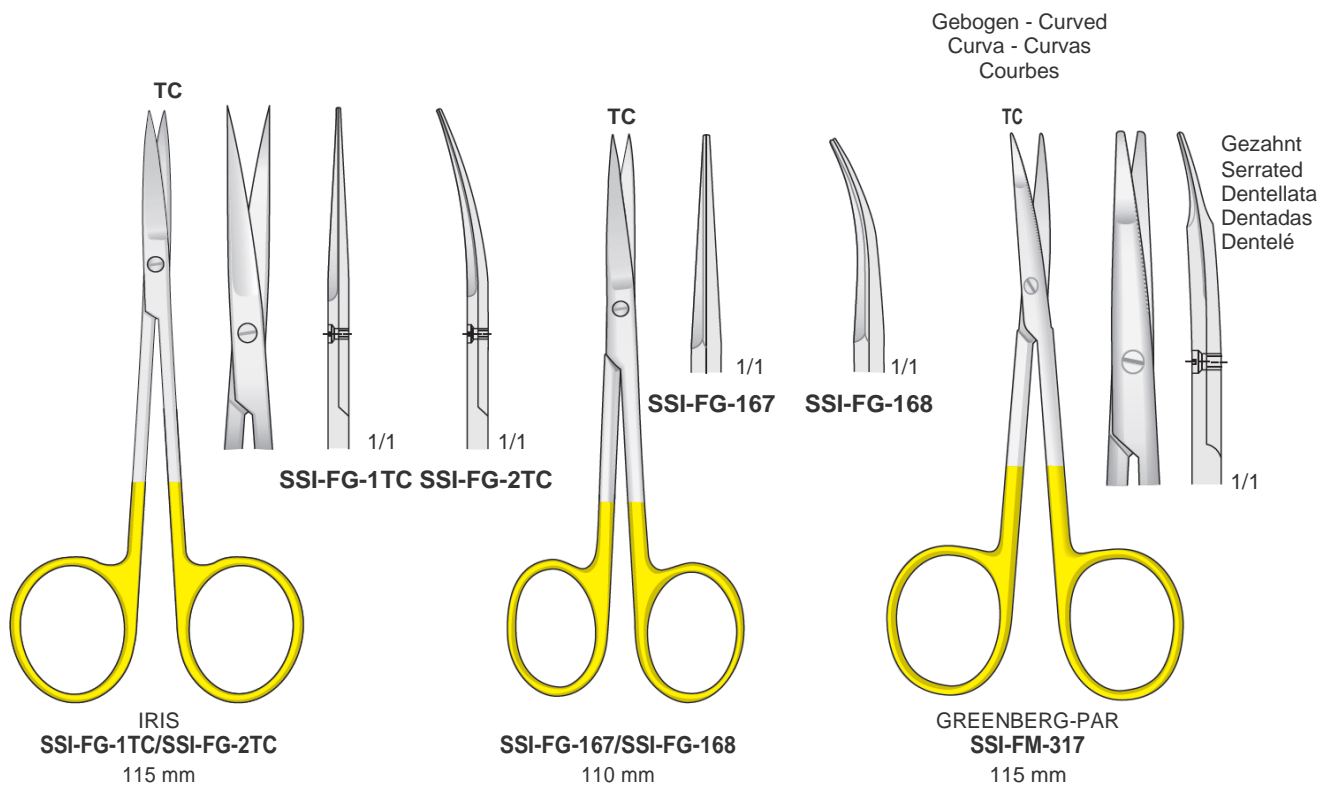
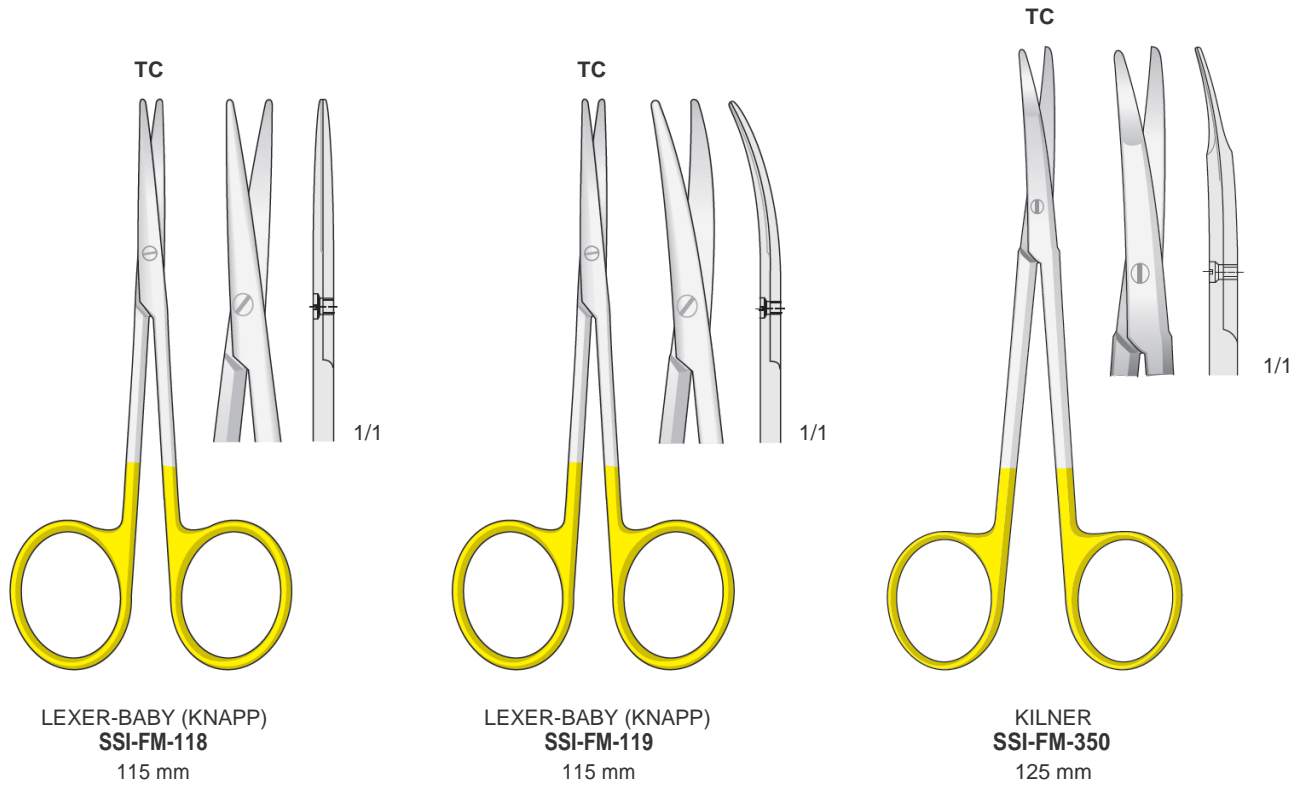


SSI-FM-99
180 mm

Email: sheffieldsurgicalinstruments@gmail.com
Web: www.sheffieldsurgicalinst.com

Scheren
Scissors
Forbici
Tijeras
Ciseaux

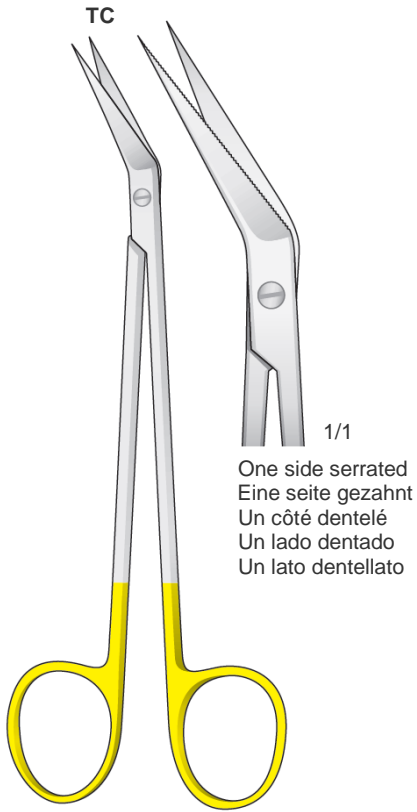
Tungsten-Carbide Inserts
Mit Hartmetalleinsätzen
Plaquettes en carbure de tungstène
Plaquetas de carburo de tungsteno
Inserti in carburo di tungsteno



Email: sheffieldsurgicalinstruments@gmail.com
Web: www.sheffieldsurgicalinst.com



Scheren
Scissors
Forbici
Tijeras
Ciseaux

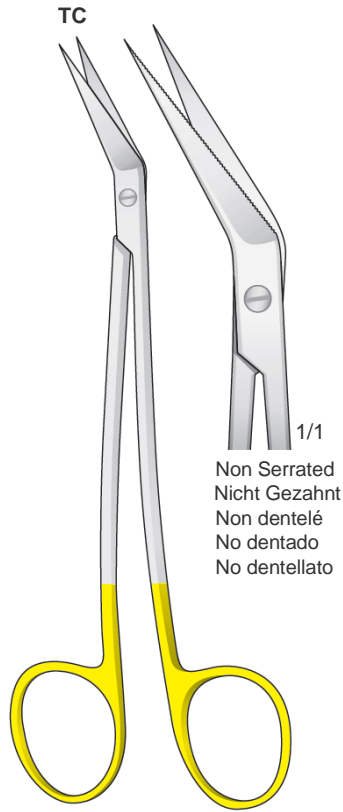


TC

1/1

One side serrated
Eine seite gezahnt
Un côté dentelé
Un lado dentado
Un lato dentellato

SSI-LK-10
160 mm



TC

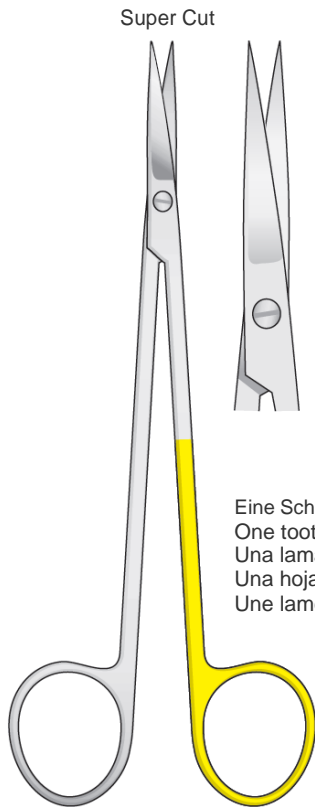
1/1

Non Serrated
Nicht Gezahnt
Non dentelé
No dentado
No dentellato

SSI-LK-12
160 mm

Tungsten-Carbide Inserts
Mit Hartmetalleinsätzen
Plaquettes en carbure de tungstène
Plaquetas de carburo de tungsteno
Inserti in carburo di tungsteno

Eine Schneide gezahnt S-förmig gebogen
One toothed cutting edge S-shaped
Una lama dentata curva a forma S
Una hoja dentada forma S
Une lame dentelée courbés en S



Super Cut

1/1

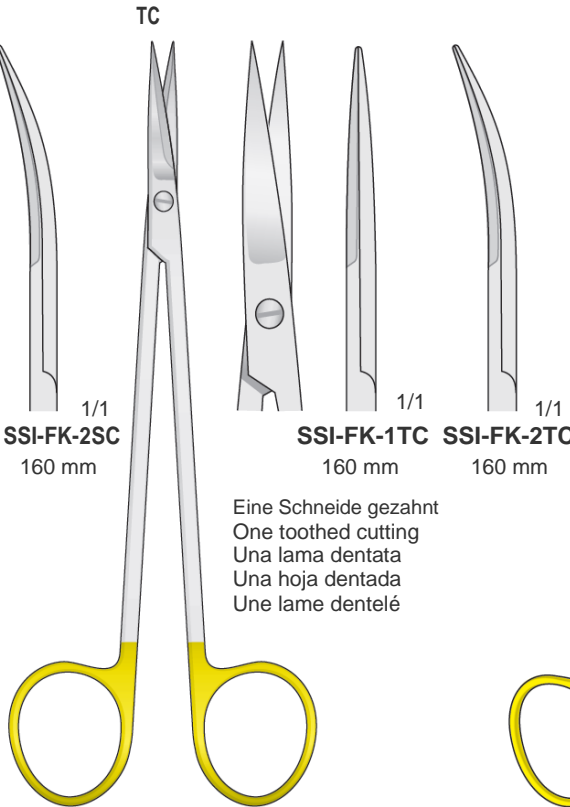
SSI-FK-1SC
160 mm

1/1

SSI-FK-2SC
160 mm

Eine Schneide gezahnt
One toothed cutting
Una lama dentata
Una hoja dentada
Une lame dentelé

KELLY
SSI-FK-1SC/SSI-FK-2SC
160 mm



TC

1/1

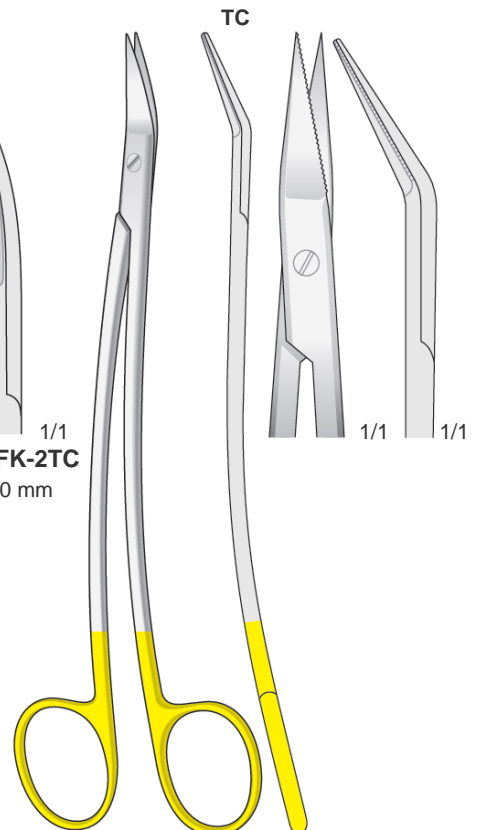
SSI-FK-1TC
160 mm

1/1

SSI-FK-2TC
160 mm

Eine Schneide gezahnt
One toothed cutting
Una lama dentata
Una hoja dentada
Une lame dentelé

KELLY
SSI-FK-1TC / SSI-FK-2TC
160 mm



TC

1/1

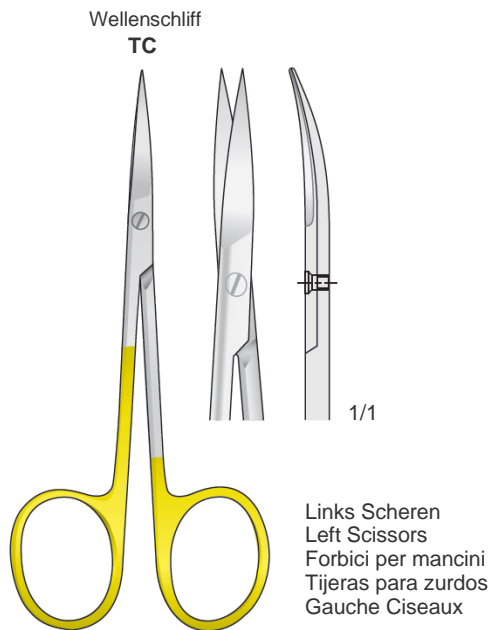
1/1

DEAN-TC
175 mm

Email: sheffieldsurgicalinstruments@gmail.com
Web: www.sheffieldsurgicalinst.com

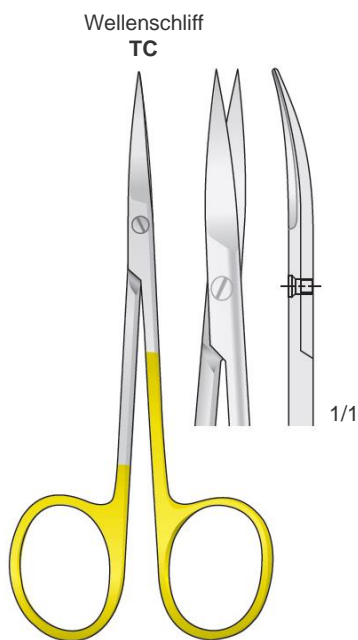


Scheren
Scissors
Forbici
Tijeras
Ciseaux

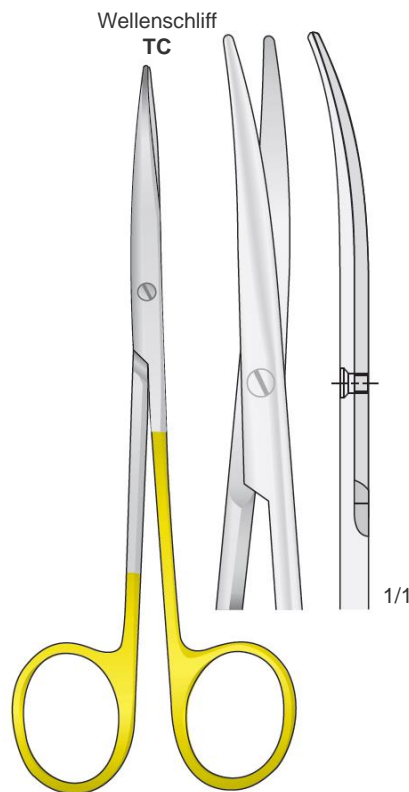


IRIS
SSI-FM-100L
110 mm

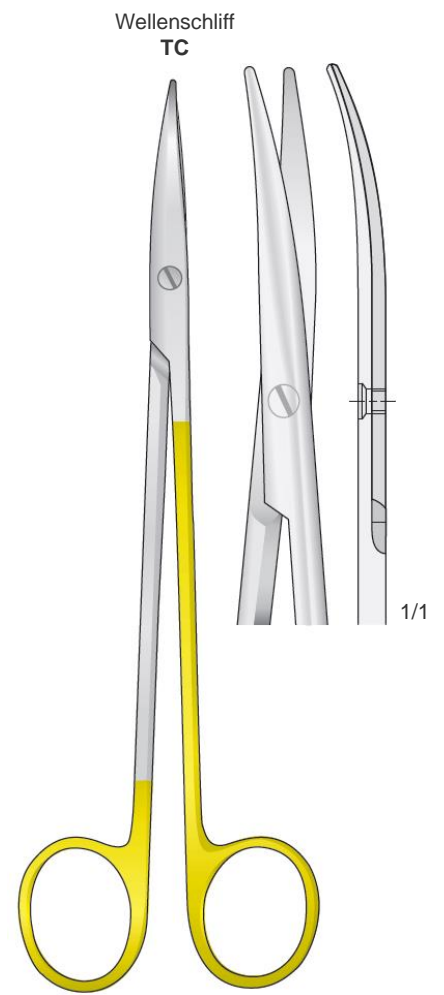
Tungsten-Carbide Inserts
Mit Hartmetalleinsätzen
Plaquettes en carbure de tungstène
Plaquetas de carburo de tungsteno
Inserti in carburo di tungsteno



IRIS
SSI-FM-100
110 mm



METZENBAUM
SSI-FM-102
145 mm



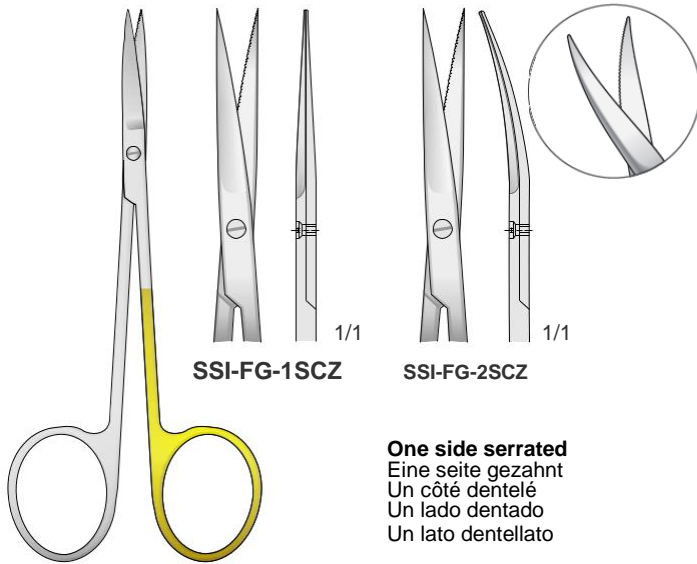
METZENBAUM
SSI-FM-104
185 mm

Email: sheffieldsurgicalinstruments@gmail.com
Web: www.sheffieldsurgicalinst.com



Scheren
Scissors
Forbici
Tijeras
Ciseaux

Extremely Sharp Razor Edge / Atraumatic
Extrem Scharfe Spitzer Beck / Atraumatische
Tranchant extrêmement aiguisée / Atraumatique
Borde extremadamente a lado / Atraumática
Taglio estremamente a lato / Atraumatica

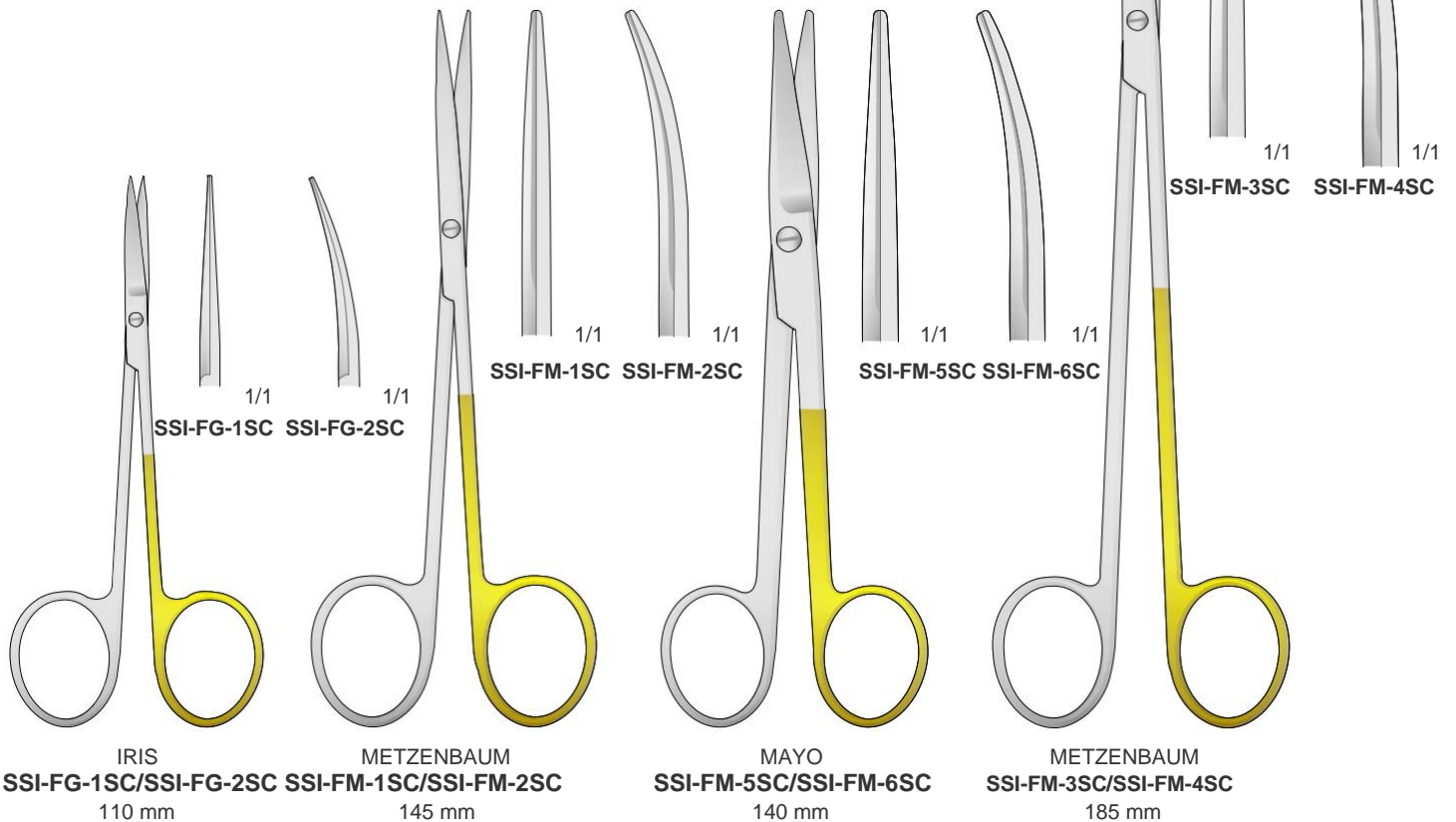


SSI-FG-1SCZ

SSI-FG-2SCZ

One side serrated
Eine seite gezahnt
Un côté dentelé
Un lado dentado
Un lato dentellato

SSI-FG-1SCZ/SSI-FG-2SCZ
110 mm



SSI-FG-1SC SSI-FG-2SC

SSI-FM-1SC SSI-FM-2SC

SSI-FM-5SC SSI-FM-6SC

SSI-FM-3SC SSI-FM-4SC

IRIS
SSI-FG-1SC/SSI-FG-2SC
110 mm

METZENBAUM
SSI-FM-1SC/SSI-FM-2SC
145 mm

MAYO
SSI-FM-5SC/SSI-FM-6SC
140 mm

METZENBAUM
SSI-FM-3SC/SSI-FM-4SC
185 mm

Email: sheffieldsurgicalinstruments@gmail.com
Web: www.sheffieldsurgicalinst.com

SUPER CUT

Regular
Edge

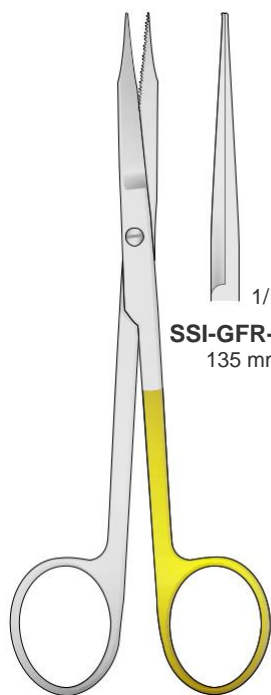
SUPER CUT
Edge

Super Cut Scissors have specially designed cutting edges.
One regular edge and **one sharp-knife edge.**

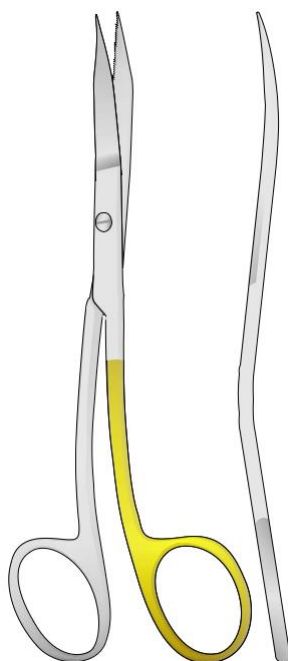
Extremely Sharp Razor Edge / Atraumatic
Extrem Scharfe Spitzer Beck / Atraumatische
Tranchant extrêmement aiguisée / Atraumatique
Borde extremadamente a lado / Atraumática

Taglio estremamente alato / Atraumatica

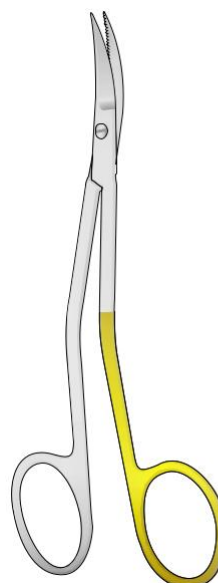
One side serrated
Eine seite gezahnt
Un côté dentelé
Un lado dentado
Un lato dentellato



GOLDMAN-FOX
SSI-GFR-SC/SSI-GFC-SC
135 mm



GOLDMAN-FOX S FORM
SSI-GFS-SC
130 mm



LA GRANGE
SSI-LG-1SC/SSI-LG-2SC
115 mm

Spitz
Sharp
Acute
Agudas
Pointu

Stumpf
Blunt
Smusse
Romas
Mousse



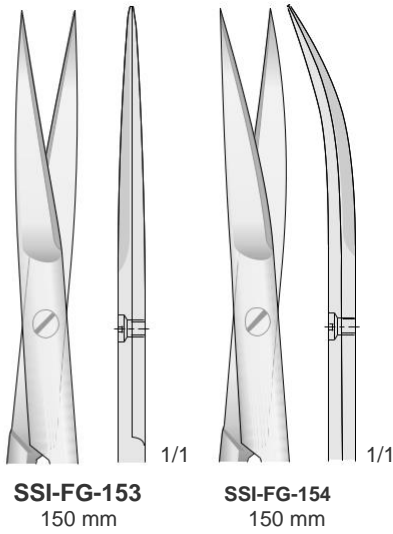
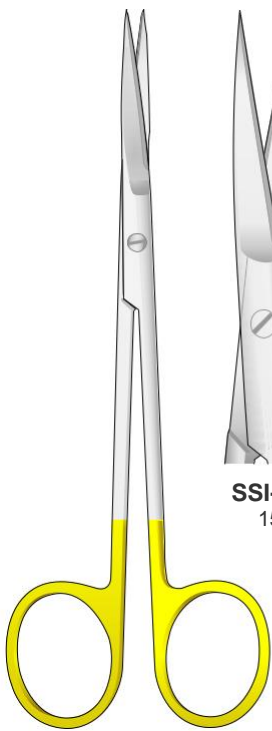
LA GRANGE **LA GRANGE** **LA GRANGE**
SSI-LG-1SC **SSI-LG-1SC** **SSI-LG-2SC**

Email: sheffieldsurgicalinstruments@gmail.com
Web: www.sheffieldsurgicalinst.com



Scheren
Scissors
Forbici
Tijeras
Ciseaux

TC



SSI-FG-153
150 mm

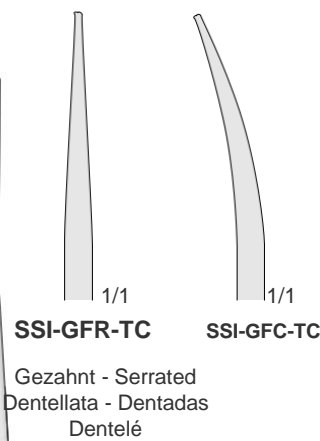
SSI-FG-154
150 mm



JOSEPH
SSI-FG-153/SSI-FG-154
150 mm



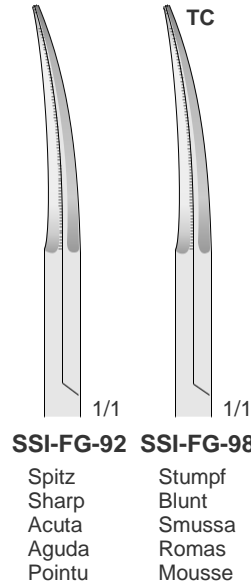
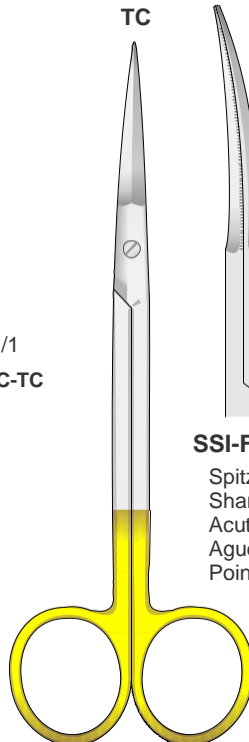
TC



SSI-GFR-TC
SSI-GFC-TC
Gezahnt - Serrated
Dentellata - Dentadas
Dentelé

GOLDMAN-FOX
SSI-GFC-TC/SSI-GFR-TC
135 mm

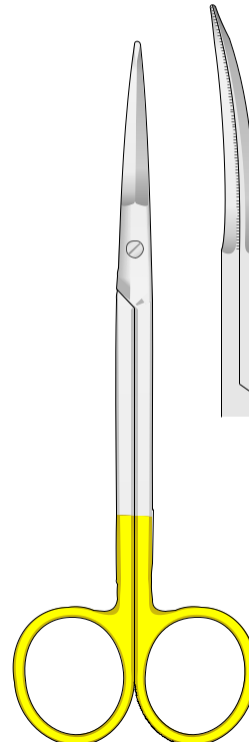
TC



SSI-FG-92 **SSI-FG-98**
Spitz
Sharp
Acuta
Aguda
Pointu
Stumpf
Blunt
Smussa
Romas
Mousse

PECK-JOSEPH
SSI-FG-92/SSI-FG-98
140 mm

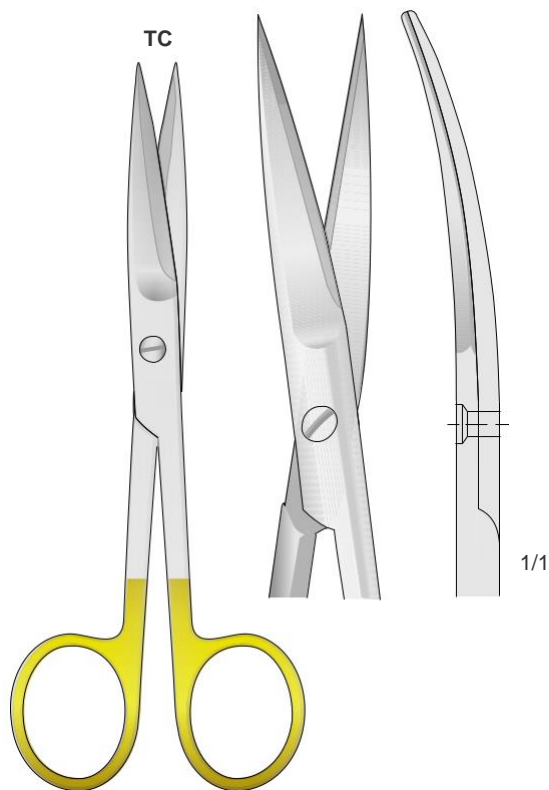
TC



GREGORY
SSI-FM-339
140 mm

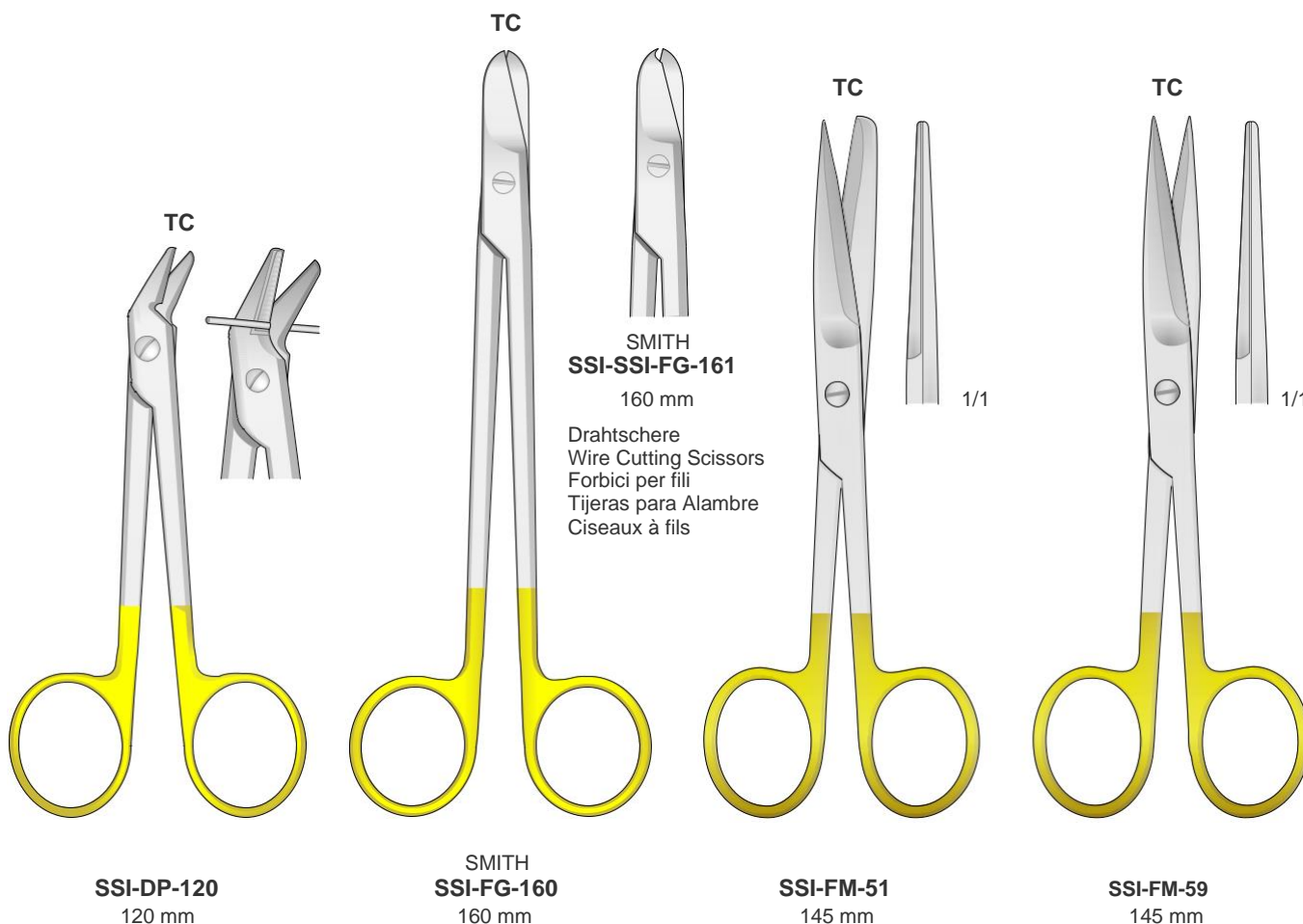
Email: sheffieldsurgicalinstruments@gmail.com
Web: www.sheffieldsurgicalinst.com

Scheren
Scissors
Forbici
Tijeras
Ciseaux



SSI-FM-146
145 mm

TC Tungsten-Carbide Inserts
Mit Hartmetalleinsätzen
Plaquettes en carbure de tungstène
Plaquetas de carburo de tungsteno
Inserti in carburo di tungsteno



SSI-DP-120
120 mm

SMITH SSI-FG-160
160 mm

SSI-FM-51
145 mm

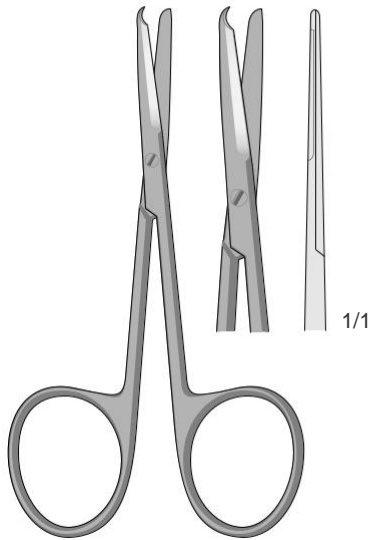
SSI-FM-59
145 mm

SMITH SSI-SSI-FG-161
160 mm
Drahtschere
Wire Cutting Scissors
Forbici per fili
Tijeras para Alambre
Ciseaux à fils

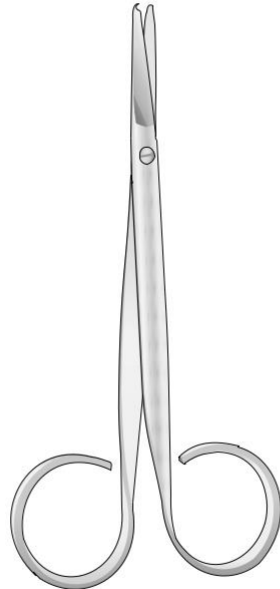
Email: sheffieldsurgicalinstruments@gmail.com
Web: www.sheffieldsurgicalinst.com



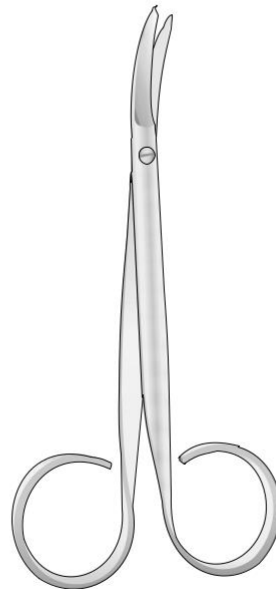
Ligatur Scheren
Ligature Scissors
Forbici per legature
Tijeras para ligaduras
Ciseaux à ligatures



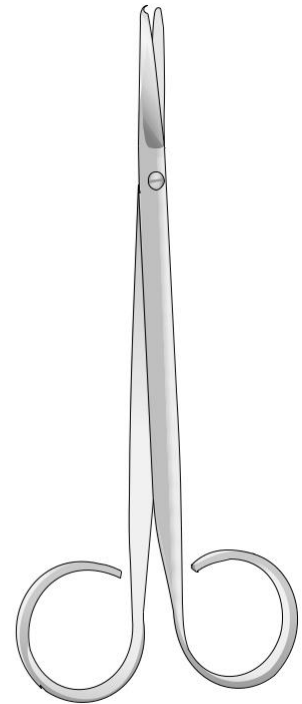
SPENCER
SSI-SC-9
90 mm



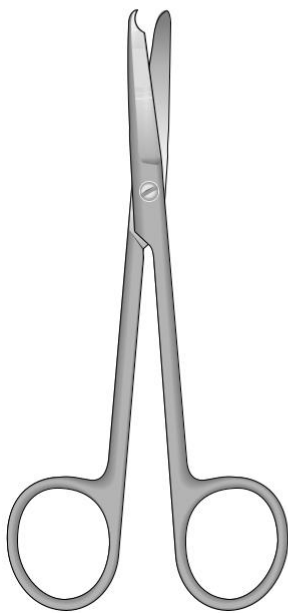
SPENCER
SSI-SC-1
110 mm



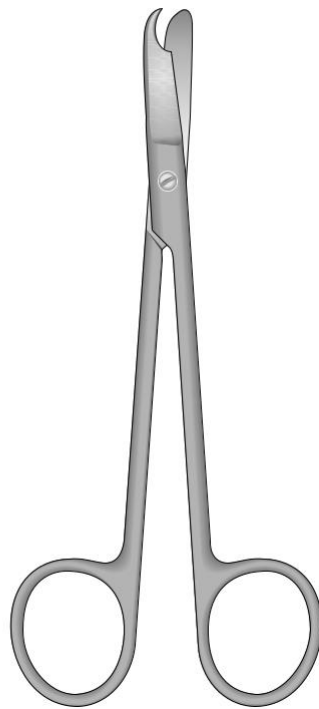
SPENCER
SSI-SC-5
110 mm



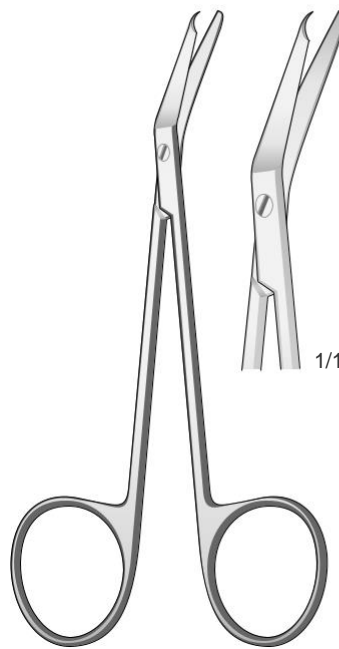
SPENCER
SSI-SC-2
145 mm



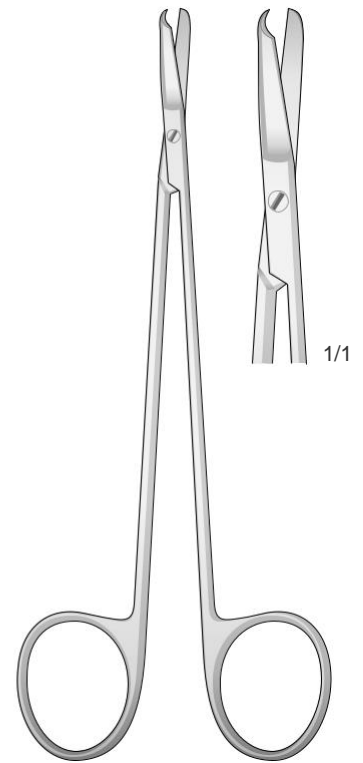
SPENCER
SSI-SC-14
120 mm



LITTAUER
SSI-SC-15
140 mm



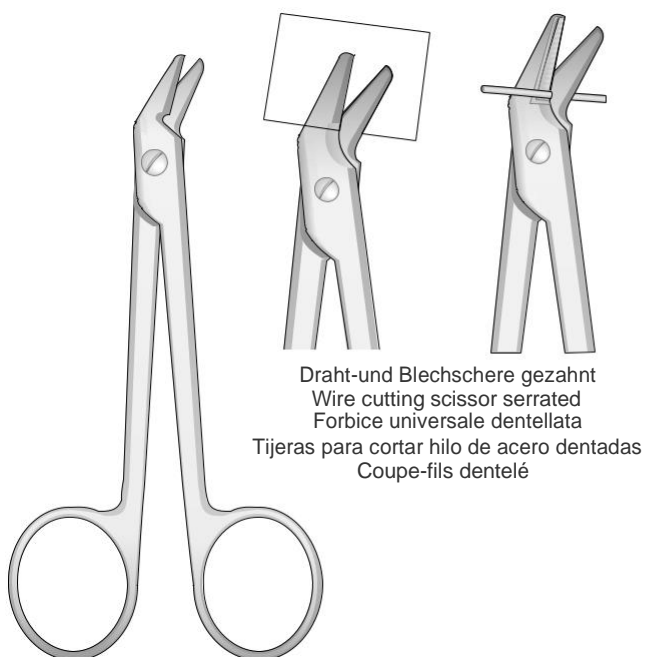
SPENCER
SSI-SC-13
130 mm



KELLY
SSI-SC-16
150 mm

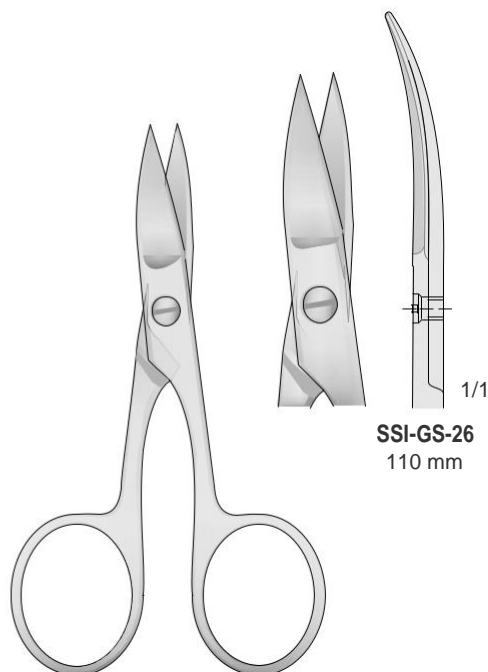
Email: sheffieldsurgicalinstruments@gmail.com
Web: www.sheffieldsurgicalinst.com

Draht und blehscheren
 Wire and plate cutting scissors
 Forbici per fili metallici
 Tijeras para cortar alambre
 Ciseaux coupe-fils métalliques



Draht-und Blehschere gezahnt
 Wire cutting scissor serrated
 Forbice universale dentellata
 Tijeras para cortar hilo de acero dentadas
 Coupe-fils dentelé

SSI-DP-90
 120 mm



SSI-GS-26
 110 mm

SSI-GS-26
 110 mm

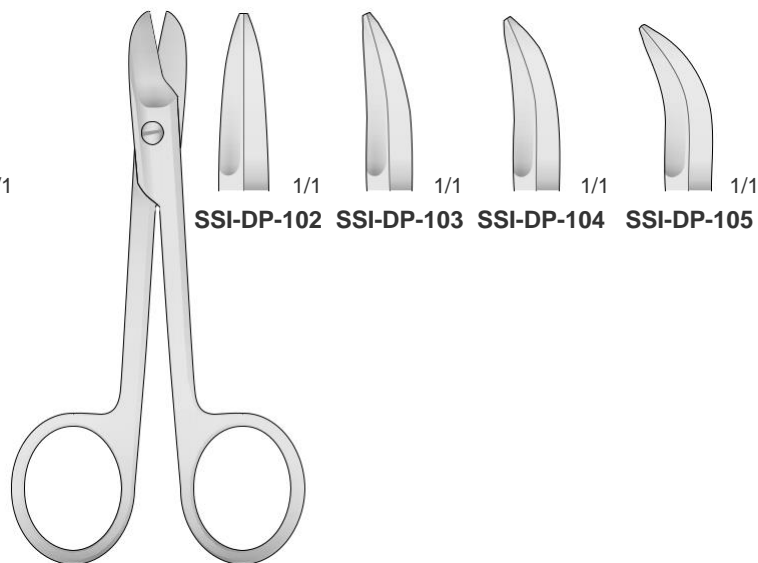
Spitz
 Sharp
 Acute
 Agudas
 Pointu



SSI-DP-91 1/1 **SSI-DP-101** 1/1 **SSI-DP-92** 1/1

BEEBE
SSI-DP-91/SSI-DP-101
 110 mm

Stumpf
 Blunt
 Smusse
 Romas
 Mousse



SSI-DP-102 1/1 **SSI-DP-103** 1/1 **SSI-DP-104** 1/1 **SSI-DP-105** 1/1

BEEBE
SSI-DP-102/SSI-DP-105
 110 mm

Email: sheffieldsurgicalinstruments@gmail.com
 Web: www.sheffieldsurgicalinst.com

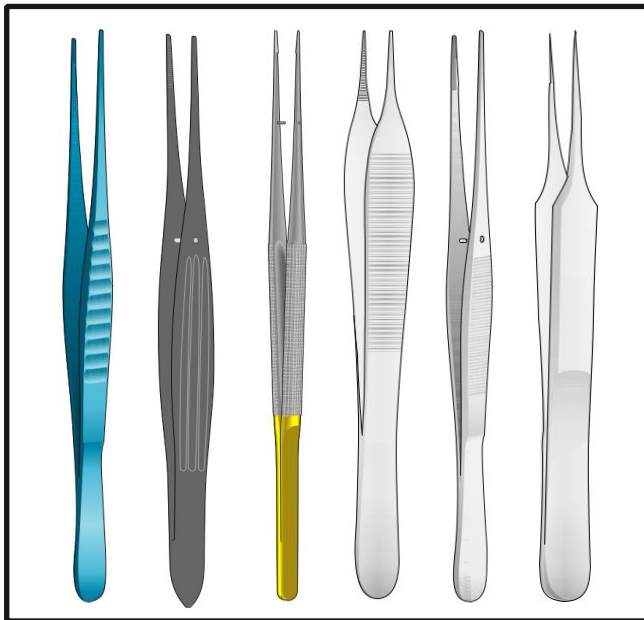
Tissue and Dressing Forceps

Chirurgische und Anatomische Pinzetten

Pinces à tissus et à pansement

Pinzas quirúrgicas y anatómicas

Pinzette chirurgiche e anatomiche



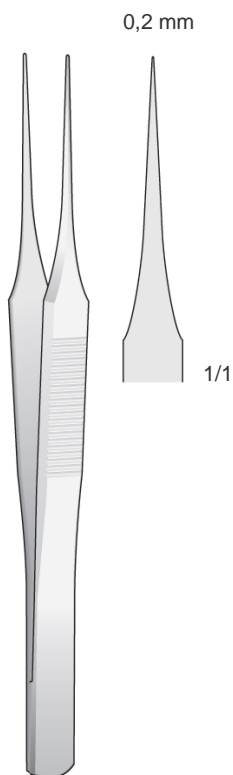
Sheffield Surgical is highly experienced Manufacturer & exporter of high quality Dental Instruments and also in the field of General Surgery, Bone Surgery an Orthopedic Instruments.



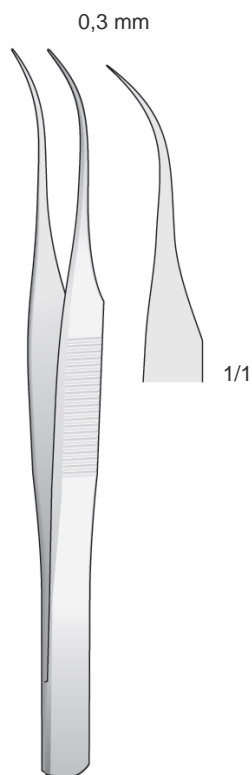
Email: sheffieldsurgicalinstruments@gmail.com

Web: www.sheffieldsurgicalinst.com

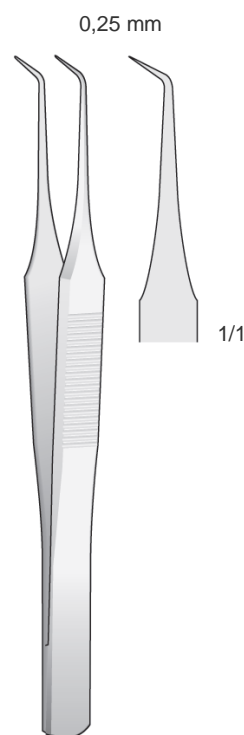
Mikro Pinzetten
 Delicate Forceps
 Micro Pinzette
 Pinzas finas
 Micro Pincas



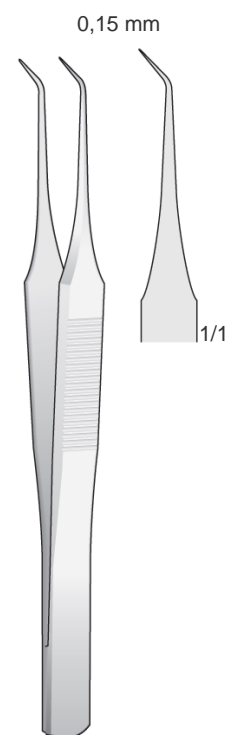
SSI-BD-360
110 mm



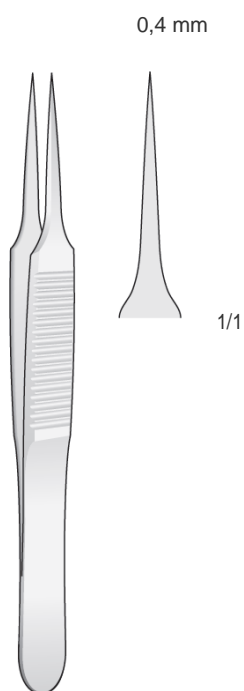
SSI-BD-361
110 mm



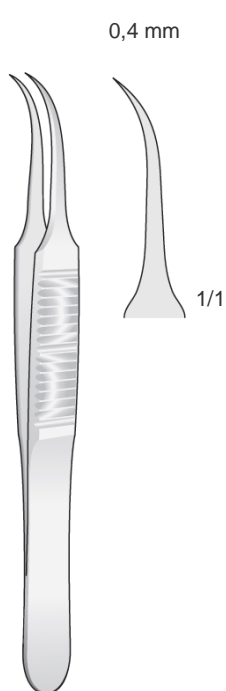
SSI-BD-362
100 mm



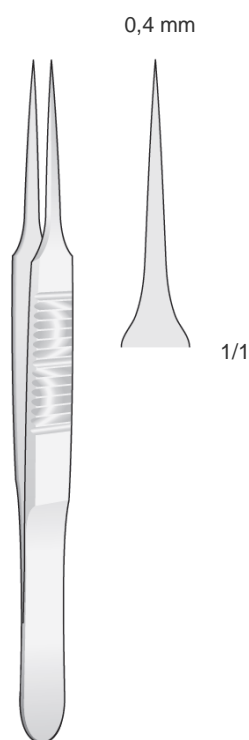
SSI-BD-363
100 mm



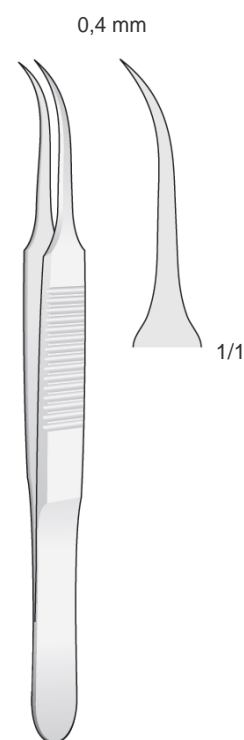
SSI-BD-364
110 mm



SSI-BD-365
110 mm



SSI-BD-366
130 mm



SSI-BD-367
130 mm

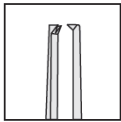
Email: sheffieldsurgicalinstruments@gmail.com
 Web: www.sheffieldsurgicalinst.com



Mikro Pinzetten
Delicate Forceps
Micro Pinzette
Pinzas finas
Micro Pincas

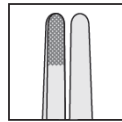
Diamond Tip
Diamantiert
Punta diamantata
Punta de diamante
Pointe de diamant

Tissue Forceps
1x2 Teeth



BISHOP-HARMON
SSI-MF-177 1,2 mm
85 mm

Dressing Forceps
criss-cross serrated tips



BISHOP-HARMON
SSI-MF-249 1,2 mm
85 mm

1/1
1x2 Zähne
1x2 Teeth
1x2 Denti
1x2 Dientes
1x2 Dents



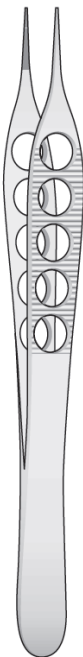
CASTROVIEJO
SSI-BD-348 0.9 mm
120 mm

1/1
9x9 Zähne
9x9 Teeth
9x9 Denti
9x9 Dientes
9x9 Dents

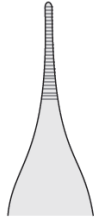


BROWN
SSI-BD-349
120 mm

1,2 mm

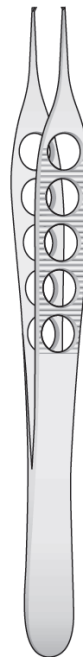


ADSON
SSI-BD-207
120 mm

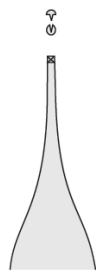


1/1

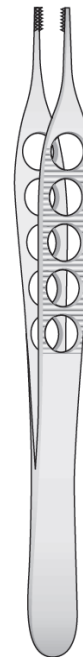
1,2 mm



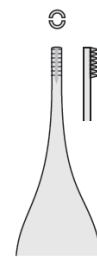
ADSON
SSI-BD-208
120 mm



1/1



ADSON-BROWN
SSI-BD-209
120 mm

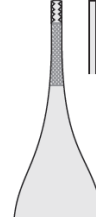


1/1

7x7 Zähne
7x7 Teeth
7x7 Denti
7x7 Dientes
7x7 Dents



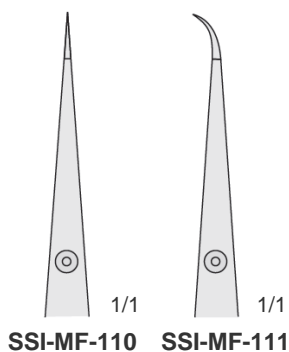
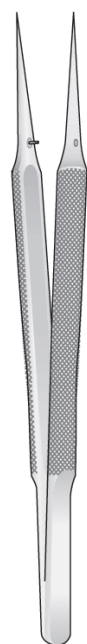
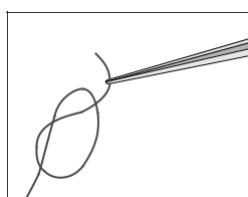
ADSON-BROWN
SSI-BD-253
120 mm



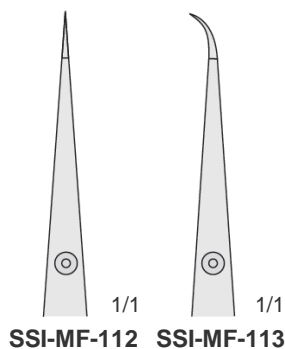
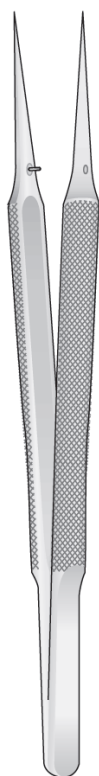
1/1

Email: sheffieldsurgicalinstruments@gmail.com
Web: www.sheffieldsurgicalinst.com

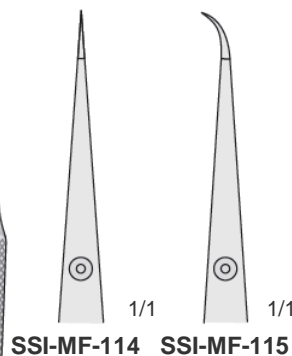
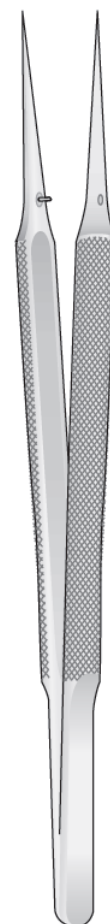
Mikro Pinzetten
 Delicate Forceps
 Micro Pinzette
 Pinzas finas
 Micro Pincers



SSI-MF-110/SSI-MF-111
 120 mm



SSI-MF-112/SSI-MF-113
 150 mm



SSI-MF-114/SSI-MF-115
 180 mm

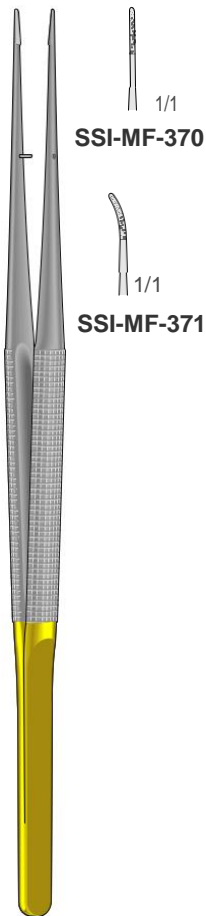
Email: sheffieldsurgicalinstruments@gmail.com
 Web: www.sheffieldsurgicalinst.com



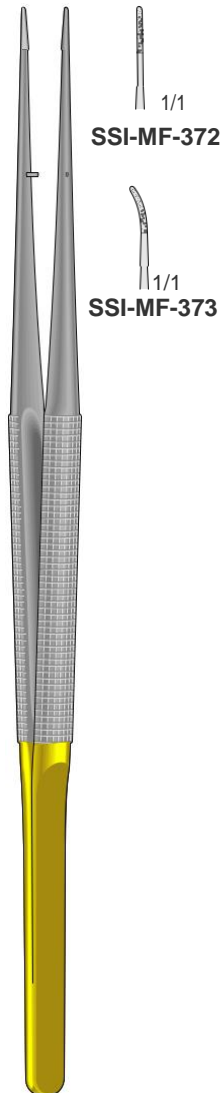
Mikro Pinzette - Rundgriff Ø 8 mm
Mit Führungsstift diamantiert
Fadenplatte 6x0,7 mm

Mikro Pinzetten
Micro Forceps
Micro Pinzette
Micro Pinzas
Micro Pincés

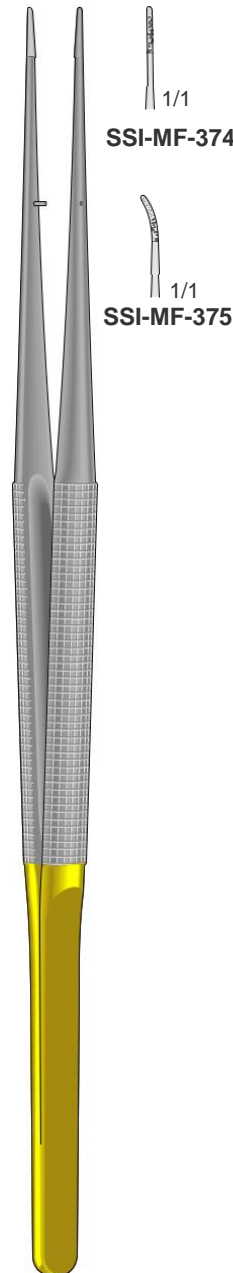
Diamond Tip
Diamantiert
Punta diamantata
Punta de diamante
Pointe de diamant



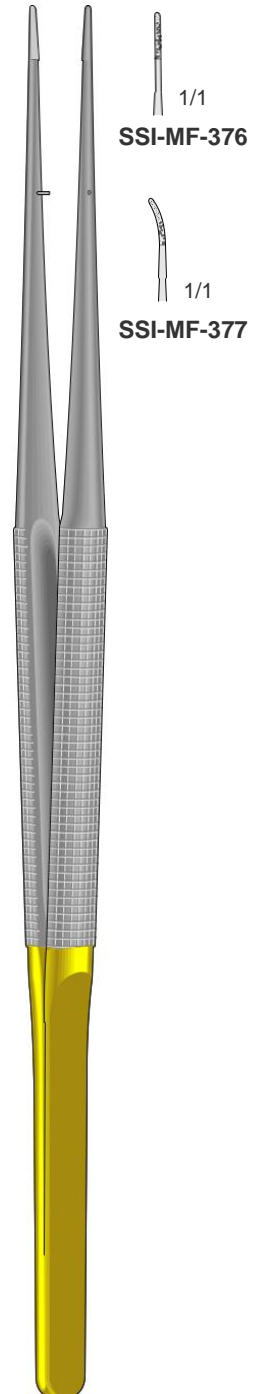
SSI-MF-370/SSI-MF-371
150 mm



SSI-MF-372/SSI-MF-373
180 mm



SSI-MF-374/SSI-MF-375
210 mm



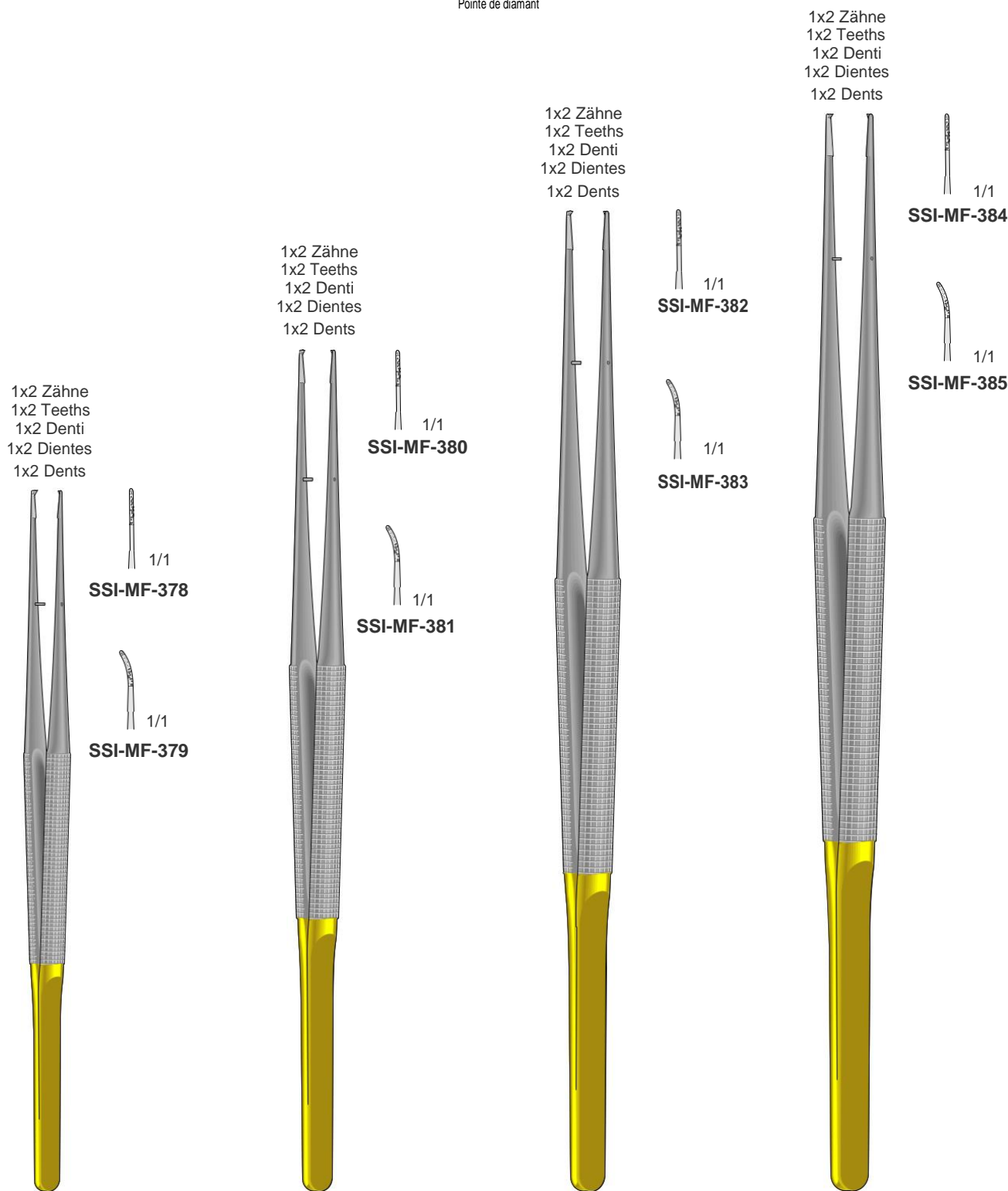
SSI-MF-376/SSI-MF-377
230 mm

Email: sheffieldsurgicalinstruments@gmail.com
Web: www.sheffieldsurgicalinst.com

Mikro Pinzetten
 Micro Forceps
 Micro Pinzette
 Micro Pinzas
 Micro Pincers

Mikro Pinzette - Rundgriff Ø 8 mm
 Mit Führungsstift diamantiert
 Fadenplatte 6x0,7 mm

Diamond Tip
 Diamantiert
 Punta diamantata
 Punta de diamante
 Pointe de diamant



SSI-MF-378/SSI-MF-379
 150 mm

SSI-MF-380/SSI-MF-381
 180 mm

SSI-MF-382/SSI-MF-383
 210 mm

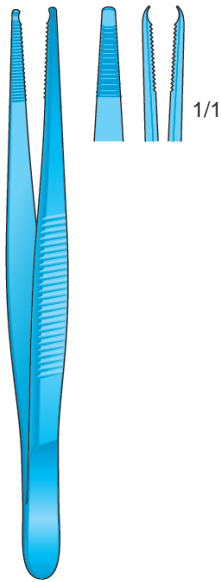
SSI-MF-384/SSI-MF-385
 230 mm

Email: sheffieldsurgicalinstruments@gmail.com
 Web: www.sheffieldsurgicalinst.com

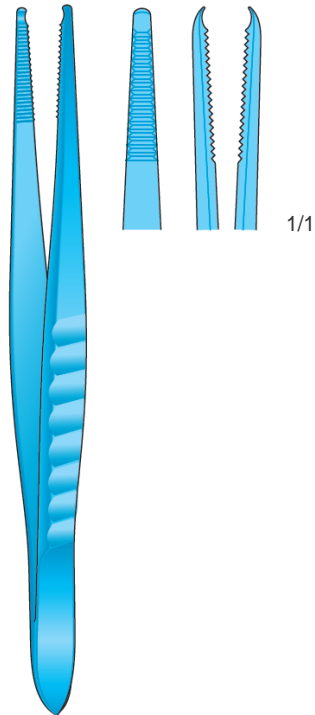


Titan-Pinzetten
Titanium Tissue Forceps
Pinzette in titanio
Pinzas de titanio
Pincas en titane

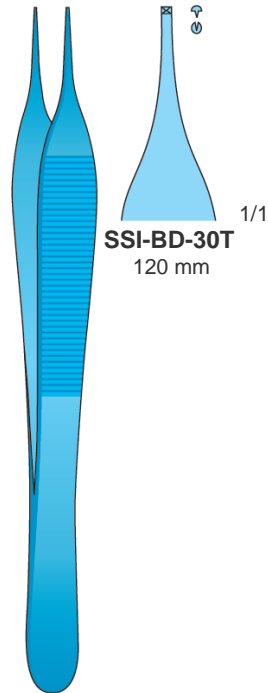
Titanium
Titan
Titane
Titanio
Titano



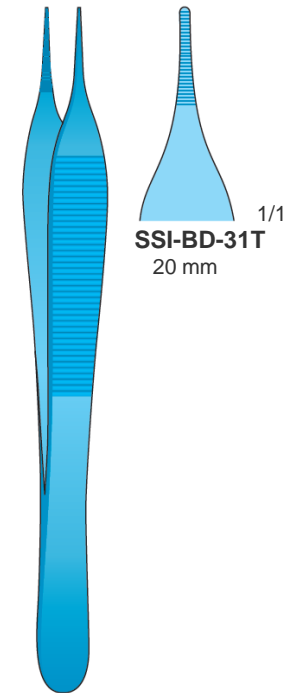
SSI-BD-285T
90 mm



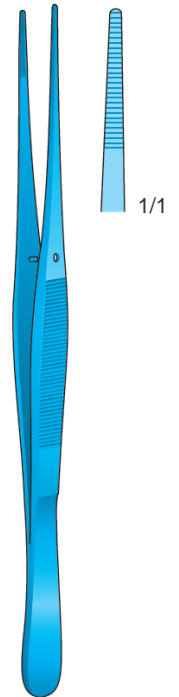
SSI-BD-270T
130 mm



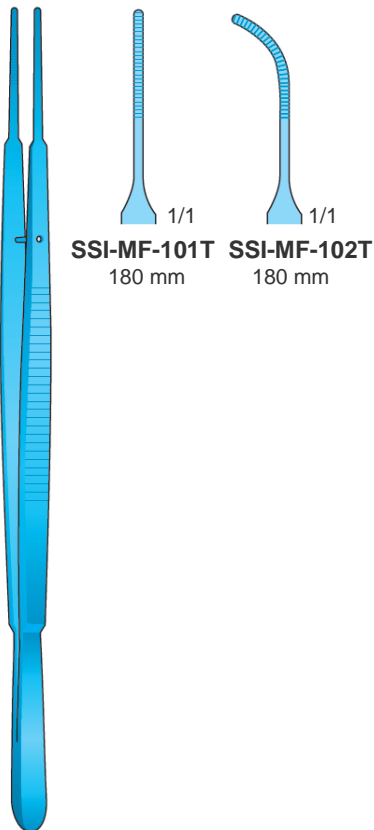
ADSON
SSI-BD-30T
120 mm



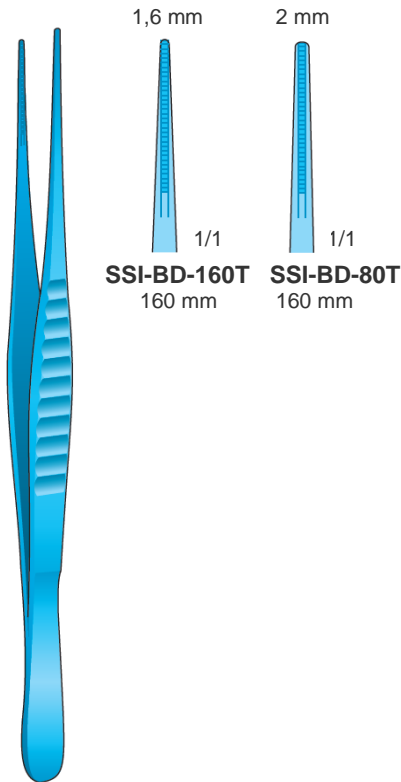
ADSON
SSI-BD-31T
120 mm



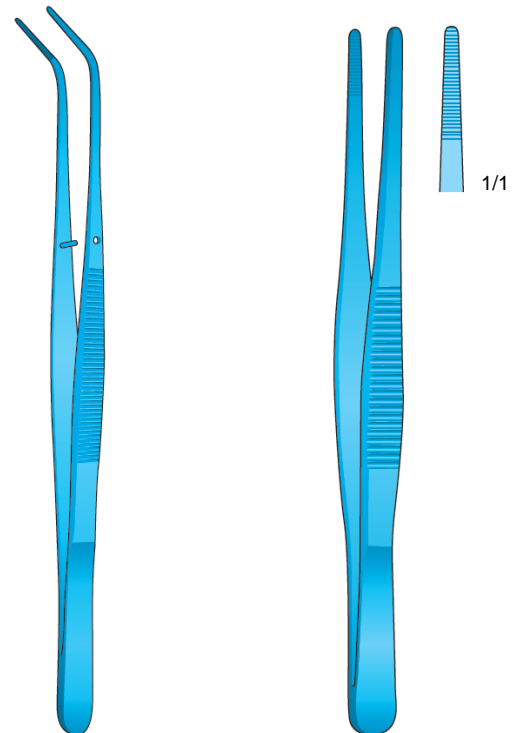
SSI-BD-09T
130 mm



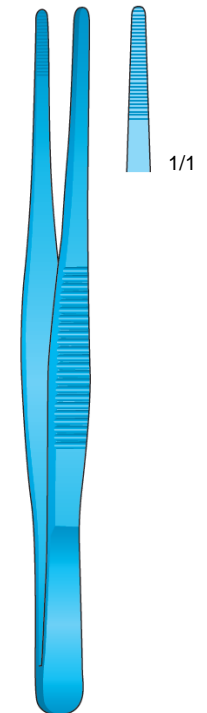
GERALD
SSI-MF-101T/SSI-MF-102T
180 mm



DE BAKEY
SSI-BD-80T/SSI-BD-160T



SSI-COLLEGE
SSI-TT-01
150 mm

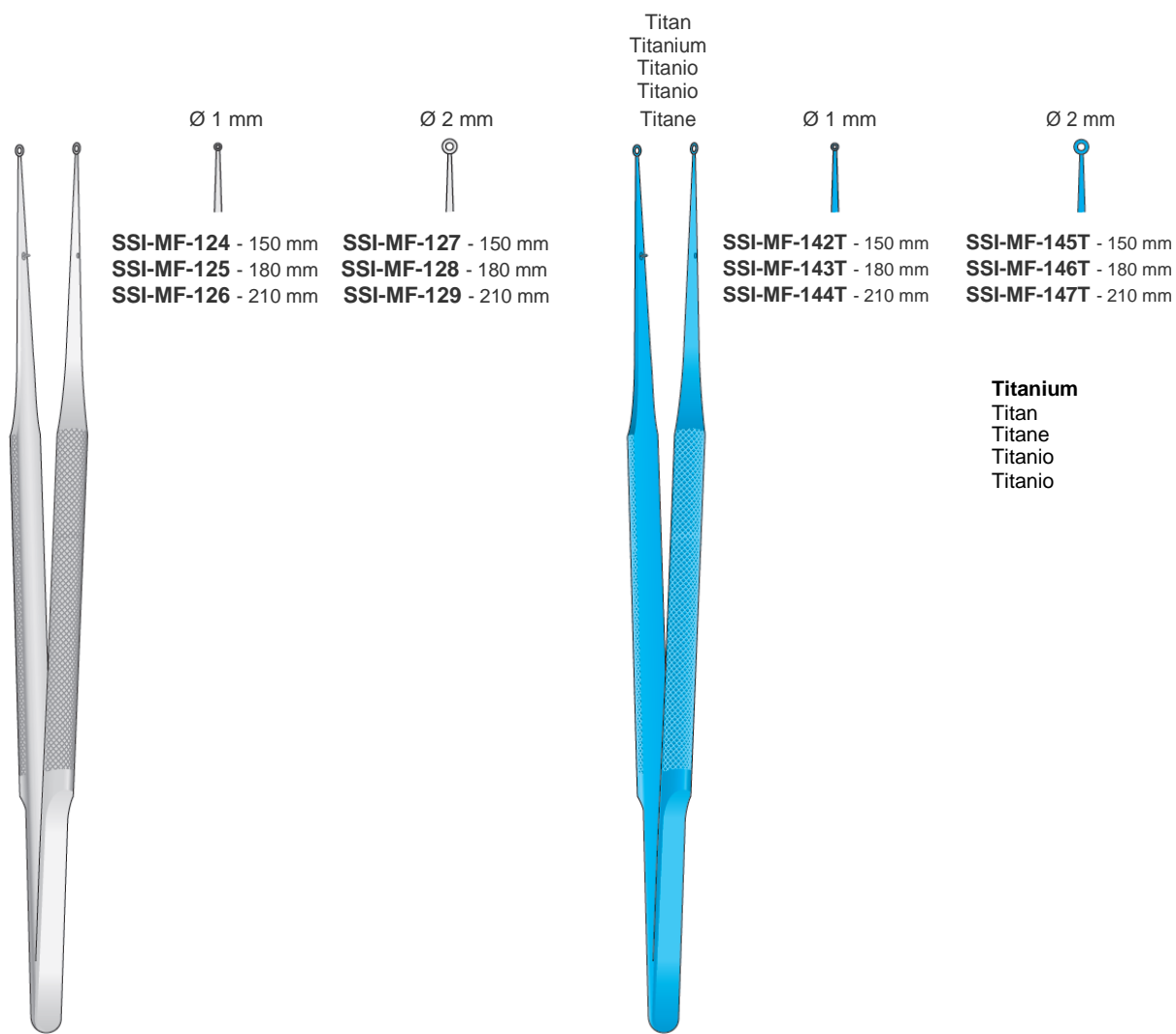


SSI-BD-75T
145 mm

Email: sheffieldsurgicalinstruments@gmail.com
Web: www.sheffieldsurgicalinst.com

Mikro Pinzetten
Delicate Forceps
Micro Pinzette
Pinzas finas
Micro Pincers

Rund-Griffe Ø 8 mm
Round handle Ø 8 mm
Manico rotondo Ø 8 mm
Mango redondo Ø 8 mm
Manche rond Ø 8 mm



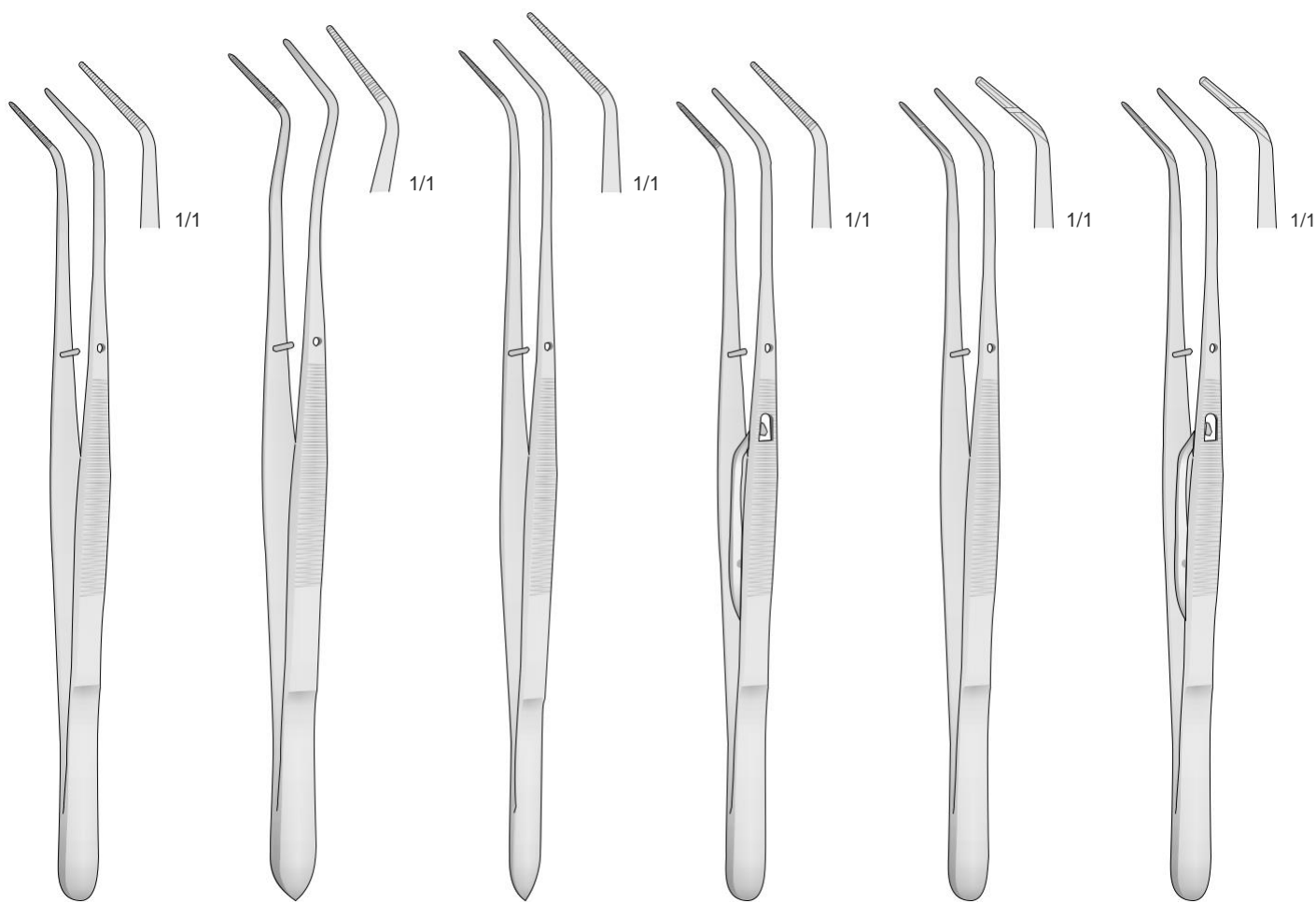
SSI-MF-124/SSI-MF-129

SSI-MF-142T/SSI-MF-147T

Email: sheffieldsurgicalinstruments@gmail.com
Web: www.sheffieldsurgicalinst.com



Zahnpinzetten Cotton and
Dressing Pliers Pinzette
per medicazione Pinzas
para vendajes Précelles
pour cotton



SSI-COLLEGE
150 mm

SSI-MERIAM
160 mm

SSI-FALGG
160 mm

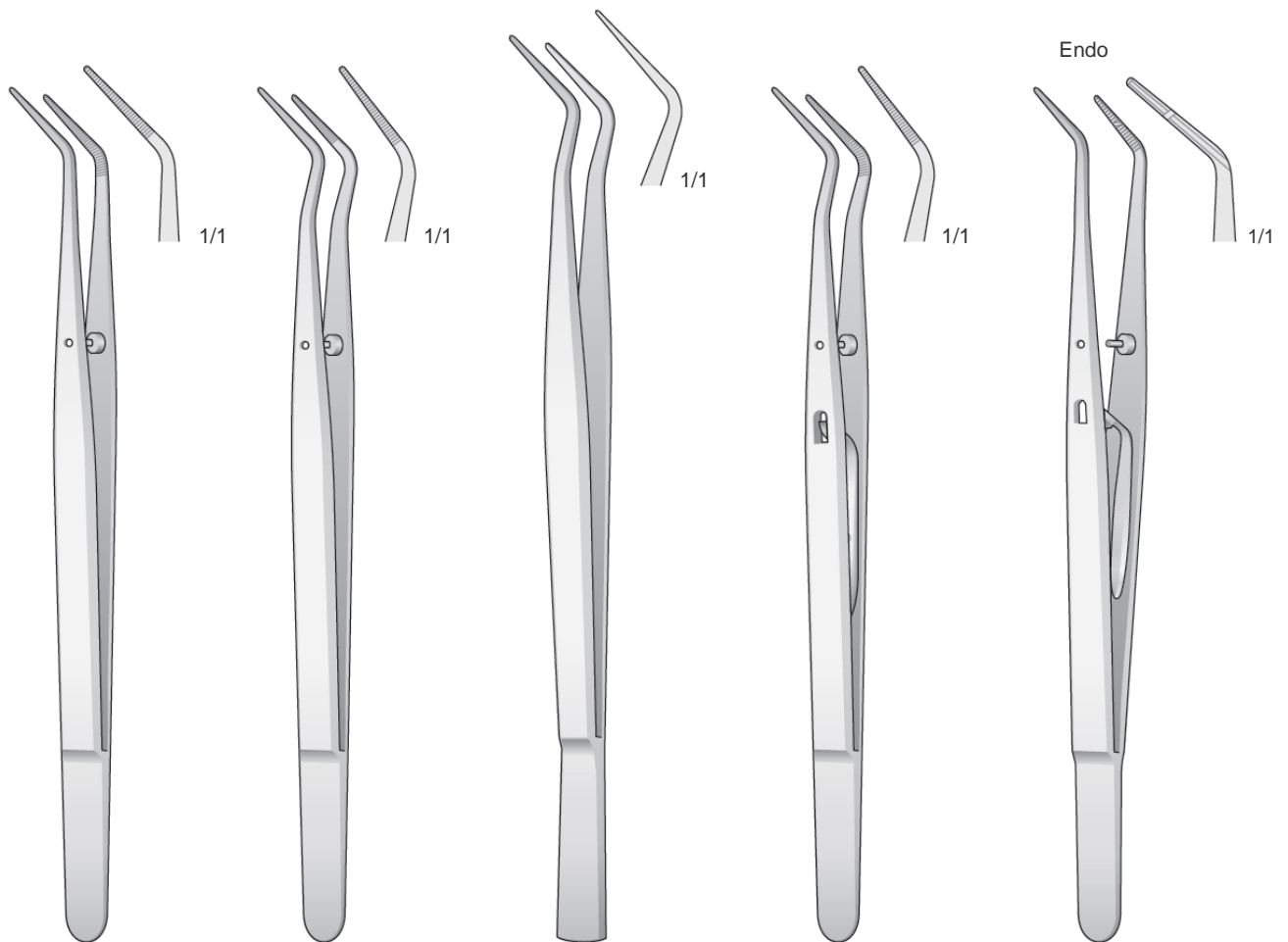
SSI-COLLEGE-S
150 mm

SSI-DA-04
150 mm

SSI-DA-05
150 mm

Email: sheffieldsurgicalinstruments@gmail.com
Web: www.sheffieldsurgicalinst.com

Zahnpinzetten
 Cotton and Dressing Pliers
 Pinzette per medicazione
 Pinzas para vendajes
 Précelles pour cotton



SSI-COLLEGE
SSI-BD-01 Fig.17
 150 mm

SSI-MERIAM
SSI-BD-02 Fig.18
 150 mm

CAULK
SSI-BD-11
 160 mm

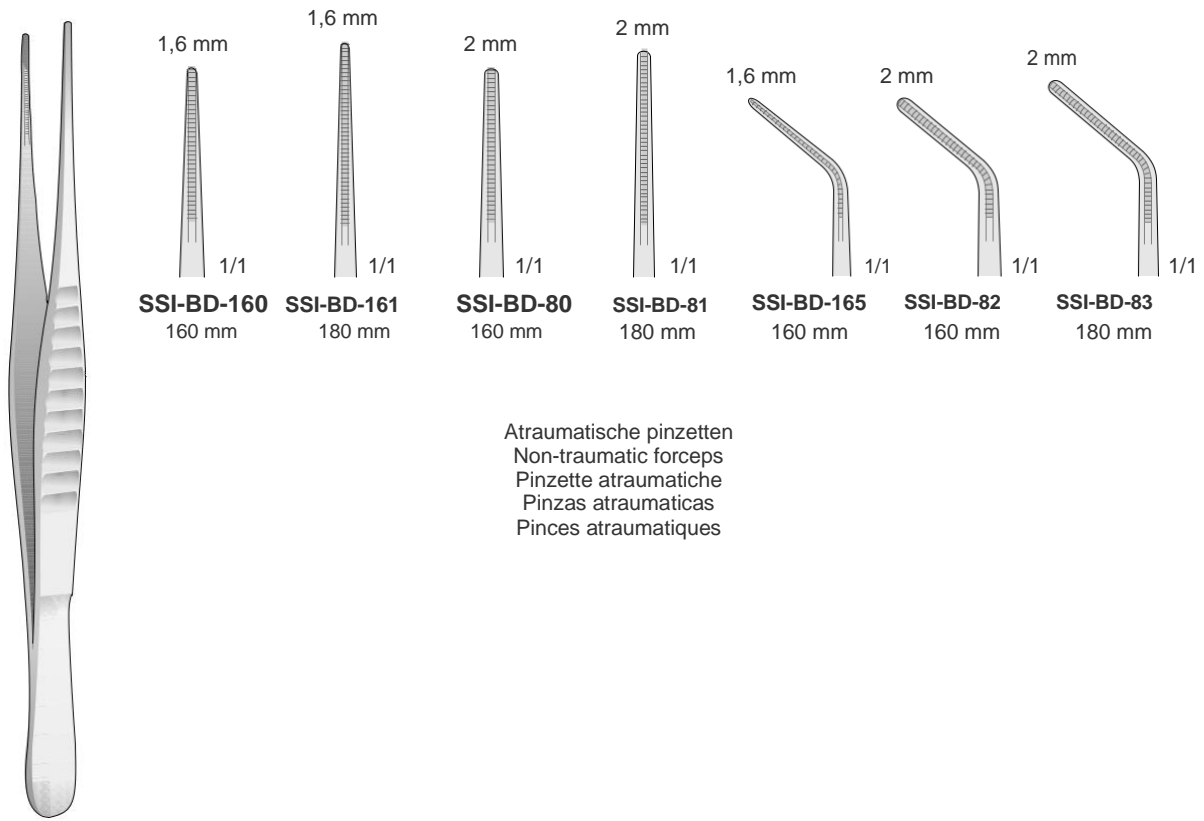
LOCKING
SSI-BD-03 Fig.18L
 150 mm

SSI-DA-09
 150 mm

Email: sheffieldsurgicalinstruments@gmail.com
 Web: www.sheffieldsurgicalinst.com

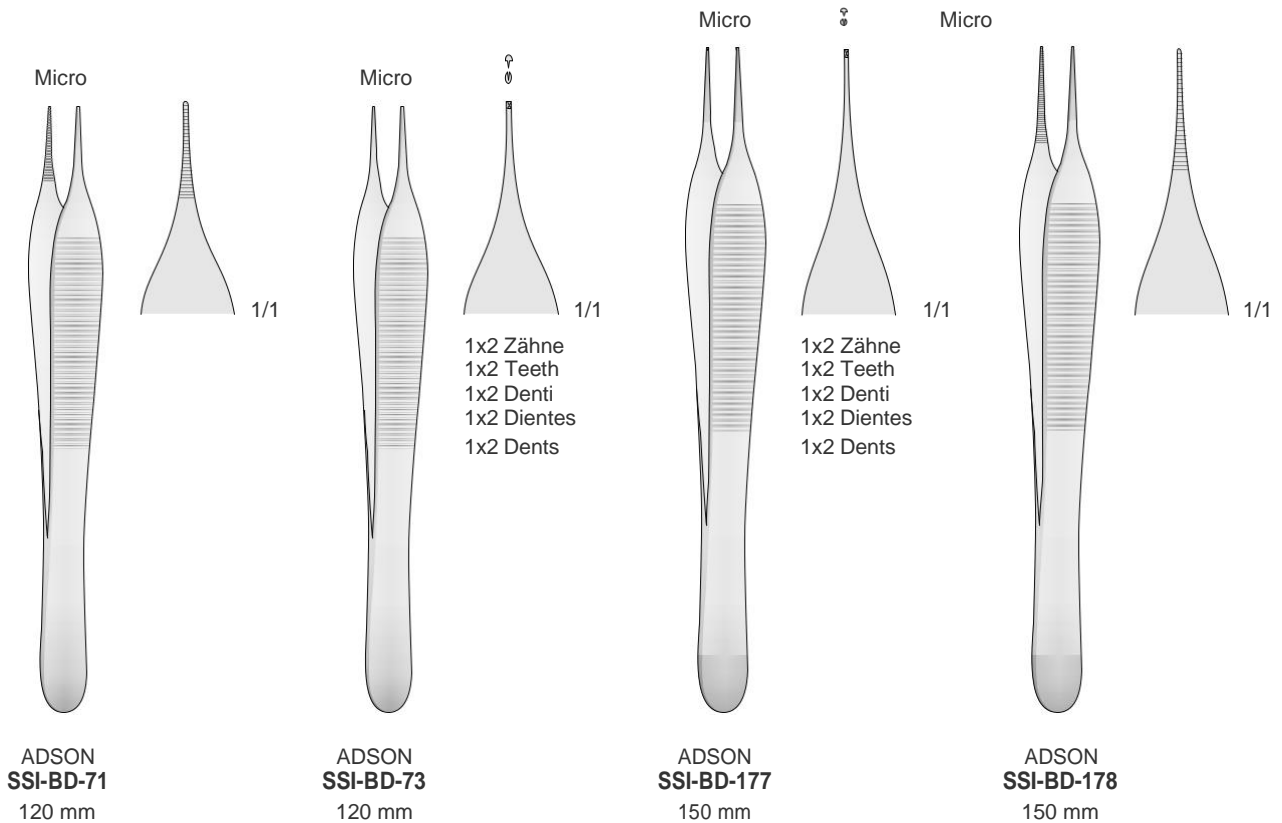


Chirurgische und Anatomische Pinzetten
 Tissue and Dressing Forceps
 Pinzette anatomiche e chirurgiche
 Pinzas de diseccion y chirùrgicas
 Pincas anatomiques chirurgicales



Atraumatische pinzetten
 Non-traumatic forceps
 Pinzette atraumatiche
 Pinzas atraumaticas
 Pincas atraumatiques

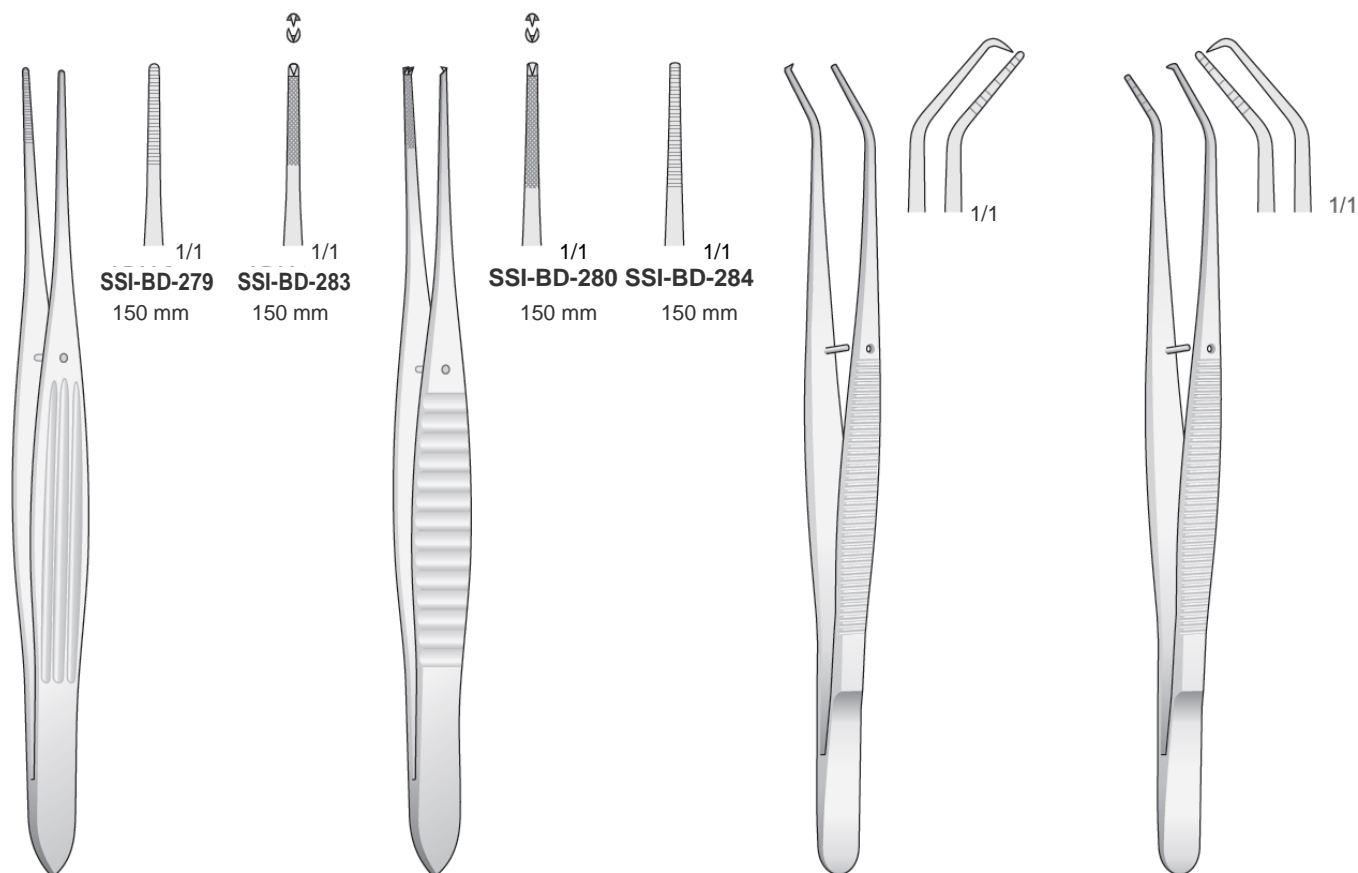
DE BAKEY
 SSI-BD-80/SSI-BD-165



Email: sheffieldsurgicalinstruments@gmail.com
 Web: www.sheffieldsurgicalinst.com

Chirurgische Pinzetten
 Tissue Forceps
 Pinzette chirurgiche
 Pinzas quirùrgicas
 Pincas chirurgicales

Taschenmarkierungspinzetten
 Pocket markers
 Pinzette segnatasche
 Pinzas para marcar el sulco periodontal
 Pincas à marquer la poche



McINDOE
 SSI-BD-279/SSI-BD-283
 150 mm

GILLIES
 SSI-BD-280/SSI-BD-284
 150 mm

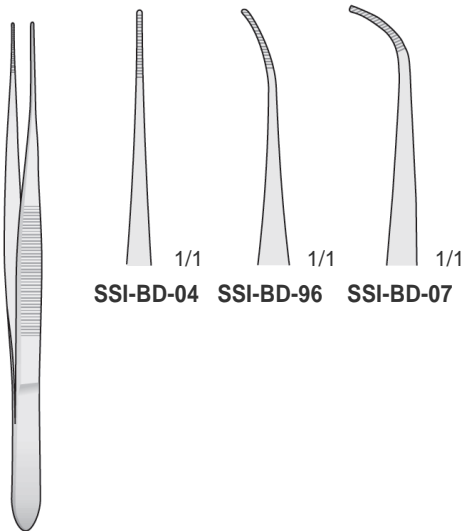
CRANE-CAPLAN
 SSI-DB-01
 150 mm

CRANE-CAPLAN
 SSI-DB-02
 150 mm

Email: sheffieldsurgicalinstruments@gmail.com
 Web: www.sheffieldsurgicalinst.com

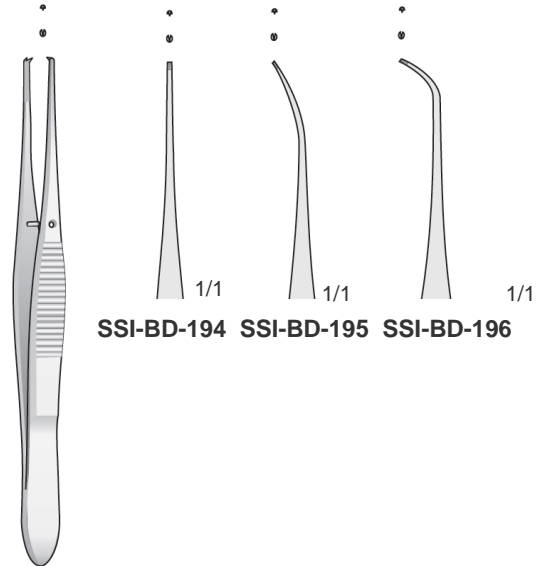


Chirurgische Pinzetten
Tissue Forceps
Pinzette chirurgiche
Pinzas quirúrgicas
Pincas quirúrgicas



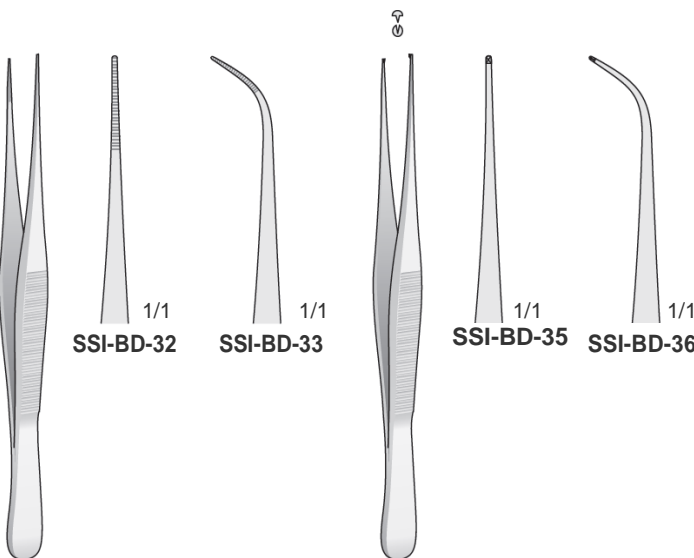
SSI-BD-04 SSI-BD-96 SSI-BD-07

GRAEFE
SSI-BD-04/SSI-BD-96
100 mm



SSI-BD-194 SSI-BD-195 SSI-BD-196

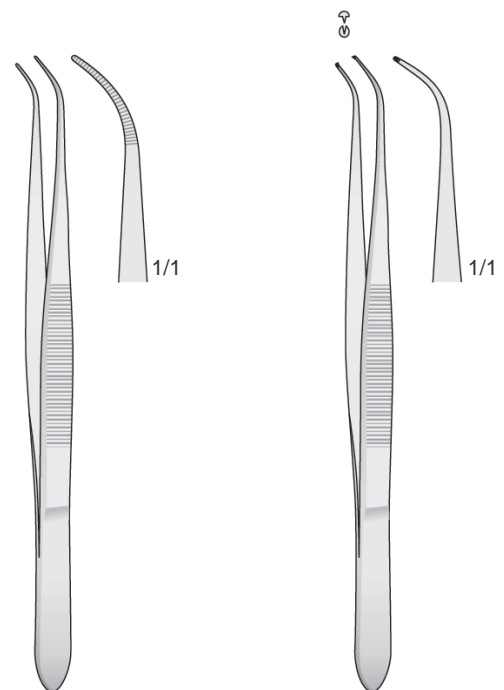
GRAEFE
SSI-BD-194/SSI-BD-196
100 mm



SSI-BD-32 SSI-BD-33 SSI-BD-35 SSI-BD-36

SSI-BD-32/SSI-BD-33
100 mm

SSI-BD-35/SSI-BD-36
100 mm



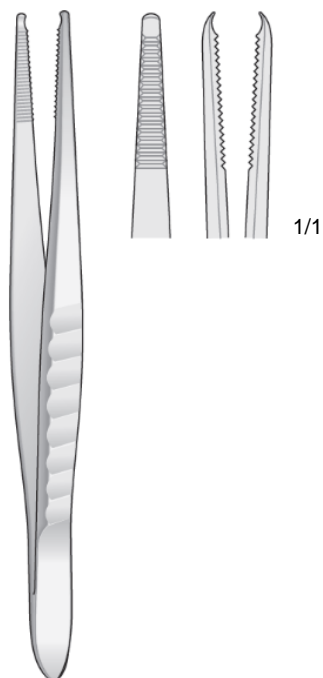
PERRY
SSI-BD-05
125 mm

SSI-BD-06
125 mm

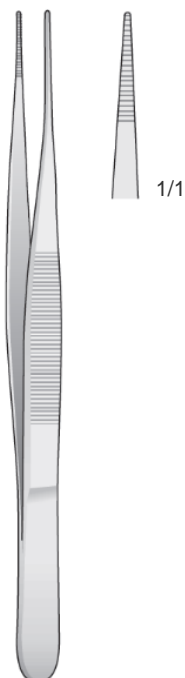
Email: sheffieldsurgicalinstruments@gmail.com
Web: www.sheffieldsurgicalinst.com



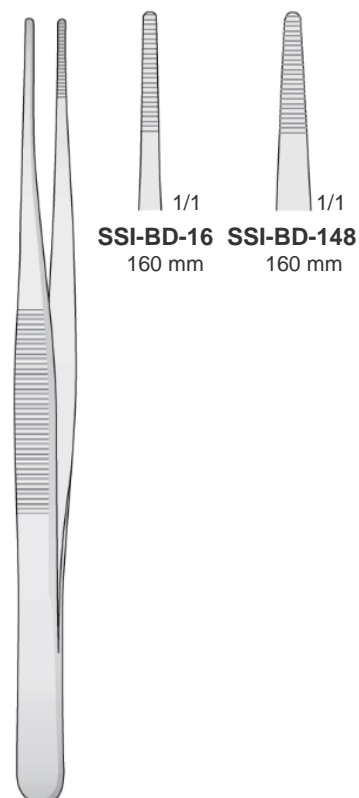
Anatomische Pinzetten
 Dressing Forceps
 Pinzette anatomiche
 Pinzas de diseccion
 Pincas anatomiques



SSI-BD-270
130 mm

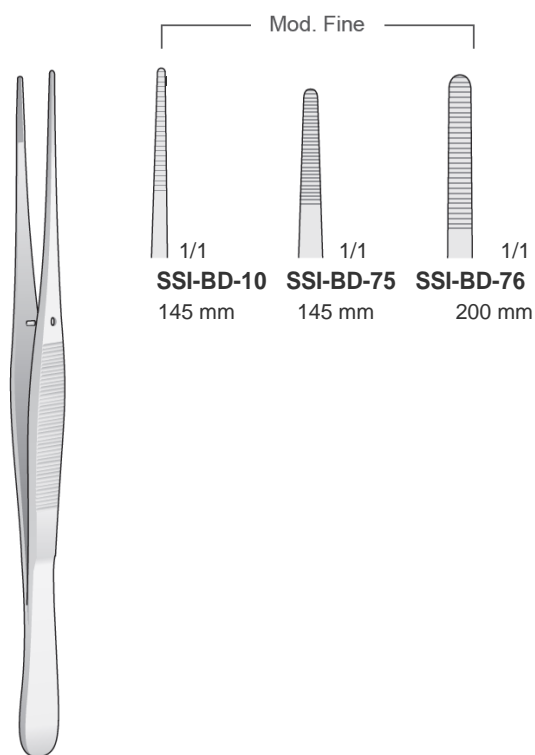


SSI-BD-145
130 mm

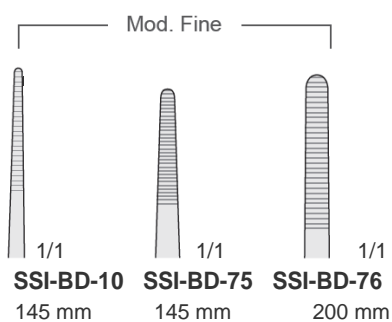


SSI-BD-16 SSI-BD-148
160 mm 160 mm

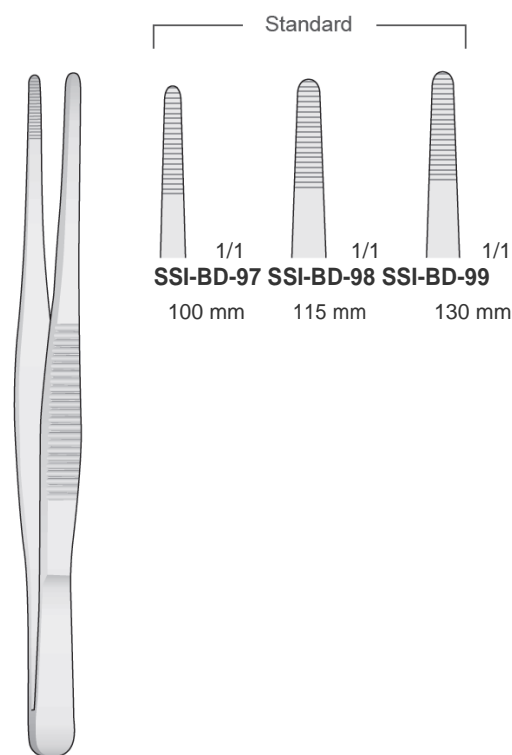
SSI-BD-16/SSI-BD-148
160 mm



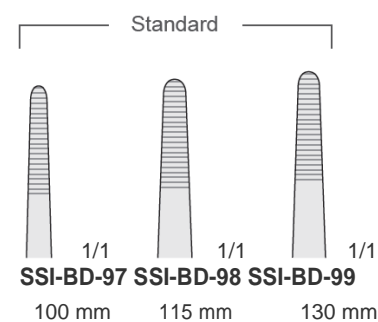
SSI-BD-10/SSI-BD-76



SSI-BD-10 SSI-BD-75 SSI-BD-76
145 mm 145 mm 200 mm



SSI-BD-97/SSI-BD-99

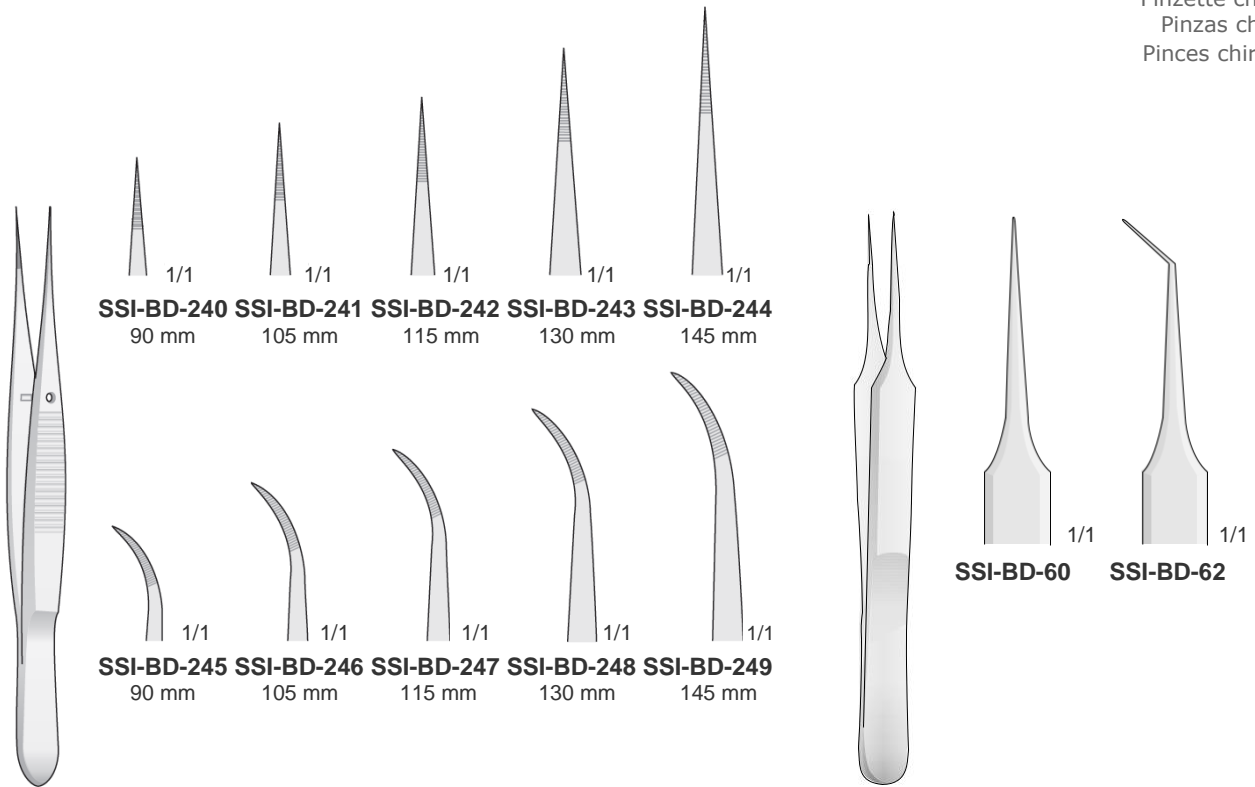


SSI-BD-97 SSI-BD-98 SSI-BD-99
100 mm 115 mm 130 mm

Email: sheffieldsurgicalinstruments@gmail.com
 Web: www.sheffieldsurgicalinst.com

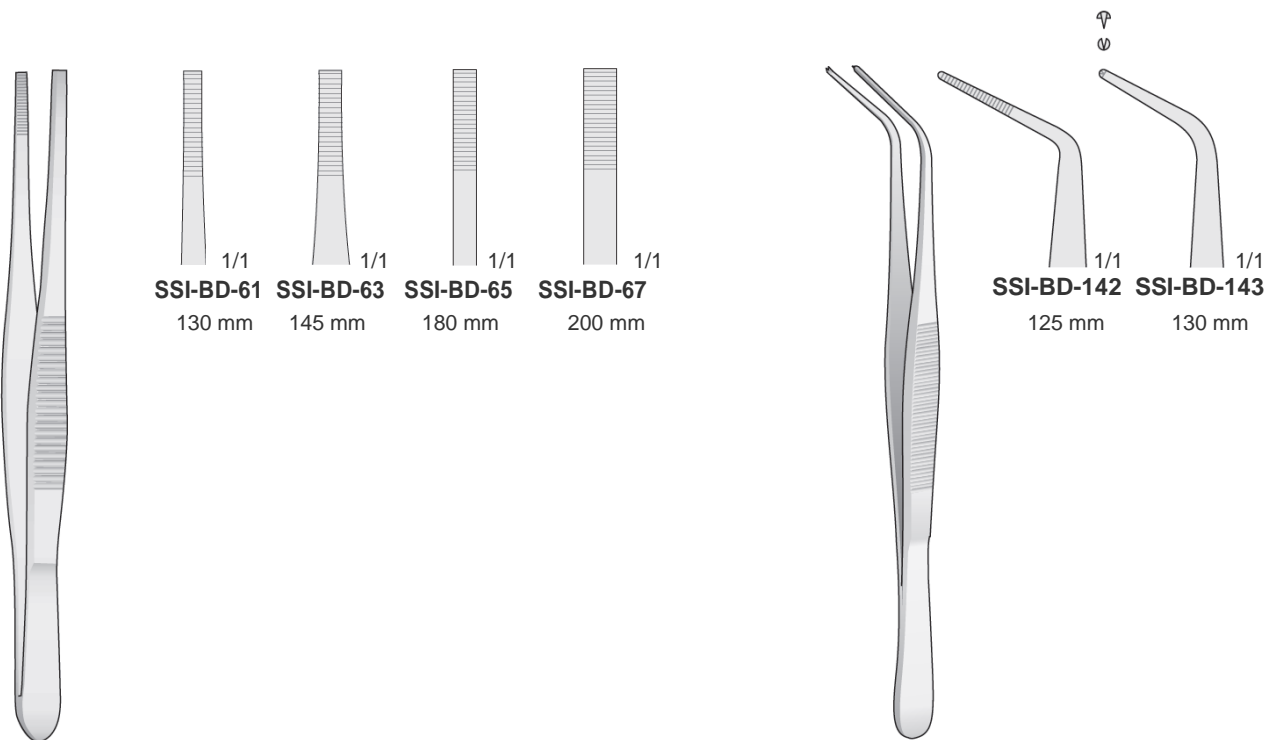


chirurgische Pinzetten
 Tissue Forceps
 Pinzette chirurgiche
 Pinzas quirúrgicas
 Pincas chirurgicales



SSI-BD-240/SSI-BD-249

SSI-BD-60/SSI-BD-62
110 mm

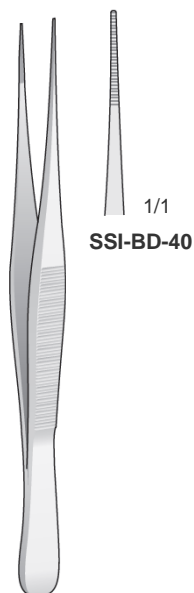


STILLE
SSI-BD-61/SSI-BD-67

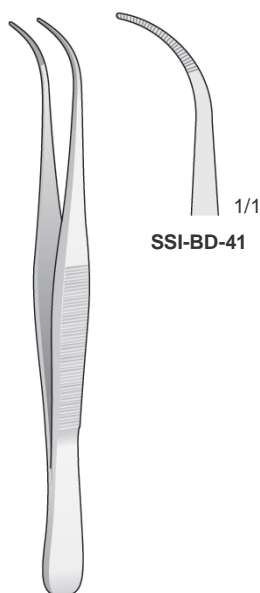
SSI-BD-142/SSI-BD-143

Email: sheffieldsurgicalinstruments@gmail.com
 Web: www.sheffieldsurgicalinst.com

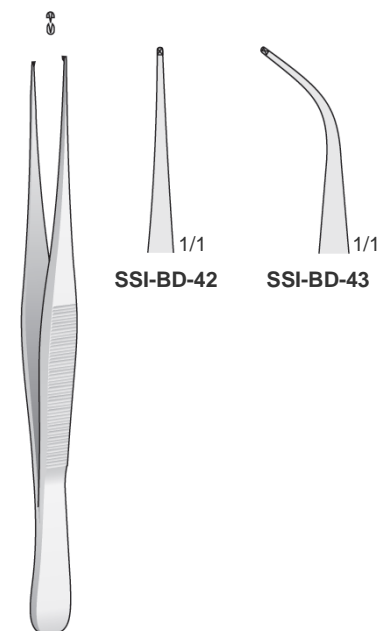
Chirurgische Pinzetten
 Tissue Forceps
 Pinzette chirurgiche
 Pinzas chirùrgicas
 Pincas chirurgicales



SSI-BD-40
110 mm



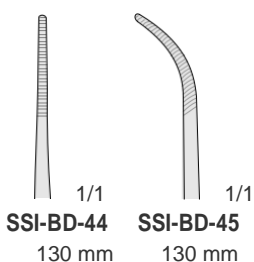
SSI-BD-41
110 mm



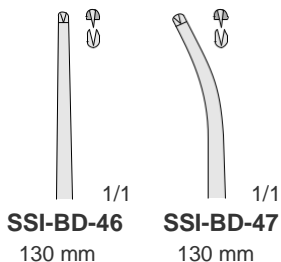
SSI-BD-42/SSI-BD-43
110 mm



SEMKEN
SSI-BD-44/SSI-BD-45
130 mm



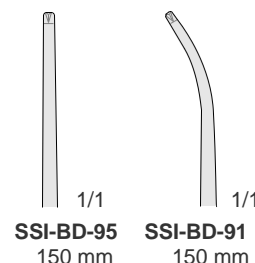
SEMKEN
SSI-BD-46/SSI-BD-47
130 mm



1x2 Zähne
 1x2 Teeth
 1x2 Denti
 1x2 Dents
 1x2 Dientes



SEMKEN
SSI-BD-91/SSI-BD-95
150 mm

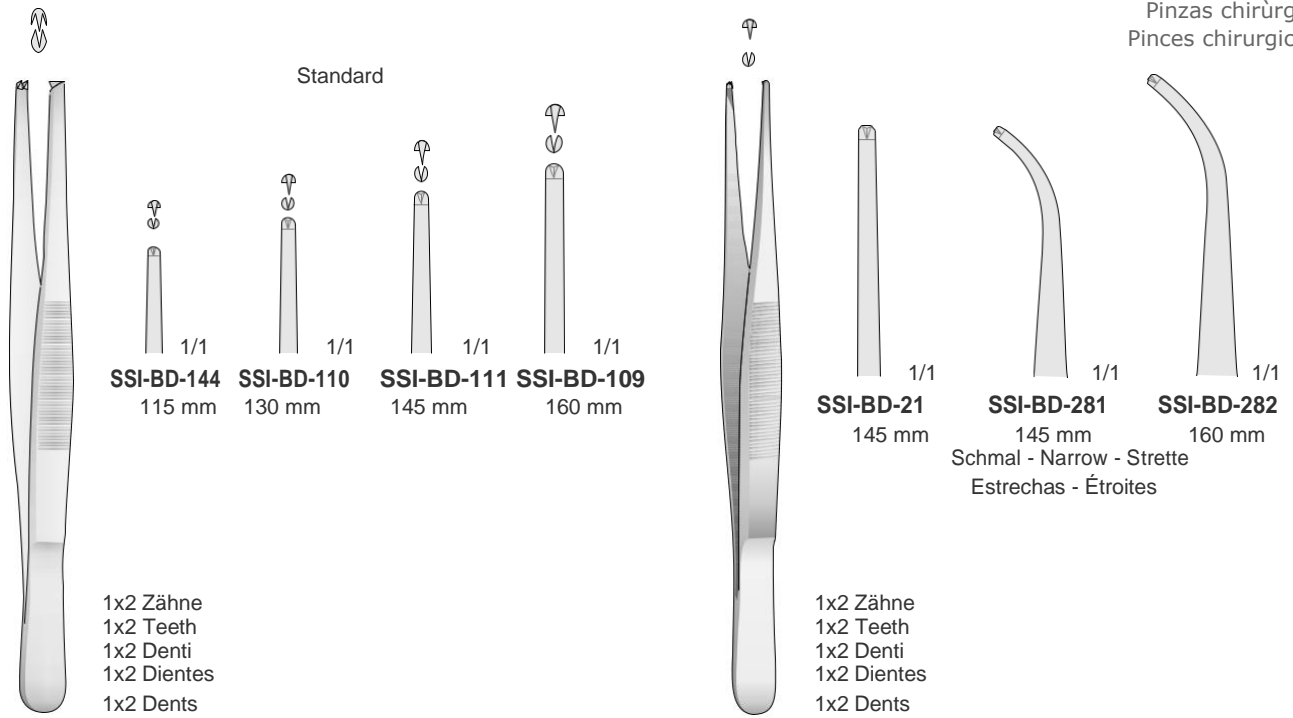


1x2 Zähne
 1x2 Teeth
 1x2 Denti
 1x2 Dents
 1x2 Dientes

Email: sheffieldsurgicalinstruments@gmail.com
 Web: www.sheffieldsurgicalinst.com



Chirurgische Pinzetten
Tissue Forceps
Pinzette chirurgiche
Pinzas chirùrgicas
Pincas chirurgicales



SSI-BD-109/SSI-BD-144

SSI-BD-21/SSI-BD-282

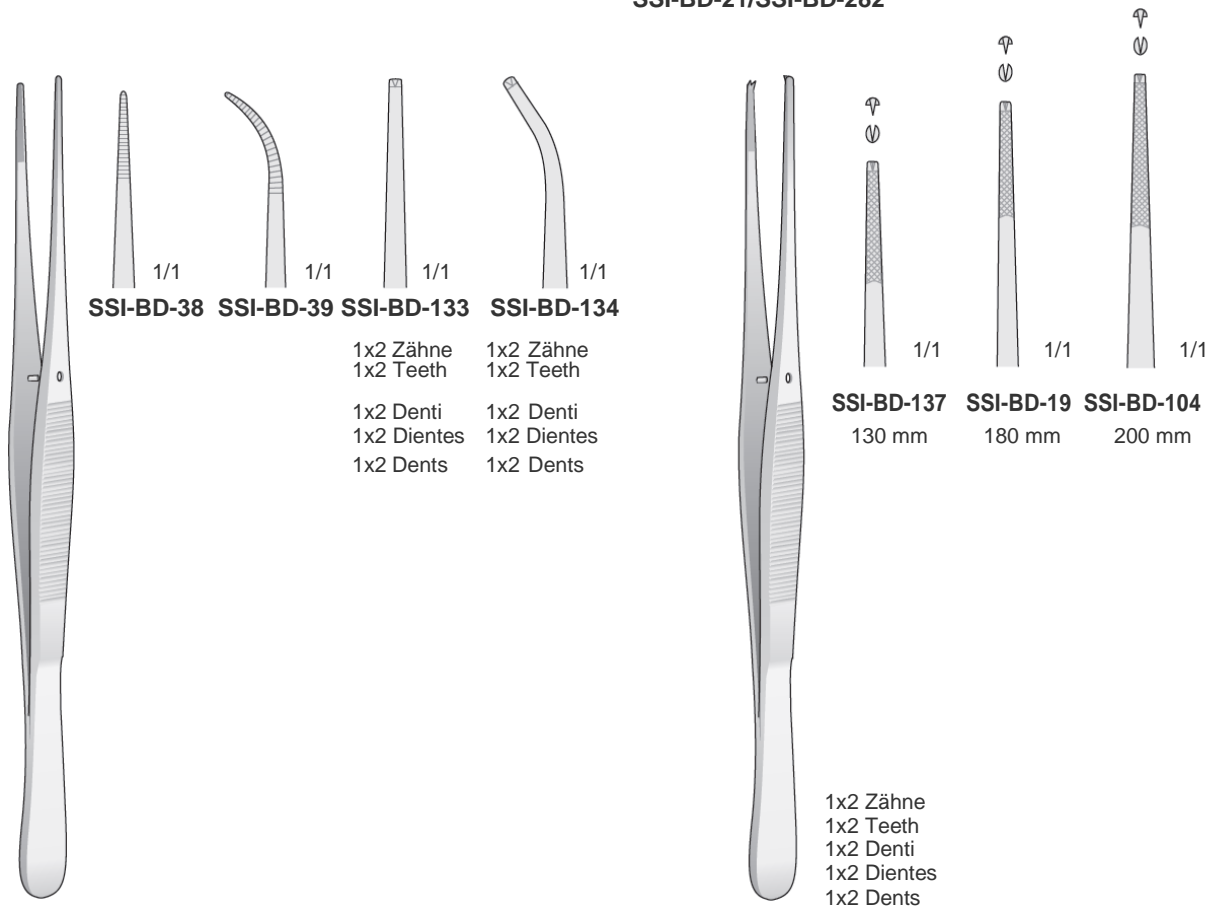


Fig.17
SSI-BD-38/SSI-BD-134
200 mm

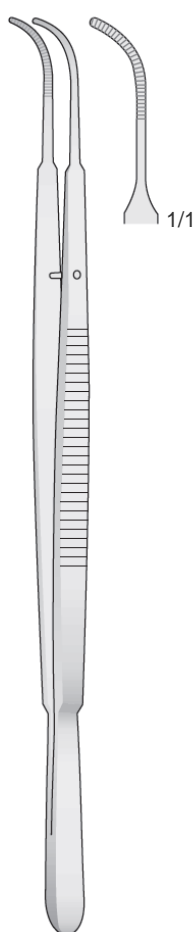
SSI-BD-19/SSI-BD-137

Email: sheffieldsurgicalinstruments@gmail.com
Web: www.sheffieldsurgicalinst.com

Chirurgische Pinzetten
 Tissue Forceps
 Pinzette chirurgiche
 Pinzas quirùrgicas
 Pincas quirurgicales



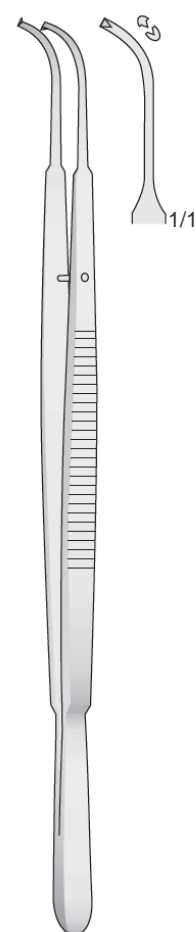
**GERALD
 SSI-MF-101**
 180 mm



**GERALD
 SSI-MF-102**
 180 mm



**GERALD
 SSI-MF-103**
 180 mm



**GERALD
 SSI-MF-104**
 180 mm



**GERALD-BROWN
 SSI-MF-105**
 180 mm

Email: sheffieldsurgicalinstruments@gmail.com
 Web: www.sheffieldsurgicalinst.com

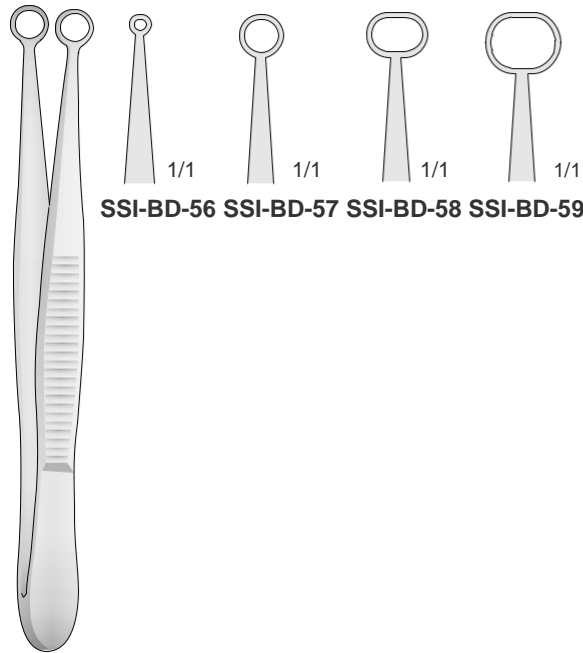


Chirurgische Pinzetten
Tissue Forceps

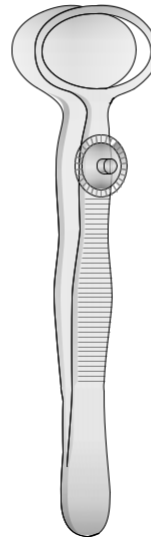
Pinzette chirurgiche
Pinzas quirúrgicas
Pinces quirúrgicas

Membrane Forceps

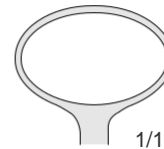
with delicate Ring tip



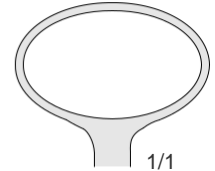
SSI-BD-56 SSI-BD-57 SSI-BD-58 SSI-BD-59



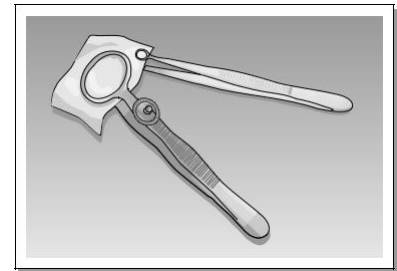
DESMARRES
SSI-BD-130/SSI-BD-131
90 mm



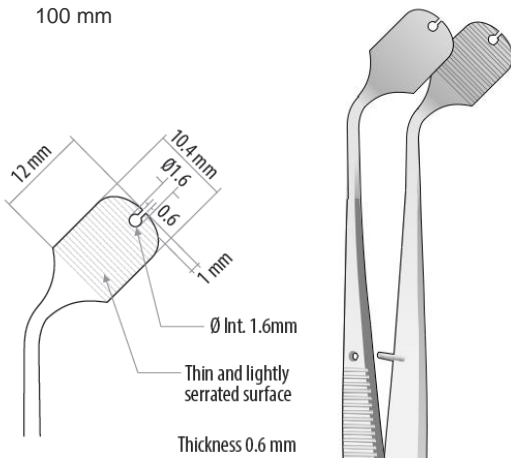
SSI-BD-130
20 mm



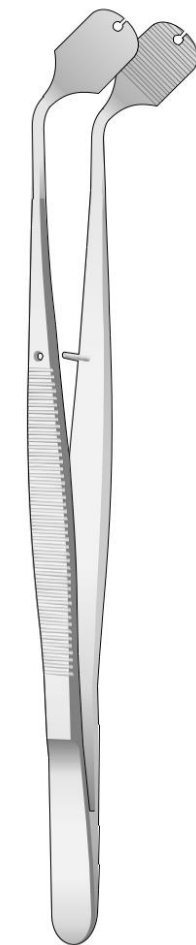
SSI-BD-131
26 mm



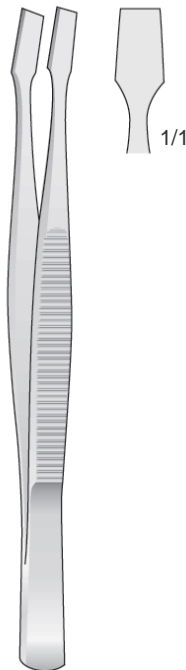
SSI-BD-56/SSI-BD-59
100 mm



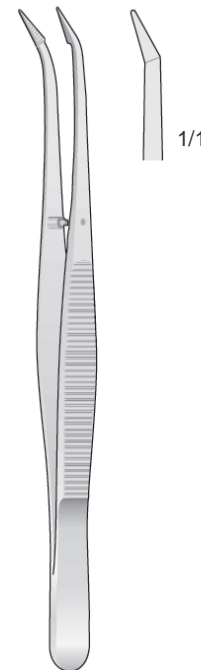
Pinzetten zum Halten Membranen
Membrane Holding forceps
Pinza per fissaggio membrane
Pinza para sostener membranas
Pince pour le maintien membranes



SSI-TASO-9
150 mm



KÜHNE
SSI-ES-44
105 mm

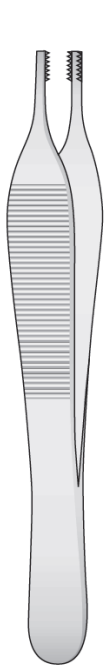


BARRAQUER
SSI-ES-65
105 mm

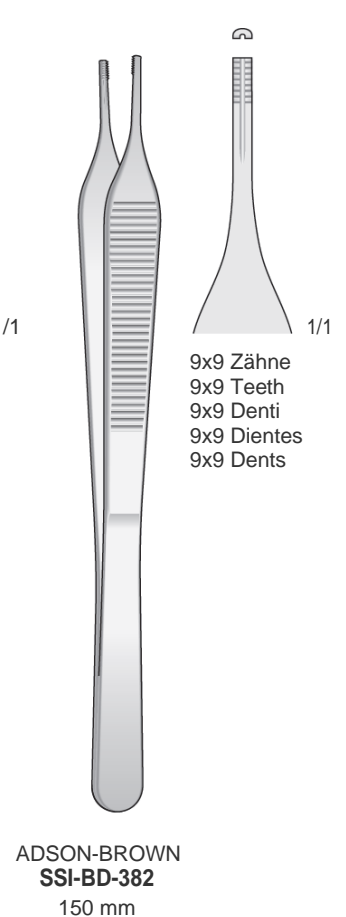
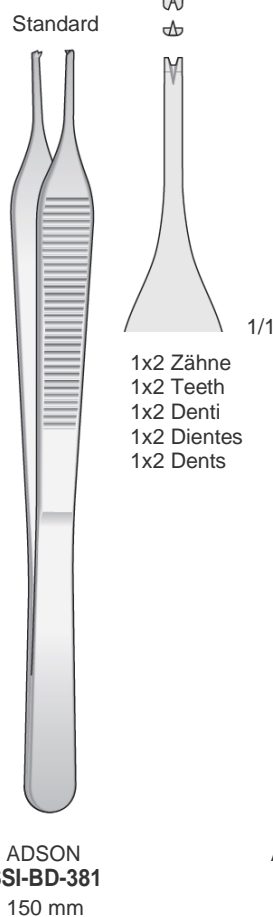
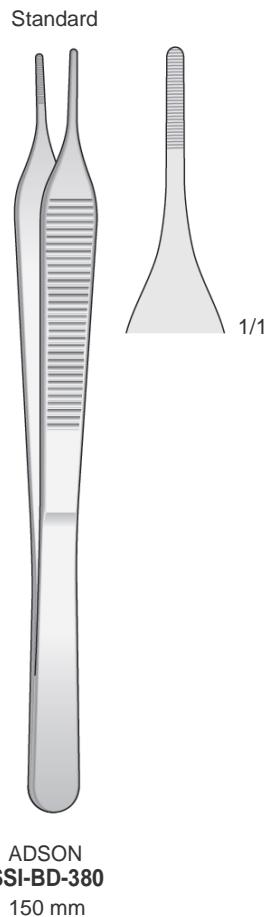
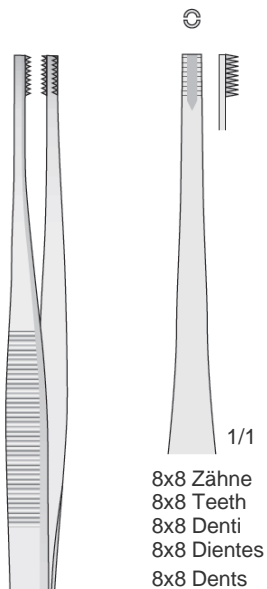
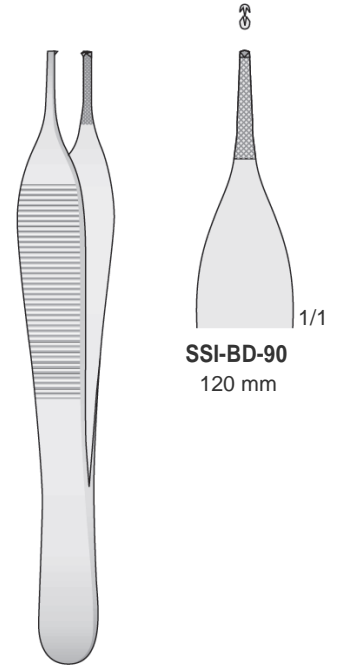
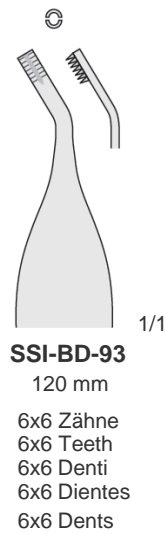
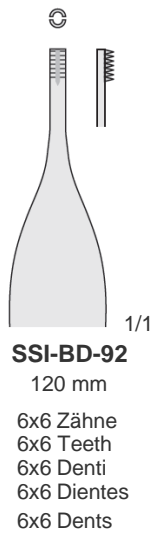
Email: sheffieldsurgicalinstruments@gmail.com
Web: www.sheffieldsurgicalinst.com



Chirurgische Pinzetten
Tissue Forceps
Pinzette chirurgische
Pinzas quirúrgicas
Pincas quirurgicalas



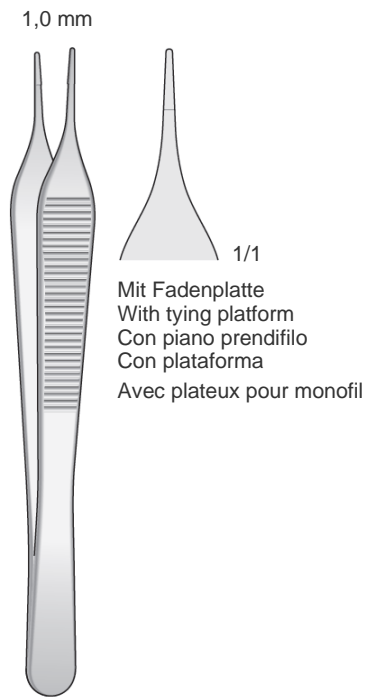
ADSON-BROWN
SSI-BD-92/SSI-BD-141
120 mm



Email: sheffieldsurgicalinstruments@gmail.com
Web: www.sheffieldsurgicalinst.com

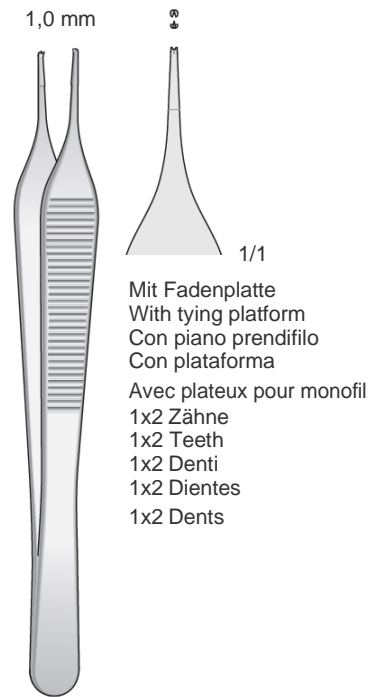


Chirurgische Pinzetten
Tissue Forceps
Pinzette chirurgiche
Pinzas chirùgicas
Pincas chirurgicales



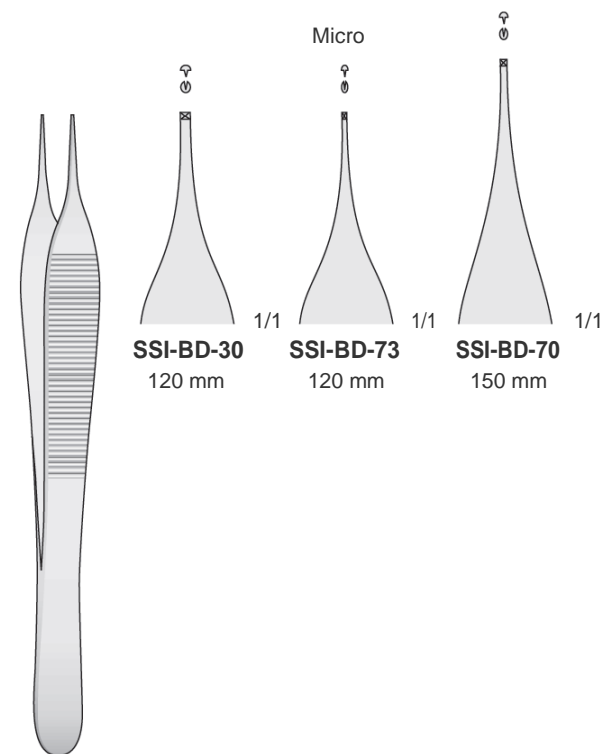
ADSON
SSI-BD-370
120 mm

Mit Fadenplatte
With tying platform
Con piano prendifilo
Con plataforma
Avec plateaux pour monofil



ADSON
SSI-BD-371
120 mm

Mit Fadenplatte
With tying platform
Con piano prendifilo
Con plataforma
Avec plateaux pour monofil
1x2 Zähne
1x2 Teeth
1x2 Denti
1x2 Dientes
1x2 Dents

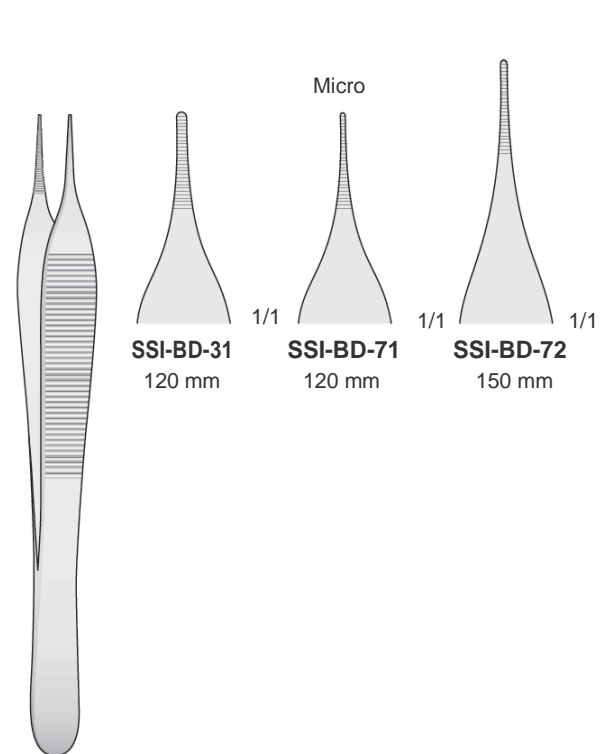


ADSON
SSI-BD-30/SSI-BD-73

SSI-BD-30
120 mm

SSI-BD-73
120 mm

SSI-BD-70
150 mm



ADSON
SSI-BD-31/SSI-BD-72

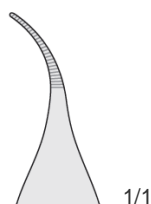
SSI-BD-31
120 mm

SSI-BD-71
120 mm

SSI-BD-72
150 mm

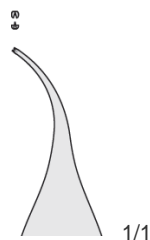
Email: sheffieldsurgicalinstruments@gmail.com
Web: www.sheffieldsurgicalinst.com

Chirurgische Pinzetten - Anatomische Pinzetten
 Tissue Forceps - Dressing forceps
 Pinzette chirurgiche - Pinzette anatomiche
 Pinzas quirúrgicas - Pinzas de diseccion
 Pincas quirurgicales - Pincas anatomiques



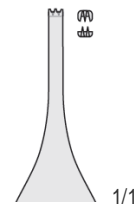
Extra fein
 Extra fine
 Extra fine
 Extra finas
 Extra fins
 Gebogen
 Curved
 Curva
 Curvas
 Courbé

**MICRO-ADSON
 SSI-BD-372**
 120 mm



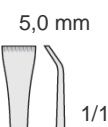
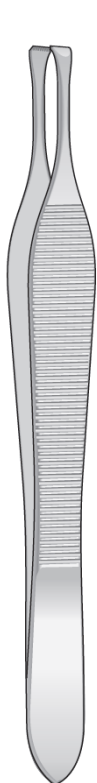
Extra fein
 Extra fine
 Extra fine
 Extra finas
 Extra fins
 Gebogen
 Curved
 Curva
 Curvas
 Courbé
 1x2 Zähne
 1x2 Teeth
 1x2 Denti
 1x2 Dientes
 1x2 Dents

**MICRO-ADSON
 SSI-BD-373**
 120 mm



2x3 Zähne
 2x3 Teeth
 2x3 Denti
 2x3 Dientes
 2x3 Dents

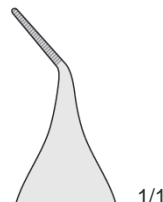
**ADSON
 SSI-BD-377**
 120 mm



**BEASLEY-BABCOCK
 SSI-BD-51**
 120 mm

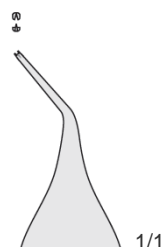


**GRAEFE
 SSI-BD-135**
 110 mm



Gerieft
 Serrated
 Zigrinata
 Estriada
 Striée
 Abgewinkelt
 Angled
 Angolata
 Angulada
 Coudée en haut

**ADSON
 SSI-BD-378**
 120 mm



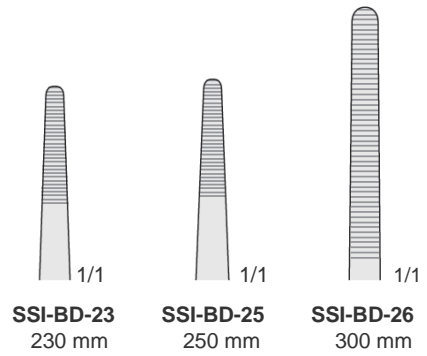
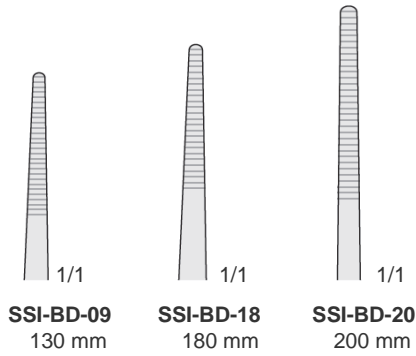
1x2 Zähne
 1x2 Teeth
 1x2 Denti
 1x2 Dientes
 1x2 Dents
 Abgewinkelt
 Angled
 Angolata
 Angulada
 Coudée en haut

**ADSON
 SSI-BD-379**
 120 mm

Email: sheffieldsurgicalinstruments@gmail.com
 Web: www.sheffieldsurgicalinst.com

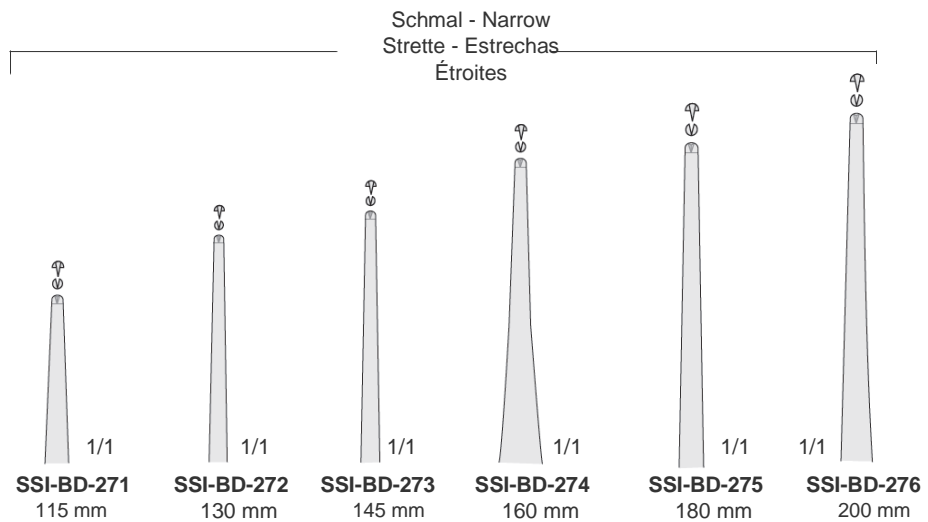


Chirurgische Pinzetten - Anatomische
 Pinzetten Tissue Forceps - Dressing forceps
 Pinzette chirurgiche - Pinzette anatomiche
 Pinzas quirùrgicas - Pinzas de diseccion Pincas
 chirurgicales - Pincas anatomicas



SSI-BD-09/SSI-BD-20

SSI-BD-23/SSI-BD-26

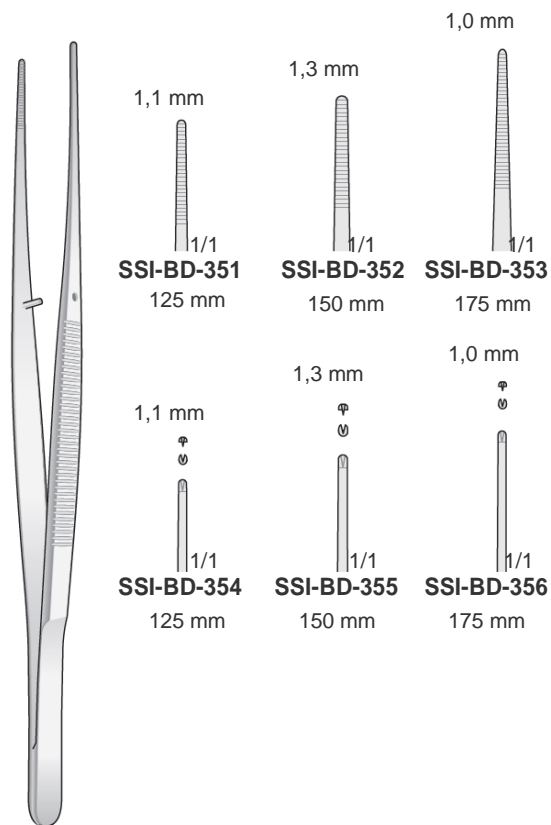
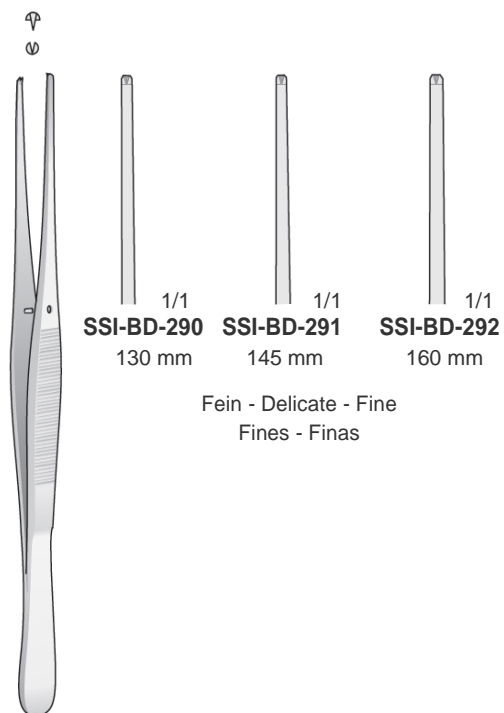


1x2 Zähne
 1x2 Teeth
 1x2 Denti
 1x2 Dientes
 1x2 Dents

SSI-BD-271/SSI-BD-276

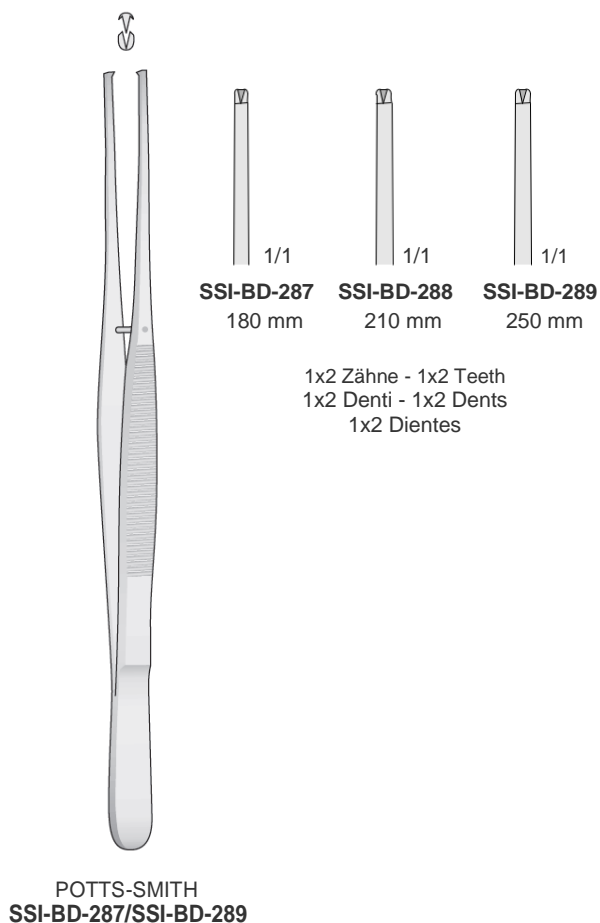
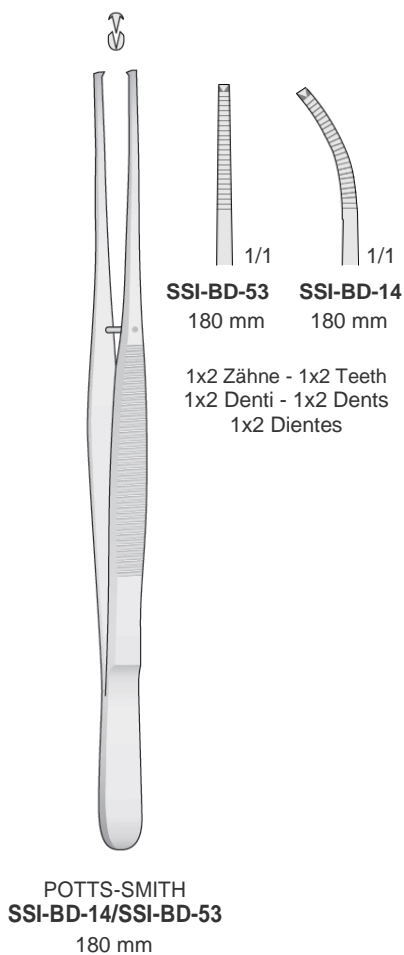
Email: sheffieldsurgicalinstruments@gmail.com
 Web: www.sheffieldsurgicalinst.com

Chirurgische Pinzetten
Tissue Forceps
Pinzette chirurgiche
Pinzas quirúrgicas
Pincas quirúrgicas



SSI-BD-290/SSI-BD-292

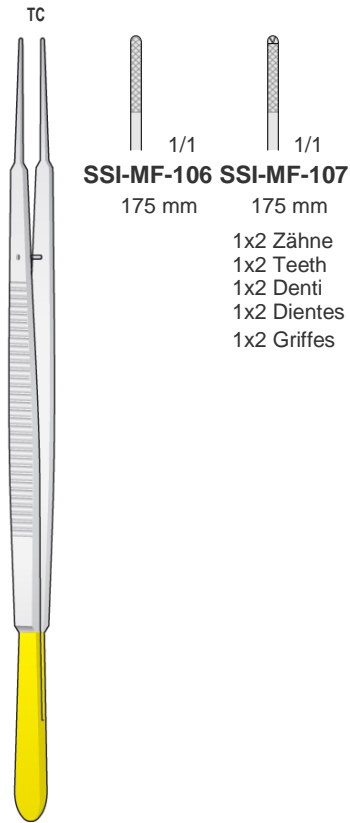
SSI-BD-351/SSI-BD-356



Email: sheffieldsurgicalinstruments@gmail.com
Web: www.sheffieldsurgicalinst.com

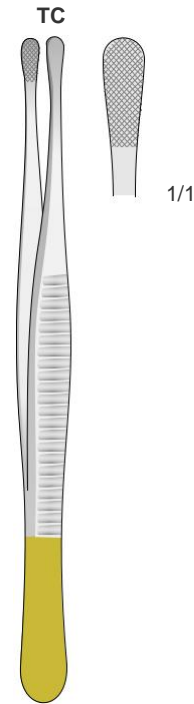


Chirurgische Pinzetten, Atraumatische Pinzetten
 Tissue Forceps, Non-traumatic Forceps
 Pinzette chirurgiche, Pinzette atraumatiche
 Pinzas quirùrgicas, Pinzas atraumàticas
 Pincas chirurgicales, Pincas atraumatiques

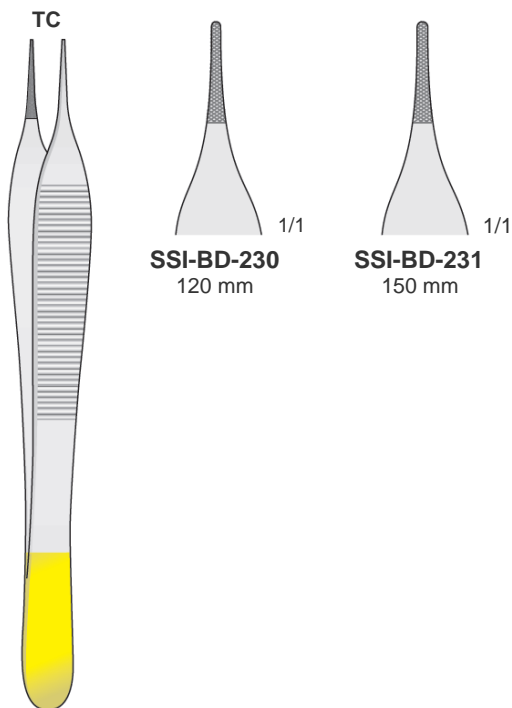


GERALD
SSI-MF-106/SSI-MF-107
 175 mm

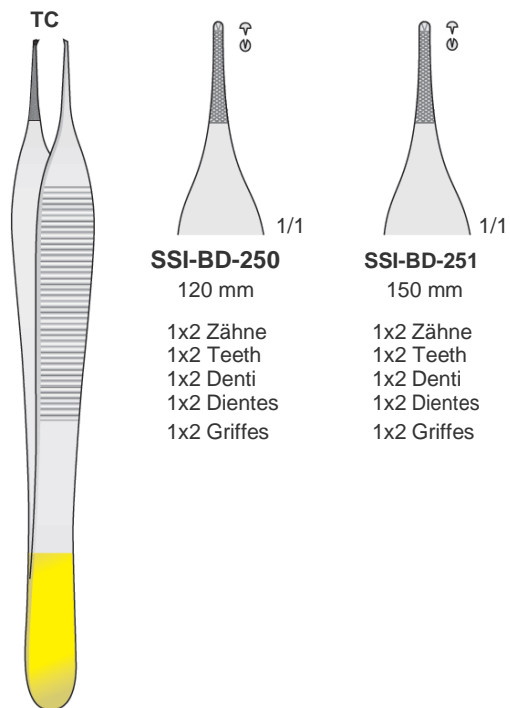
Tungsten-Carbide Inserts Mit
 Hartmetalleinsätzen Plaquettes en
 carbure de tungstène Plaquetas de
 carburo de tungsteno Inserti in
 carburo di tungsteno



WANGENSTEEN
SSI-BD-232
 150 mm



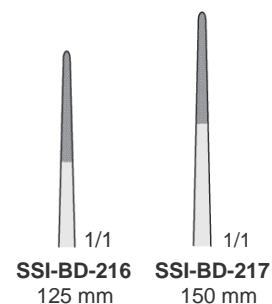
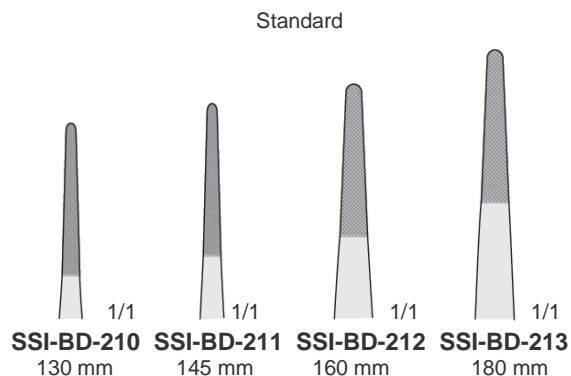
ADSON
SSI-BD-230/SSI-BD-231



ADSON
SSI-BD-250/SSI-BD-251

Email: sheffieldsurgicalinstruments@gmail.com
 Web: www.sheffieldsurgicalinst.com

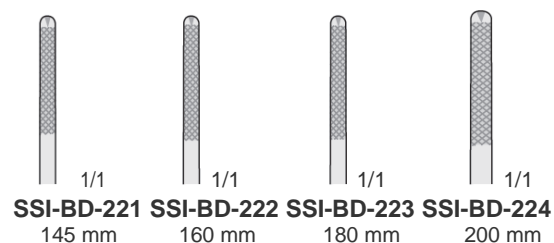
Chirurgische Pinzetten, Atraumatische Pinzetten
 Tissue Forceps, Non-traumatic Forceps
 Pinzette chirurgiche, Pinzette atraumatiche
 Pinzas quirùrgicas, Pinzas atraumáticas
 Pincas chirurgicales, Pincas atraumatiques



Tungsten-Carbide Inserts
 Mit Hartmetalleinsätzen
 Plaquettes en carbure de tungstène
 Plaquetas de carburo de tungsten
 Inserti in carburo di tungsteno

SEMKEN
 SSI-BD-216/SSI-BD-217

SSI-BD-210/SSI-BD-213



Mikroprofil
 Micro profile
 Profilo micro
 Perfil micro
 Profil micro
 2.0 mm

SSI-BD-221/SSI-BD-224

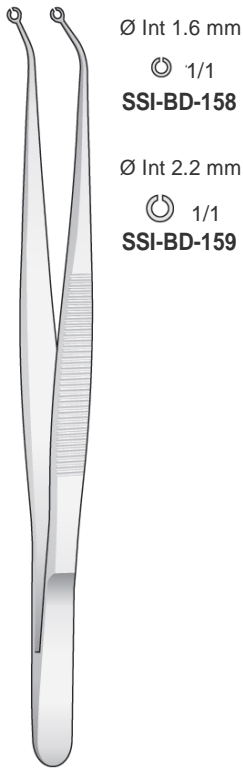
DE BAKEY
 SSI-BD-267
 160 mm

Email: sheffieldsurgicalinstruments@gmail.com
 Web: www.sheffieldsurgicalinst.com



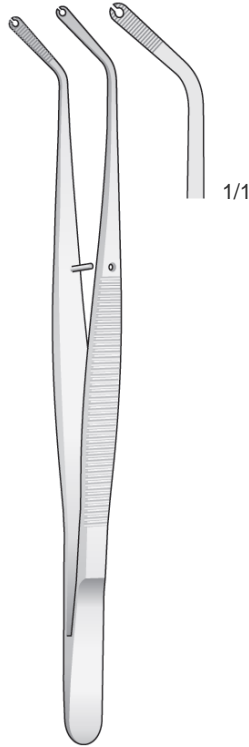
Naht-und Membranpinzette - Suture and membrane Forceps
 Pinzette per suture e membrane - Pinzas para suturas y membranas
 Pincettes à suture et à membrane

Pinzetten
 Forceps
 Pinzette
 Pinzas
 Pincés

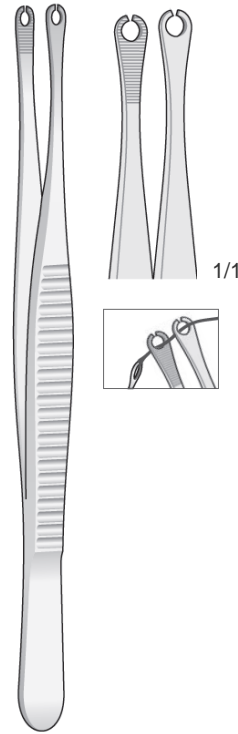


Ø Int 1.6 mm
 1/1
SSI-BD-158
 Ø Int 2.2 mm
 1/1
SSI-BD-159

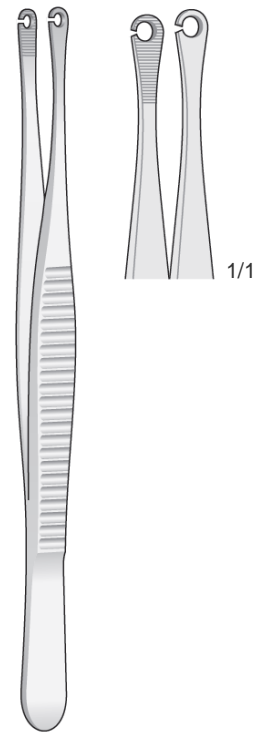
SSI-BD-158/SSI-BD-159
 160 mm



CORN
SSI-DA-07
 150 mm

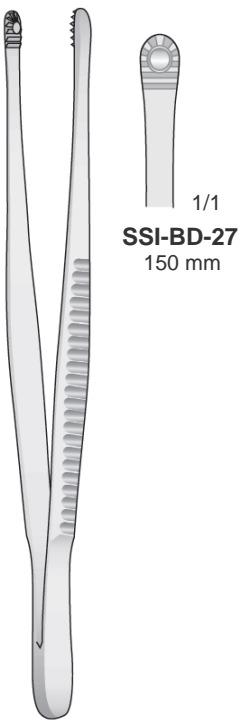


SSI-DA-06
 150 mm



SSI-DA-08
 150 mm

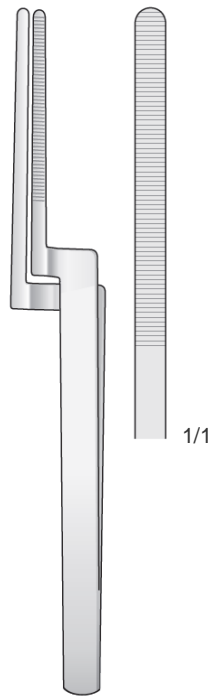
Artikulationspapier-Pinzetten - Articulating Paper Forceps
 Pinza per carta articolazione - Pinzas para papel de articular
 Pince pour papier à articuler



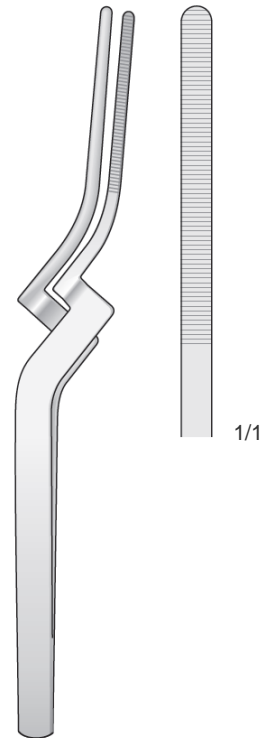
SSI-BD-27
 150 mm

SSI-BD-175
 200 mm

RUSSIAN
SSI-BD-27/SSI-BD-175



MILLER
SSI-DR-78
 145 mm

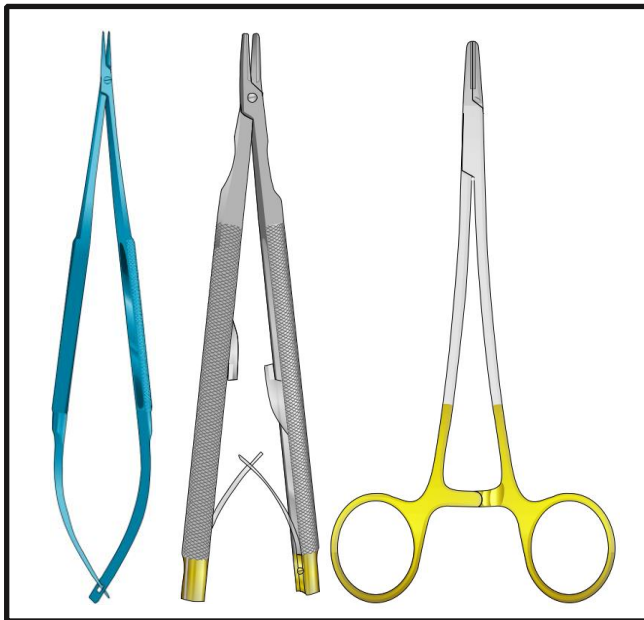


MILLER
SSI-DR-80
 160 mm

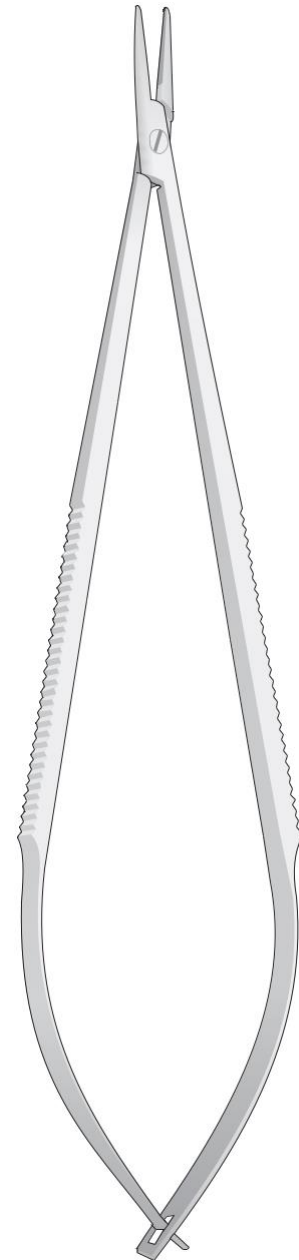
Email: sheffieldsurgicalinstruments@gmail.com
 Web: www.sheffieldsurgicalinst.com

Needle Holders

Nadelhalter
Porte-aiguilles
Porta-agujas
Port'aghi



Sheffield Surgical is highly experienced Manufacturer & exporter of high quality Dental Instruments and also in the field of General Surgery, Bone Surgery an Orthopedic Instruments.

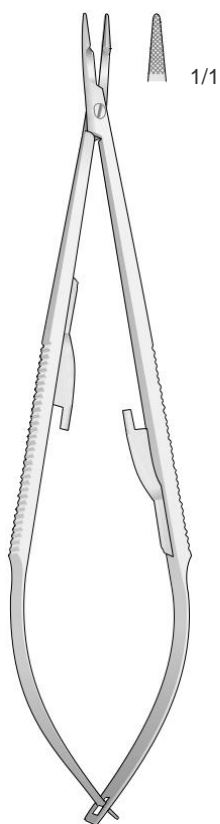


Email: sheffieldsurgicalinstruments@gmail.com
Web: www.sheffieldsurgicalinst.com

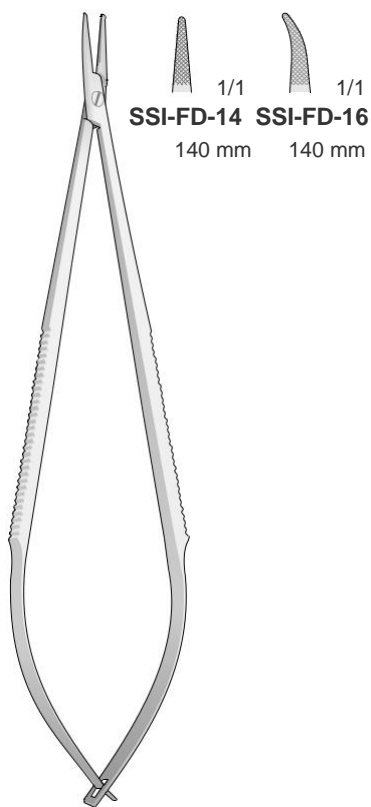
Nadelhalter
Needle Holders
Port'aghi
Portaagujas
Porte aiguilles

Mit Scheren
With Scissor
Con forbice
Con tijeras
Avec ciseaux

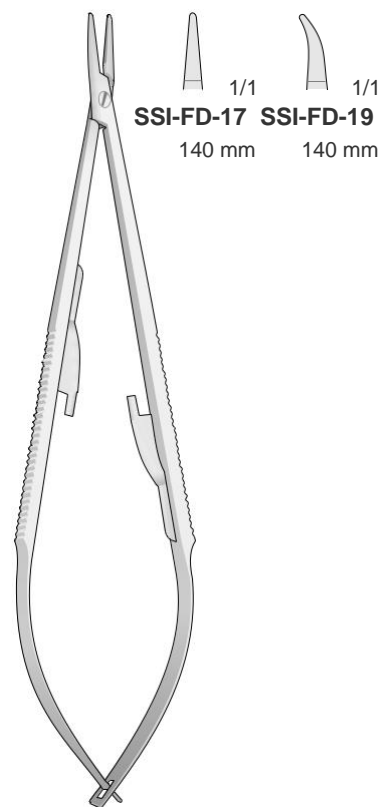
Glattes Maul
Smooth Jaw
Morso liscio
Mandíbula lisa
Mors lisse



SSI-FD-26
140 mm



SSI-FD-14/SSI-FD-16
140 mm



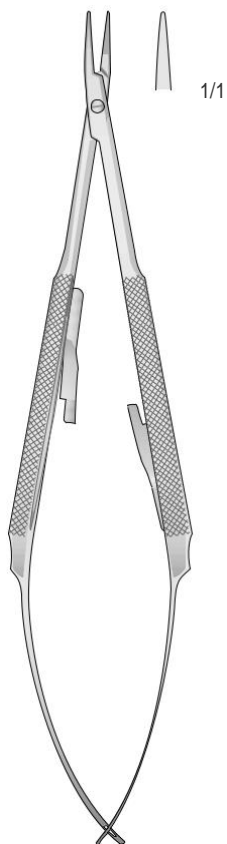
CASTROVIEJO
SSI-FD-17/SSI-FD-19
140 mm

Email: sheffieldsurgicalinstruments@gmail.com
Web: www.sheffieldsurgicalinst.com

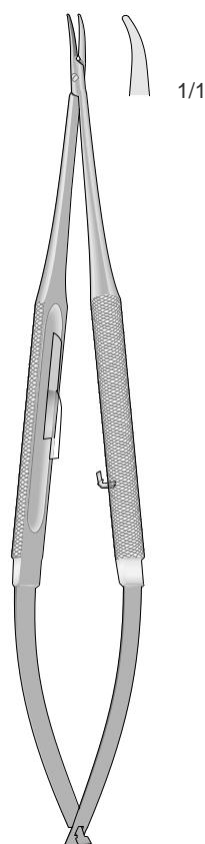
Mit Locking-System
With Locking System (stop)
Con sistema di bloccaggio
Con sistema de bloqueo
Avec système de verrouillage

Glattes Maul
Smooth Jaw
Morso liscio
Mandíbula lisa
Mors lisse

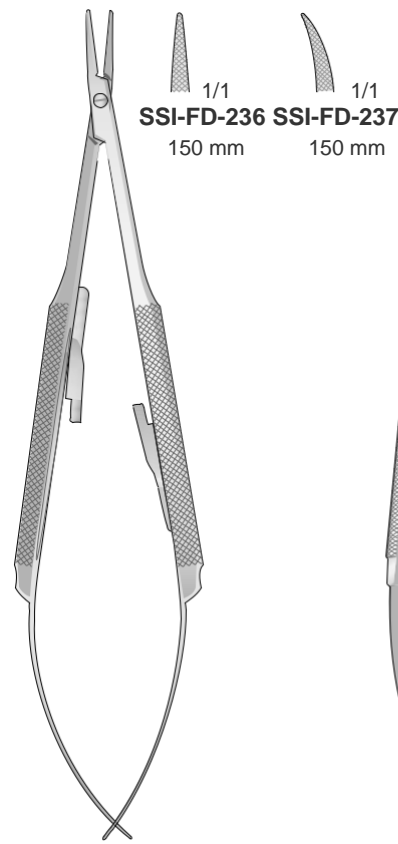
Feingerieftes Maul
Fine serrated jaws
Morso zigrinato fine
Mandíbula estriada fina
Mors strié fin



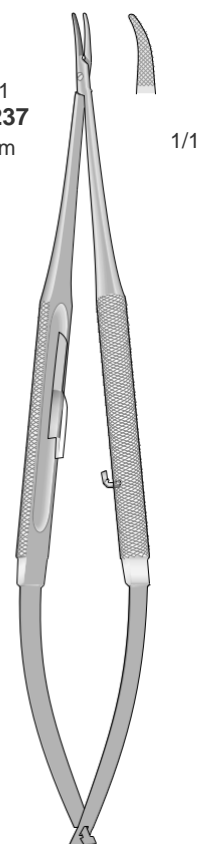
BARRAQUER
SSI-FD-216
150 mm



BARRAQUER
SSI-FD-217
150 mm



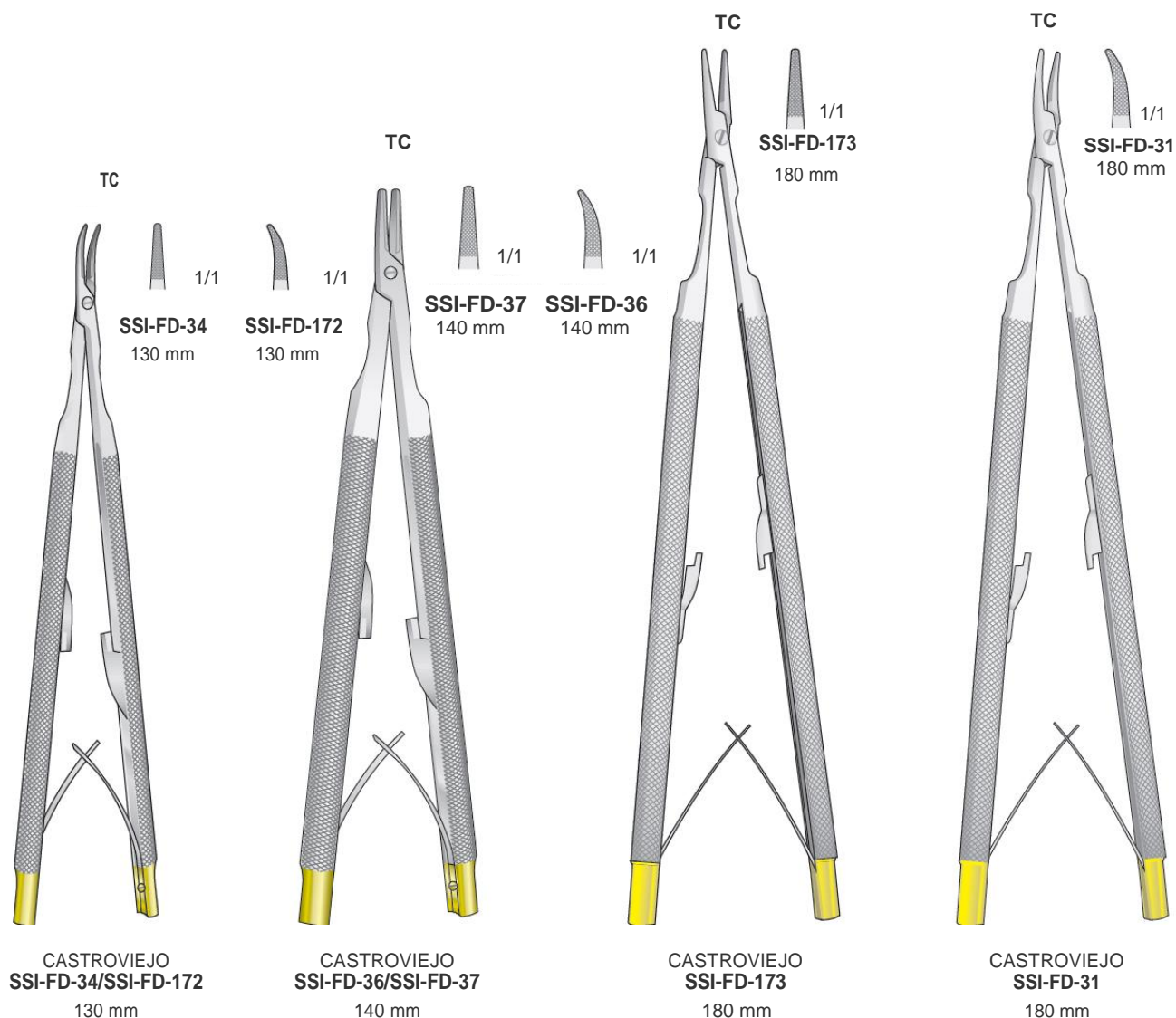
BARRAQUER
SSI-FD-236/SSI-FD-237
150 mm



BARRAQUER
SSI-FD-24
150 mm

Nadelhalter
Needle Holders
Port'aghi
Portaagujas
Porte aiguilles

Tungsten-Carbide Inserts
Mit Hartmetalleinsätzen
Plaquettes en carbure de tungstène
Plaquetas de carburo de tungsteno
Inserti in carburo di tungsteno

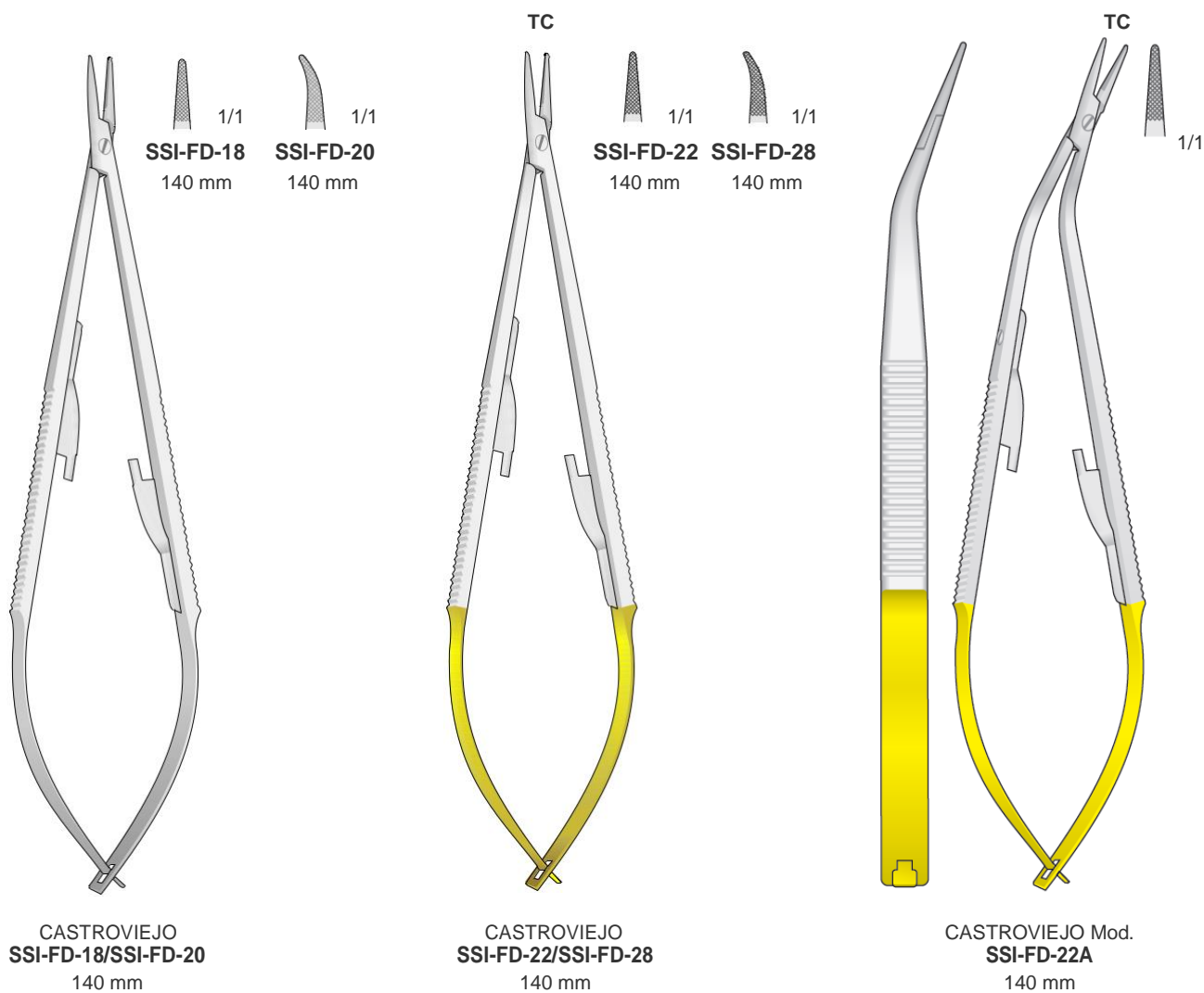


Email: sheffieldsurgicalinstruments@gmail.com
Web: www.sheffieldsurgicalinst.com



Nadelhalter
Needle Holders
Port'aghi
Portaagujas
Porte aiguilles

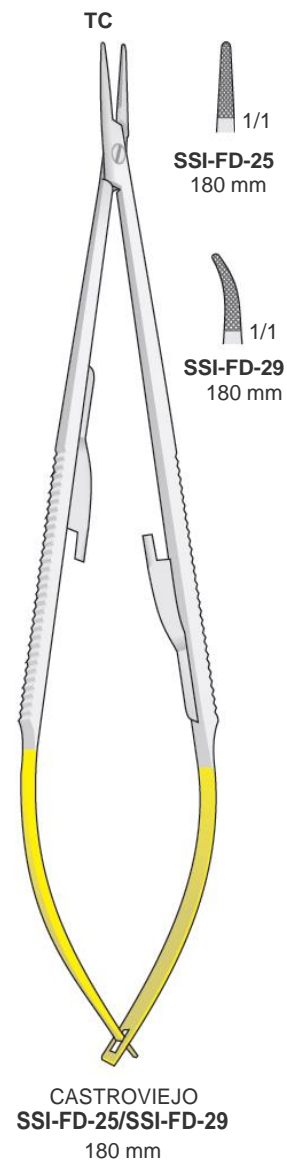
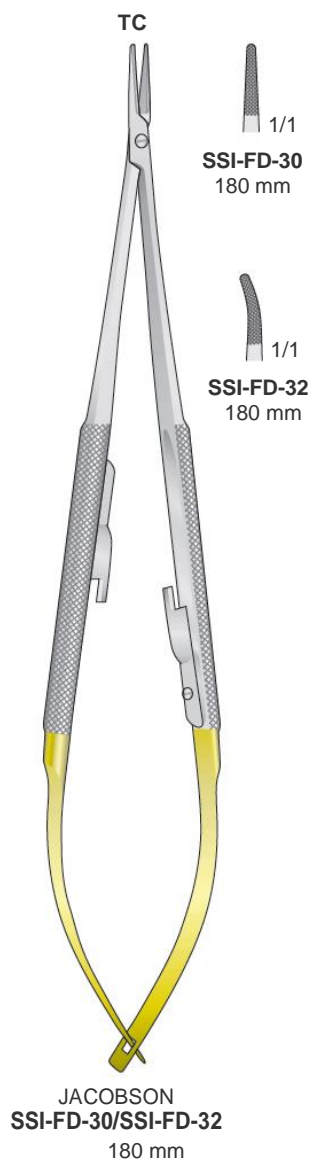
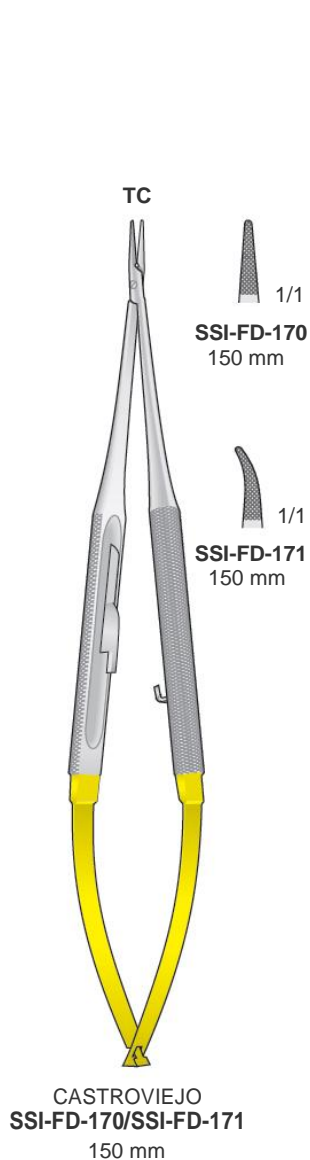
Tungsten-Carbide Inserts
Mit Hartmetalleinsätzen
Plaquettes en carbure de tungstène
Plaquetas de carburo de tungsteno
Inserti in carburo di tungsteno



Email: sheffieldsurgicalinstruments@gmail.com
Web: www.sheffieldsurgicalinst.com

Nadelhalter
Needle Holders
Port'aghi
Portaagujas
Porte aiguilles

Tungsten-Carbide Inserts
Mit Hartmetalleinsätzen
Plaquettes en carbure de tungstène
Plaquetas de carburo de tungsteno
Inserti in carburo di tungsteno



Email: sheffieldsurgicalinstruments@gmail.com
Web: www.sheffieldsurgicalinst.com

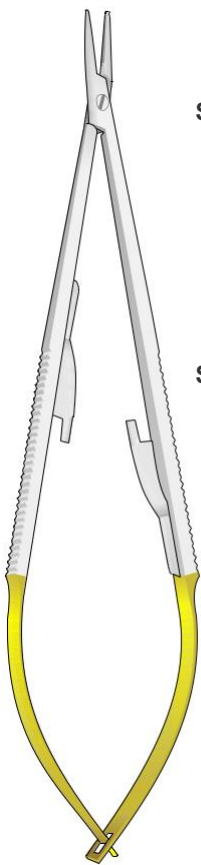


Nadelhalter
Needle Holders
Port'aghi
Portaagujas
Porte aiguilles

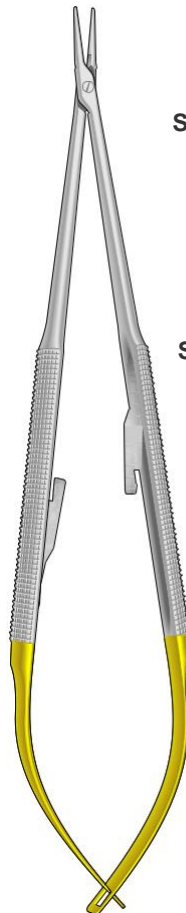
**Tungsten-Carbide Inserts
Mit Hartmetalleinsätzen**
Plaquettes en carbure de tungstène
Plaquetas de carburo de tungsteno
Inserti in carburo di tungsteno

Glattes Maul
Smooth jaws
Con morso liscio
Mandibula lisa
A' mors lisse

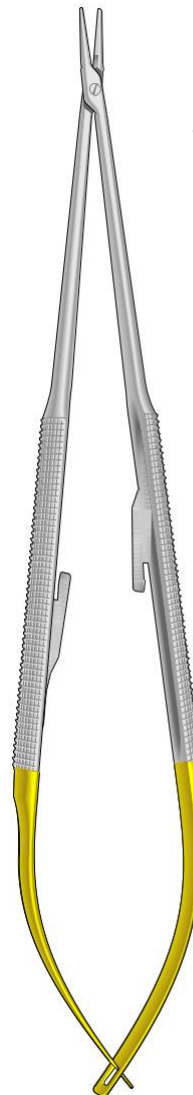
TC



CASTROVIEJO
SSI-FD-21/SSI-FD-23
140 mm



SSI-FD-599/SSI-FD-600
150 mm



SSI-FD-601/SSI-FD-602
180 mm

Diamond Tip
Diamantiert
Punta diamantata
Punta de diamante
Pointe de diamant

Email: sheffieldsurgicalinstruments@gmail.com
Web: www.sheffieldsurgicalinst.com

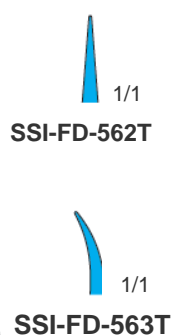
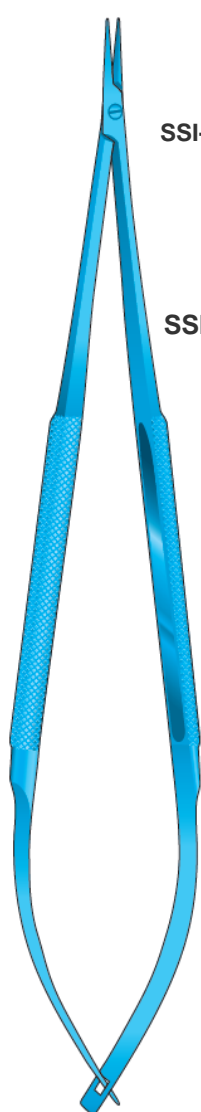
Mikro Nadelhalter - Mikro Scheren
 Micro Needle Holders - Micro Scissors
 Micro Port'aghi - Micro Forbici
 Micro Portaaguja - Micro Tijeras
 Micro Porte aiguilles - Micro Ciseaux

Titanium
 Titan
 Titane
 Titanio
 Titanio

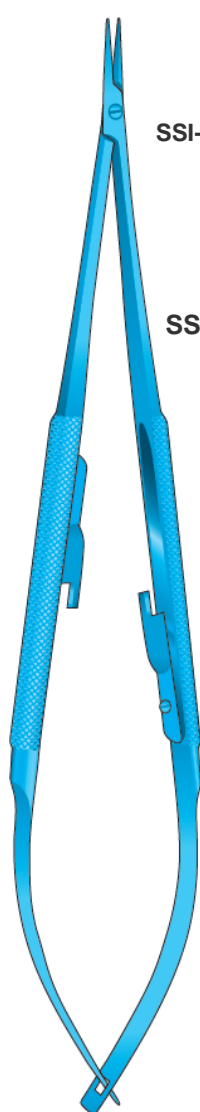
Rund-Griffe Ø 8 mm
 Round handle Ø 8 mm
 Manico rotondo Ø 8 mm
 Mango redondo Ø 8 mm
 Manche rond Ø 8 mm

Mikro Nadelhalter
 Micro Needle Holders
 Micro port'aghi
 Micro portaaguja
 Micro porte aiguilles

Mikro Scheren
 Micro Scissors
 Micro forbici
 Micro tijeras
 Micro ciseaux

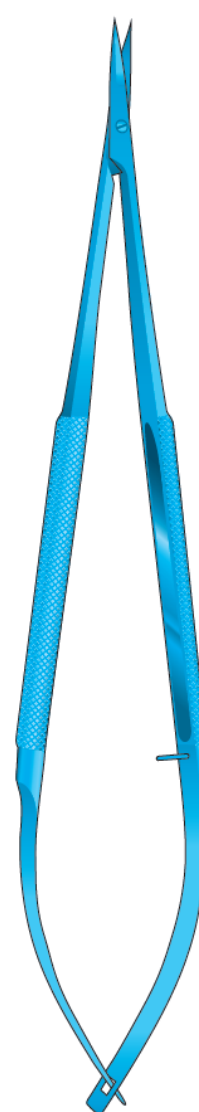


SSI-FD-562T/SSI-FD-563T
 180 mm



Mit Sperre
 With Lock
 Con arresto
 Con cierre
 Avec Arrêt

SSI-FD-574T/SSI-FD-575T
 180 mm



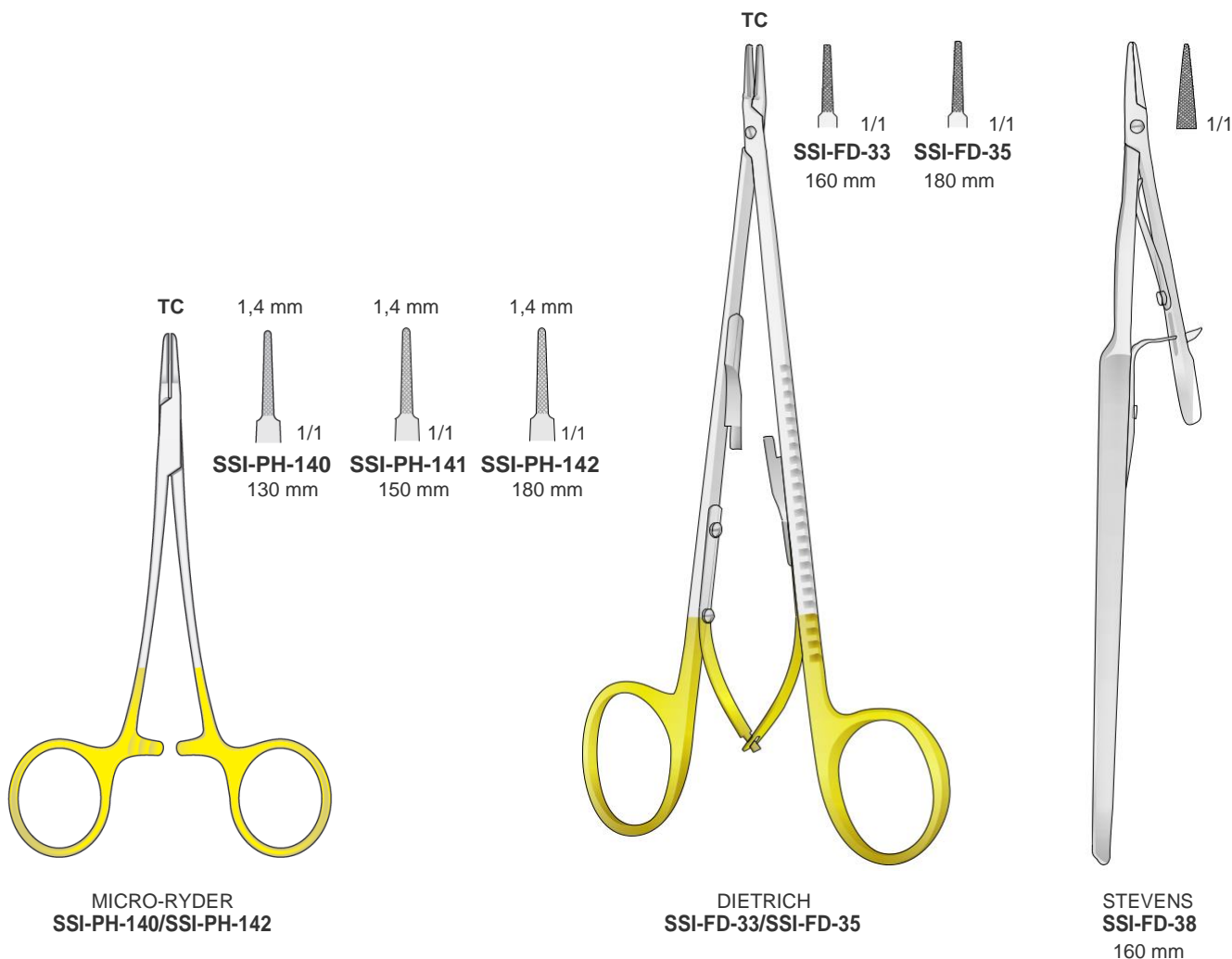
SSI-FD-587T/SSI-FD-588T
 180 mm

Email: sheffieldsurgicalinstruments@gmail.com
 Web: www.sheffieldsurgicalinst.com



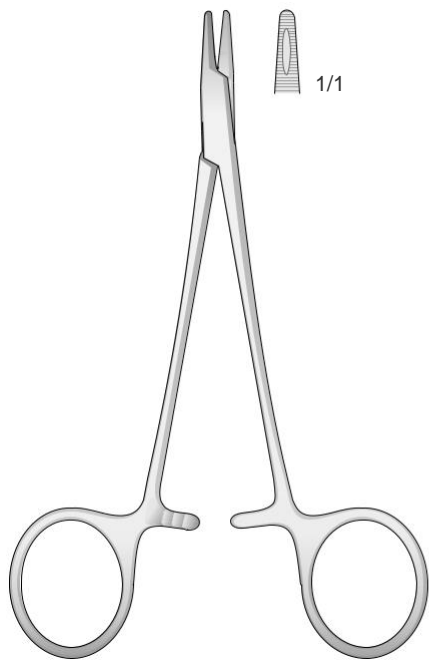
Nadelhalter
Needle Holders
Port'aghi
Portaagujas
Porte aiguilles

Tungsten-Carbide Inserts
Mit Hartmetalleinsätzen
Plaquettes en carbure de tungstène
Plaquetas de carburo de tungsteno
Inserti in carburo di tungsteno

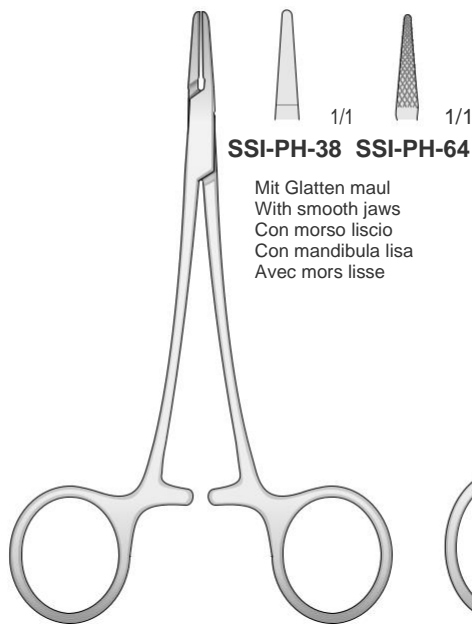


Email: sheffieldsurgicalinstruments@gmail.com
Web: www.sheffieldsurgicalinst.com

Nadelhalter
Needle Holders
Port'aghi
Portaagujas
Porte aiguilles

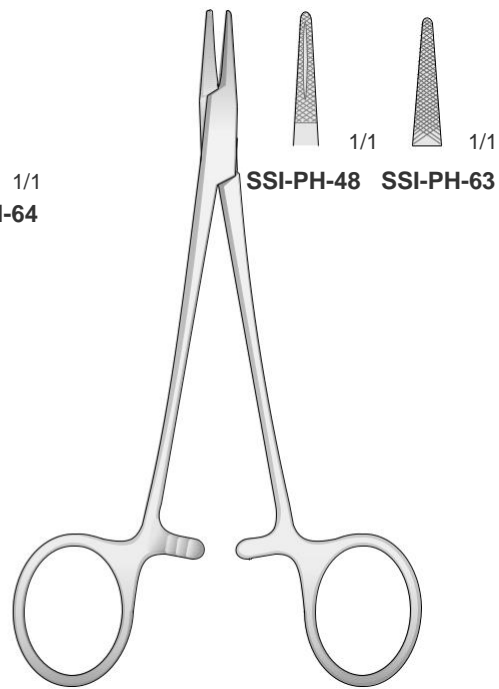


DERF
SSI-PH-39
125 mm

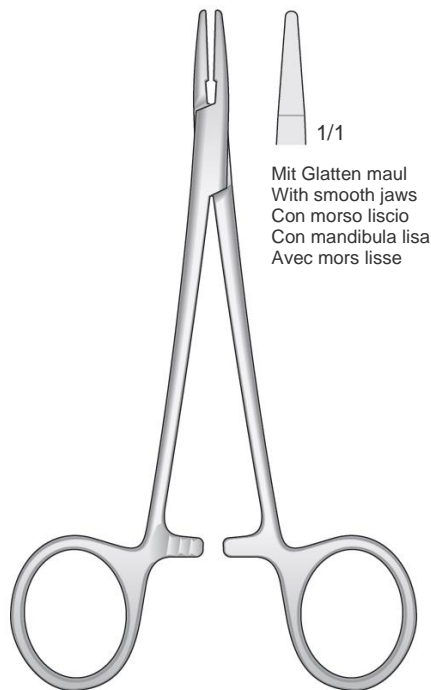


SSI-PH-38 SSI-PH-64
Mit Glatten maul
With smooth jaws
Con morso liscio
Con mandibula lisa
Avec mors lisse

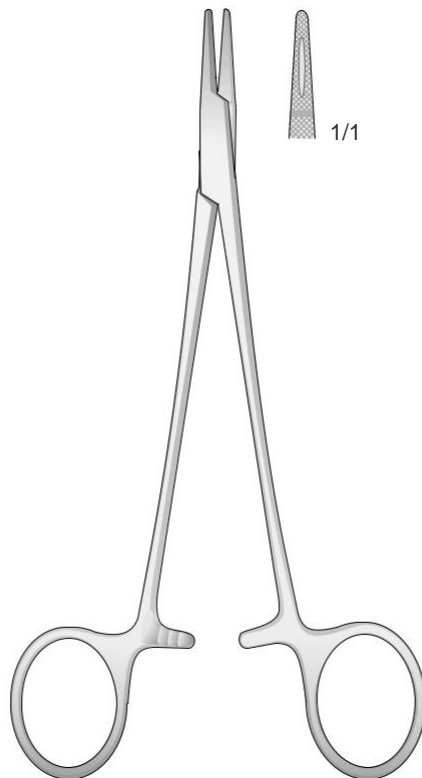
SSI-PH-38/SSI-PH-64
120 mm



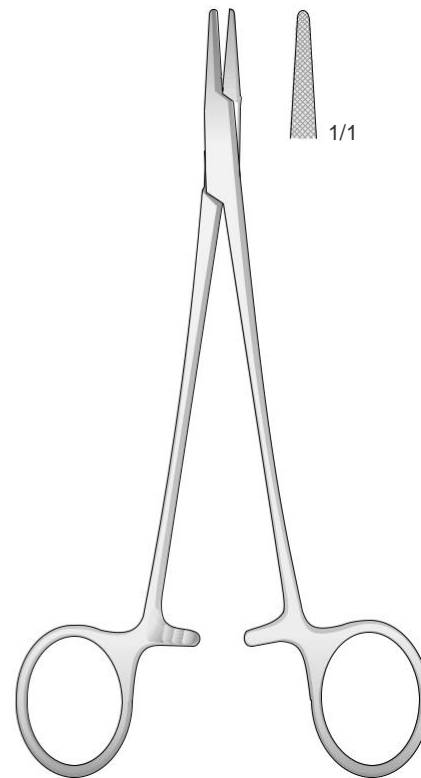
HALSEY
SSI-PH-48/SSI-PH-63
130 mm



HALSEY
SSI-PH-37
130 mm



CRILE-WOOD
SSI-PH-61
150 mm



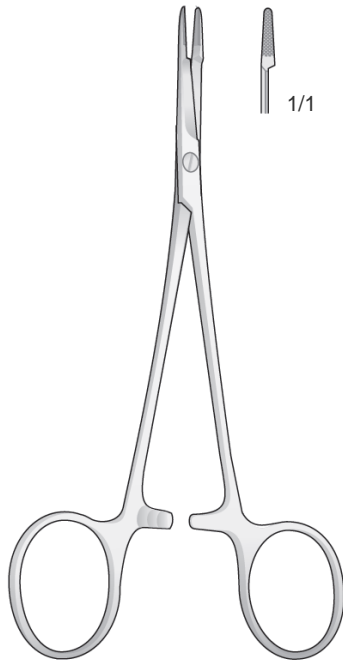
CRILE-MURRAY
SSI-PH-62
150 mm

Email: sheffieldsurgicalinstruments@gmail.com
Web: www.sheffieldsurgicalinst.com

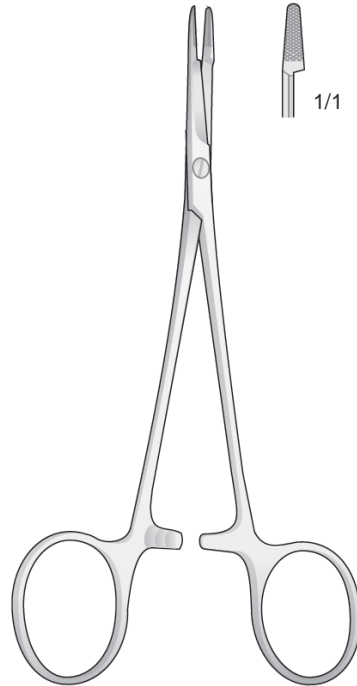


Nadelhalter mit Schere - Needle holders with scissors
Port'aghi con forbici - Portaagujas con tijeras
Porte aiguilles avec ciseaux

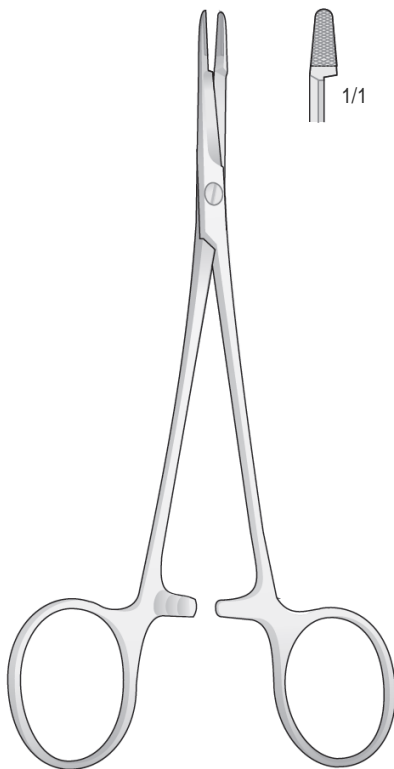
Nadelhalter
Needle Holders
Port'aghi
Portaagujas
Porte aiguilles



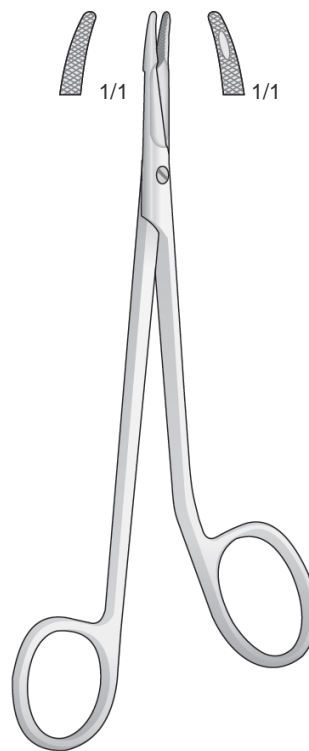
MINI-OLSEN-HEGAR
SSI-BM-61
120 mm



OLSEN-HEGAR
SSI-BM-62
140 mm



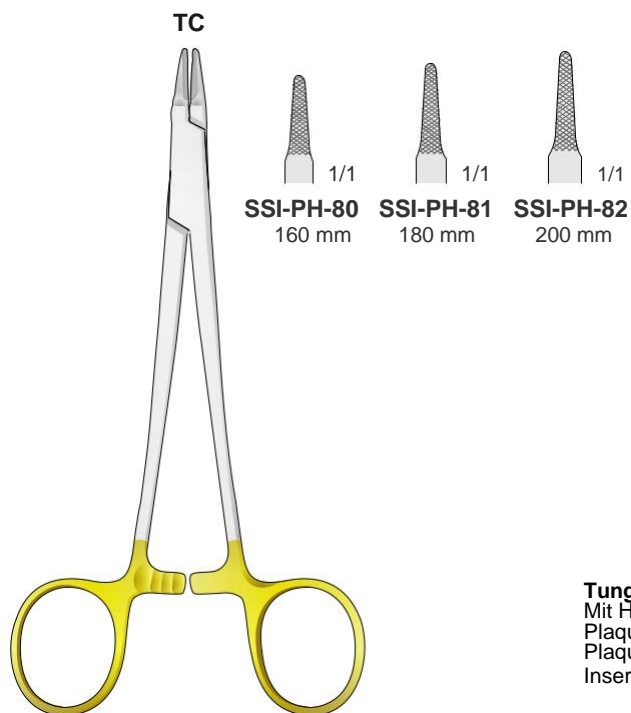
OLSEN-HEGAR
SSI-BM-63
170 mm



MINI-GILLIES
SSI-PO-59
145 mm

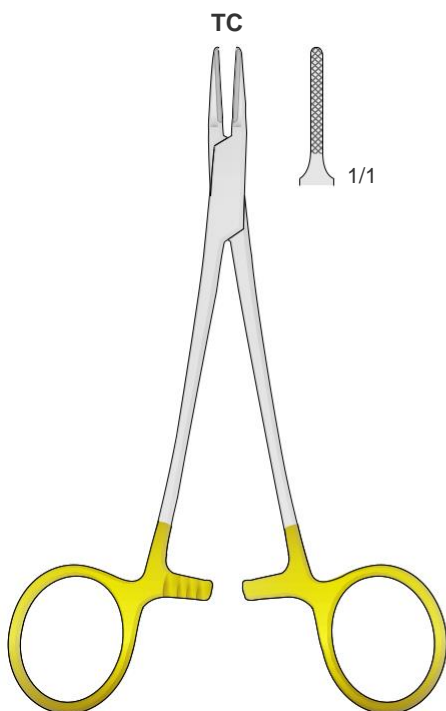
Email: sheffieldsurgicalinstruments@gmail.com
Web: www.sheffieldsurgicalinst.com

Nadelhalter
Needle Holders
Port'aghi
Portaagujas
Porte aiguilles

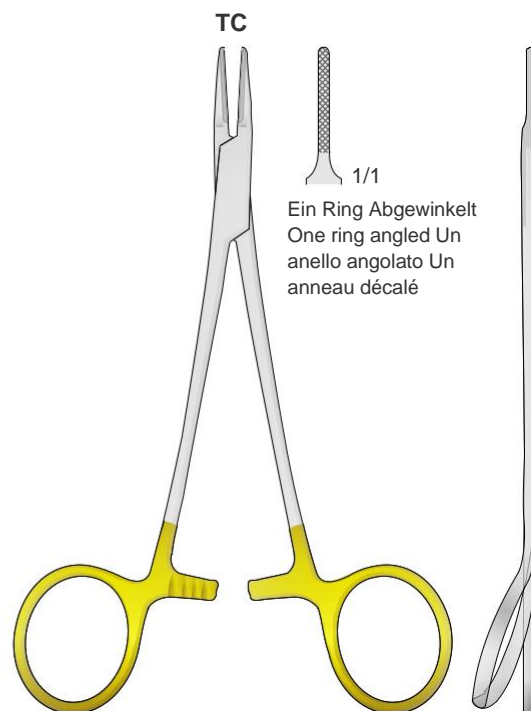


RYDER
SSPH-80/SSPH-82

Tungsten-Carbide Inserts
Mit Hartmetalleinsätzen
Plaquettes en carbure de tungstène
Plaquetas de carburo de tungsteno
Inserti in carburo di tungsteno



RYDER
SSPH-83
140 mm



SSPH-84
140 mm

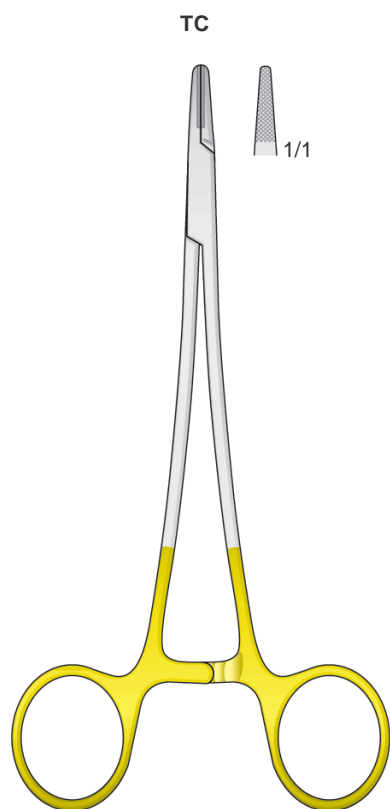
Ein Ring Abgewinkelt
One ring angled Un
anello angolato Un
anneau décalé

Email: sheffieldsurgicalinstruments@gmail.com
Web: www.sheffieldsurgicalinst.com

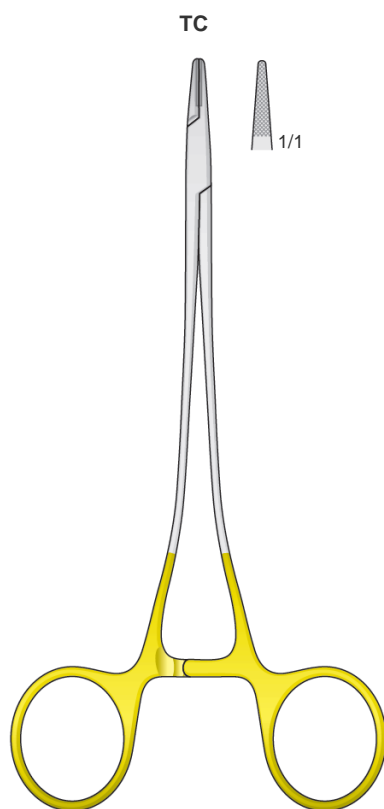


Nadelhalter
Needle Holders
Port'aghi
Portaagujas
Porte aiguilles

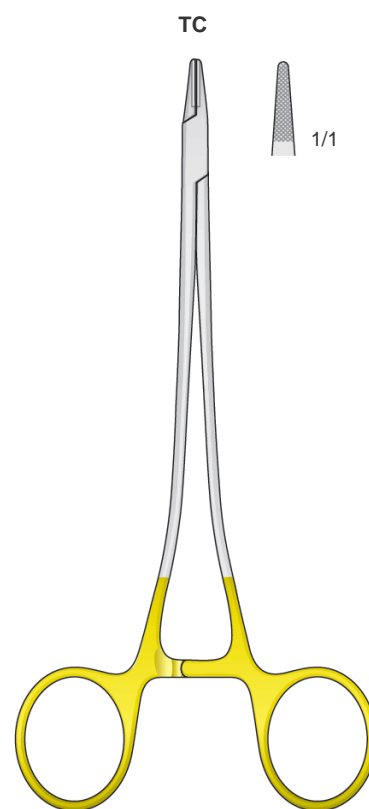
Tungsten-Carbide Inserts
Mit Hartmetalleinsätzen
Plaquettes en carbure de tungstène
Plaquetas de carburo de tungsteno
Inserti in carburo di tungsteno



SSI-PH-79
145 mm



FINE SWEDISH PATTERN
SSI-PH-85
150 mm

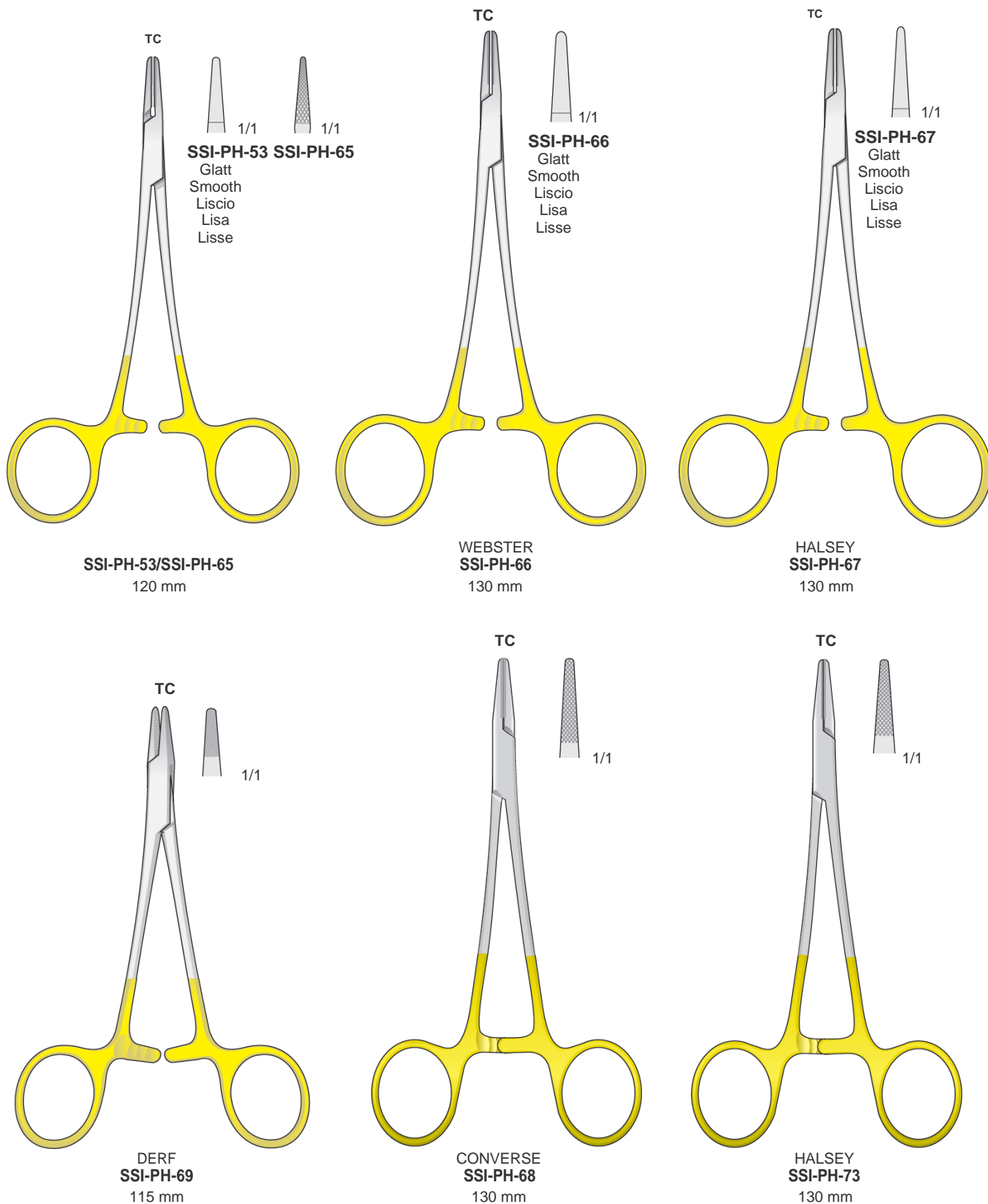


SWEDESH MOD.
SSI-PH-106
150 mm

Email: sheffieldsurgicalinstruments@gmail.com
Web: www.sheffieldsurgicalinst.com

Nadelhalter
Needle Holders
Port'aghi
Portaagujas
Porte aiguilles

Tungsten-Carbide Inserts
Mit Hartmetalleinsätzen
Plaquettes en carbure de tungstène
Plaquetas de carburo de tungsteno
Inserti in carburo di tungsteno

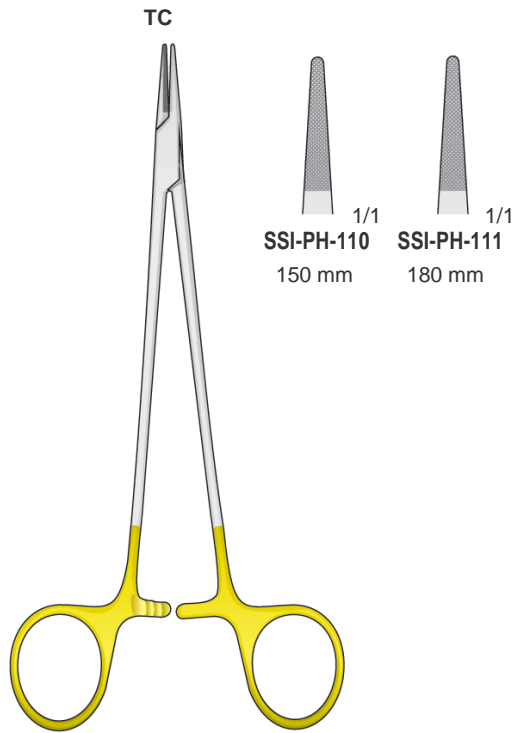


Email: sheffieldsurgicalinstruments@gmail.com
Web: www.sheffieldsurgicalinst.com

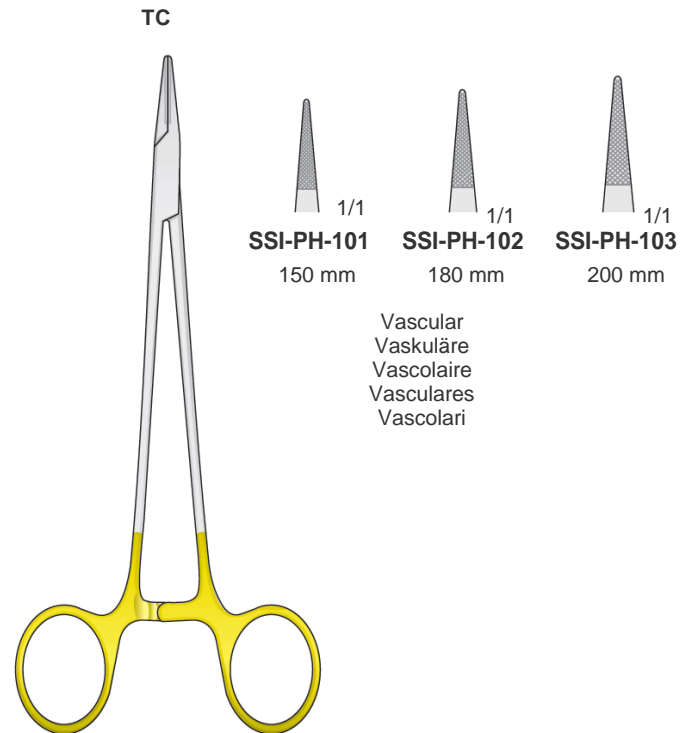


Tungsten-Carbide Inserts
Mit Hartmetalleinsätzen
Plaquettes en carbure de tungstène
Plaquetas de carburo de tungsteno
Inserti in carburo di tungsteno

Nadelhalter
Needle Holders
Port'aghi
Portaagujas
Porte aiguilles

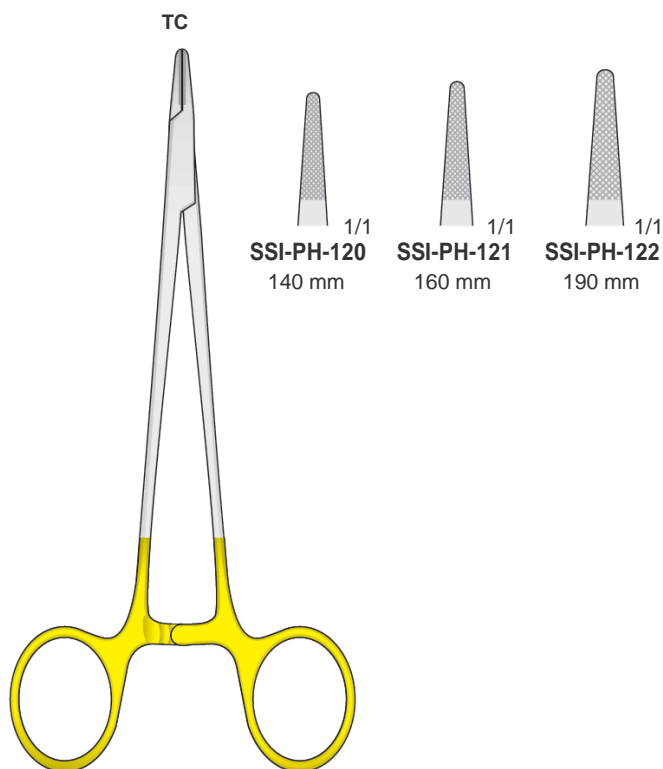


DE BAKEY
SSI-PH-110/SSI-PH-111

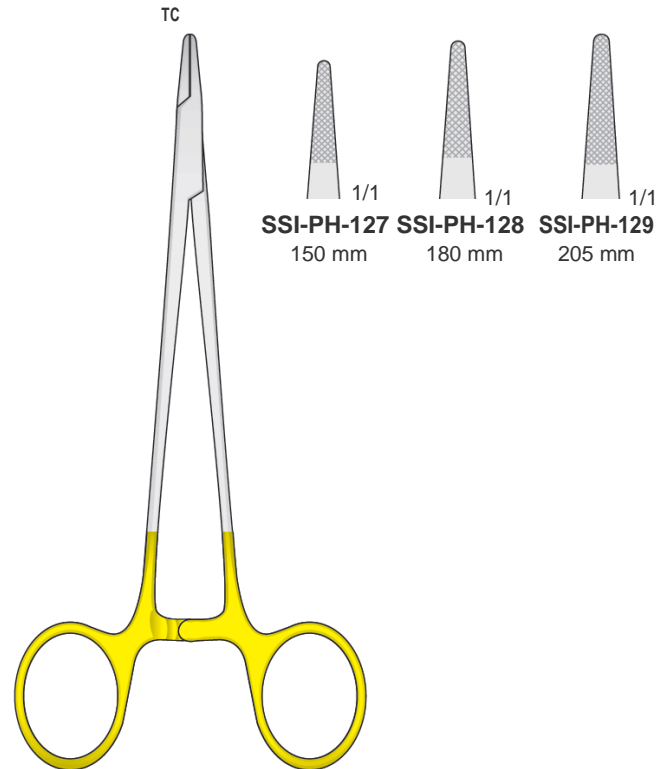


MICRO-VASCULAR
SSI-PH-101/SSI-PH-102/SSI-PH-103

Vascular
Vaskuläre
Vasculaire
Vasculares
Vascolari



MAYO-HEGAR
SSI-PH-120/SSI-PH-121/SSI-PH-122

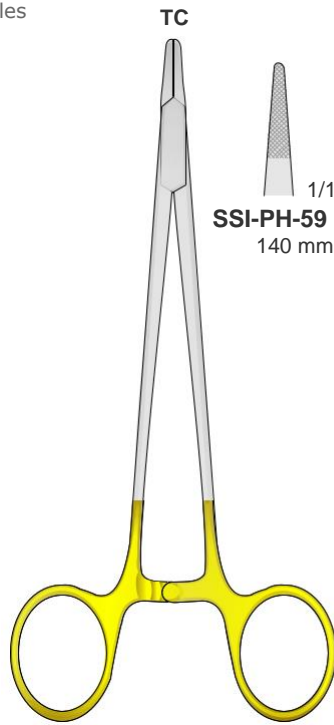


MAYO-HEGAR-FINO
SSI-PH-127/SSI-PH-128/SSI-PH-129

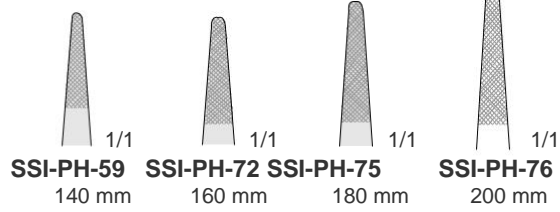
Email: sheffieldsurgicalinstruments@gmail.com
Web: www.sheffieldsurgicalinst.com

Nadelhalter
Needle Holders
Port'aghi
Portaagujas
Porte aiguilles

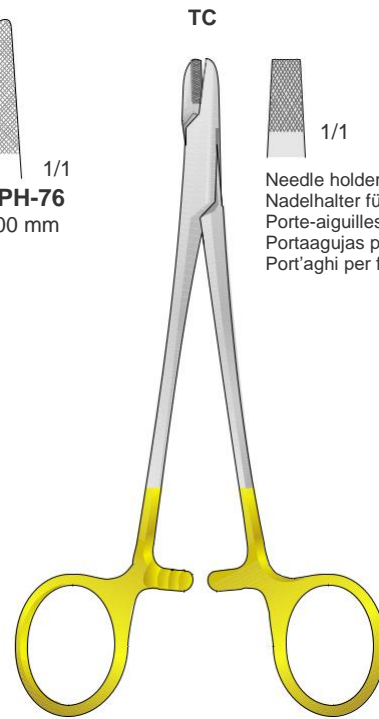
Tungsten-Carbide Inserts
Mit Hartmetalleinsätzen
Plaquettes en carbure de tungstène
Plaquetas de carburo de tungsteno
Inserti in carburo di tungsteno



TC



HEGAR
SSI-PH-59/SSI-PH-72/SSI-PH-75/SSI-PH-76

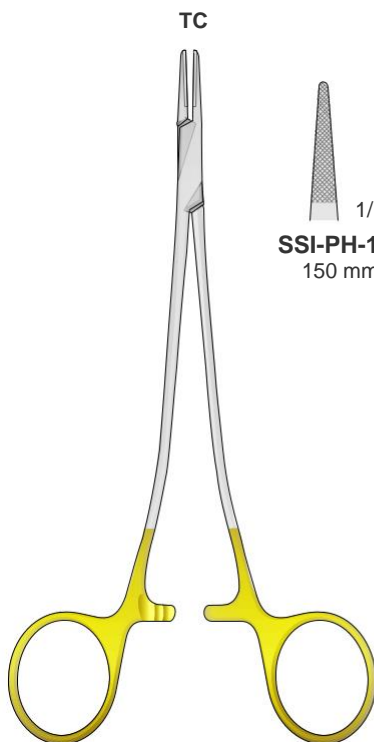


TC

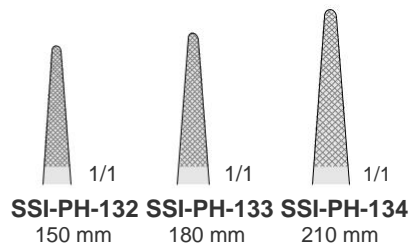


Needle holders for wire
Nadelhalter für drähte
Porte-aiguilles pour fil métallique
Portaagujas para hilo metálico
Port'aghi per fili metallici

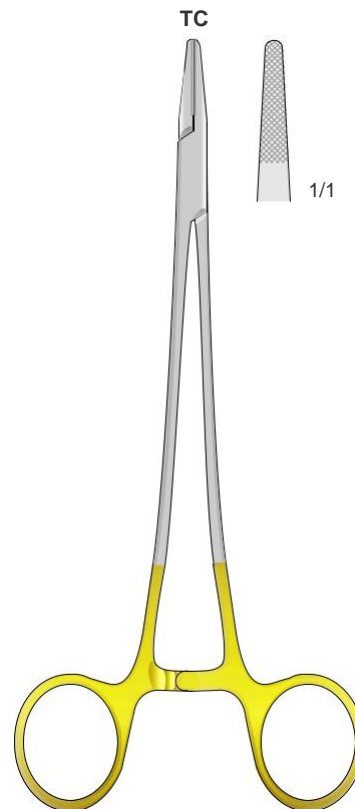
SSI-PH-58
150 mm



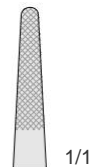
TC



SAROT
SSI-PH-132/SSI-PH-133/SSI-PH-134



TC



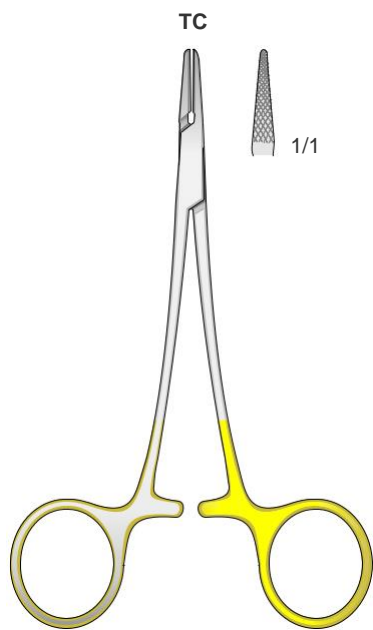
CRILE-WOOD
SSI-PH-77
180 mm

Email: sheffieldsurgicalinstruments@gmail.com
Web: www.sheffieldsurgicalinst.com

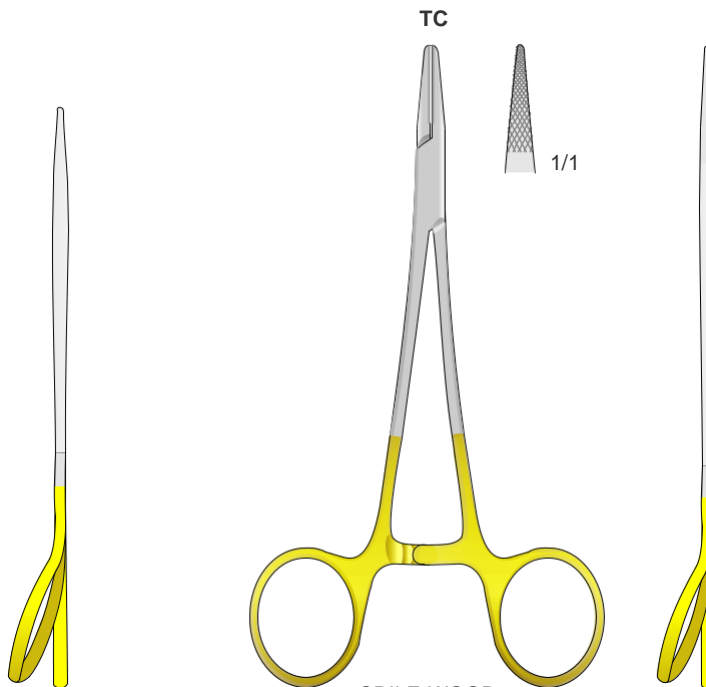


Tungsten-Carbide Inserts
Mit Hartmetalleinsätzen
Plaquettes en carbure de tungstène
Plaquetas de carburo de tungsteno
Inserti in carburo di tungsteno

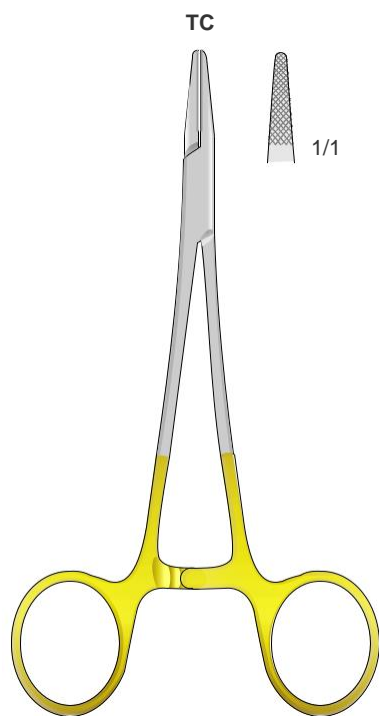
Nadelhalter
Needle Holders
Port'aghi
Portaagujas
Porte aiguilles



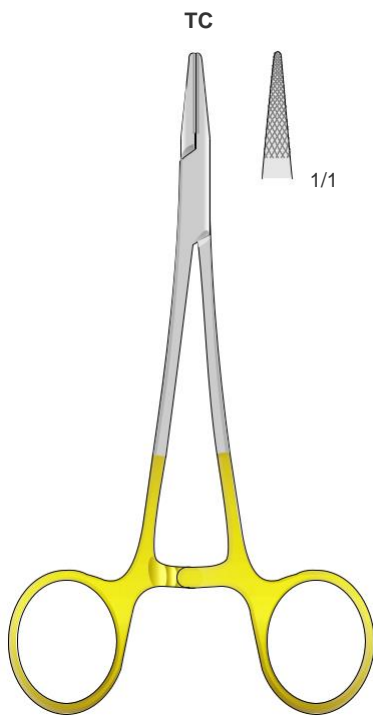
SSI-PH-99
120 mm



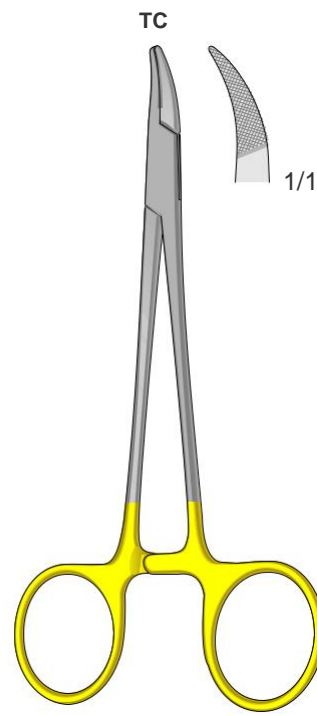
CRILE-WOOD
SSI-PH-100
150 mm



BABY-CRILE-WOOD
SSI-PH-54
150 mm



CRILE-WOOD
SSI-PH-71
150 mm

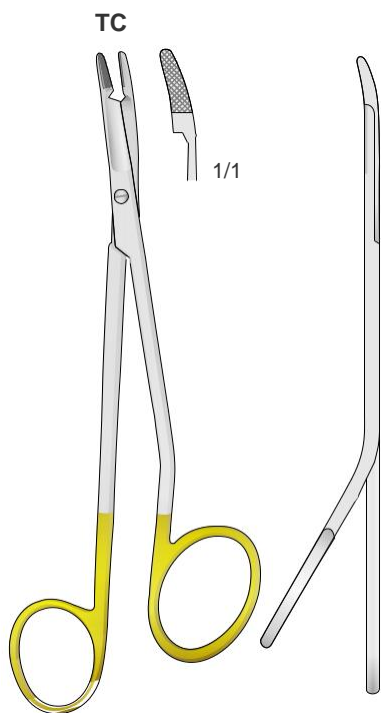


CRILE-WOOD
SSI-PH-90
150 mm

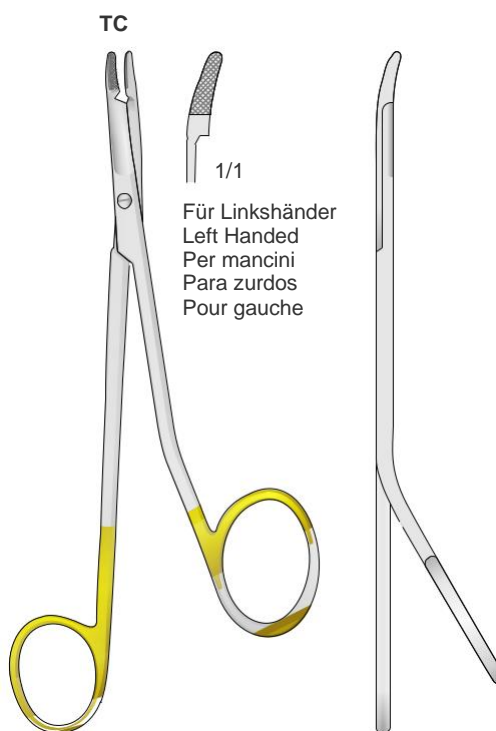
Email: sheffieldsurgicalinstruments@gmail.com
Web: www.sheffieldsurgicalinst.com

Nadelhalter
Needle Holders
Port'aghi
Portaagujas
Porte aiguilles

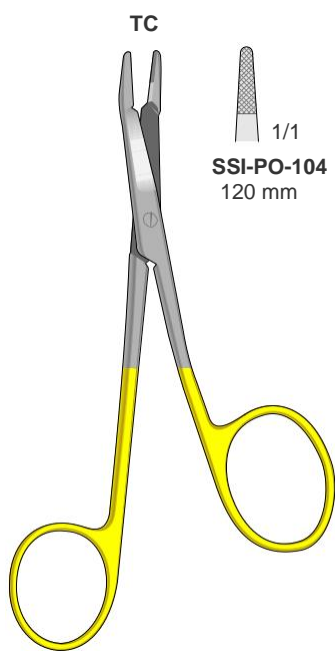
Tungsten-Carbide Inserts
Mit Hartmetalleinsätzen
Plaquettes en carbure de tungstène
Plaquetas de carburo de tungsteno
Inserti in carburo di tungsteno



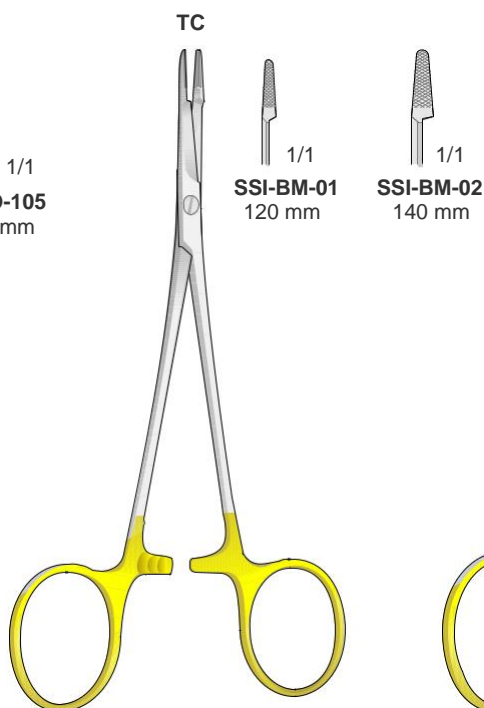
MINI-GILLIES
SSI-PO-99
145 mm



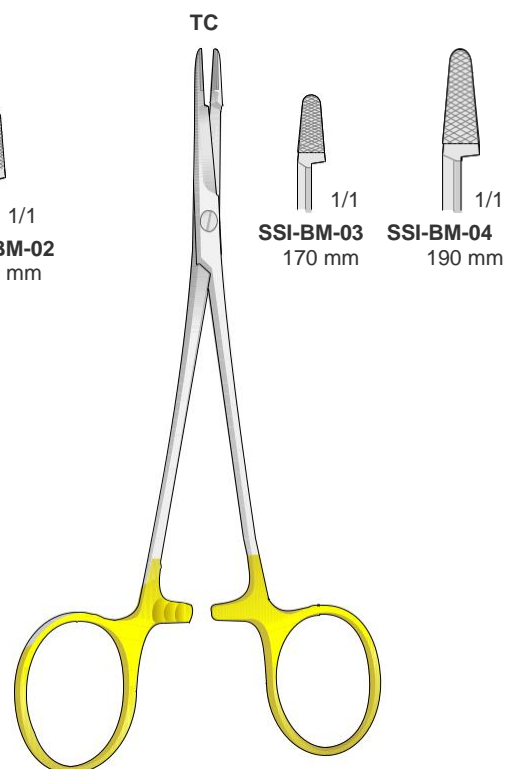
MINI-GILLIES
SSI-PO-99L
145 mm



FOSTER-GILLIES
SSI-PO-104/SSI-PO-105



OLSEN-HEGAR
SSI-BM-01/SSI-BM-02

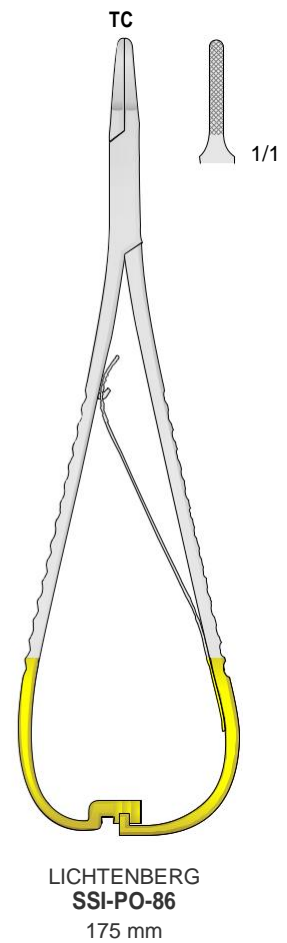
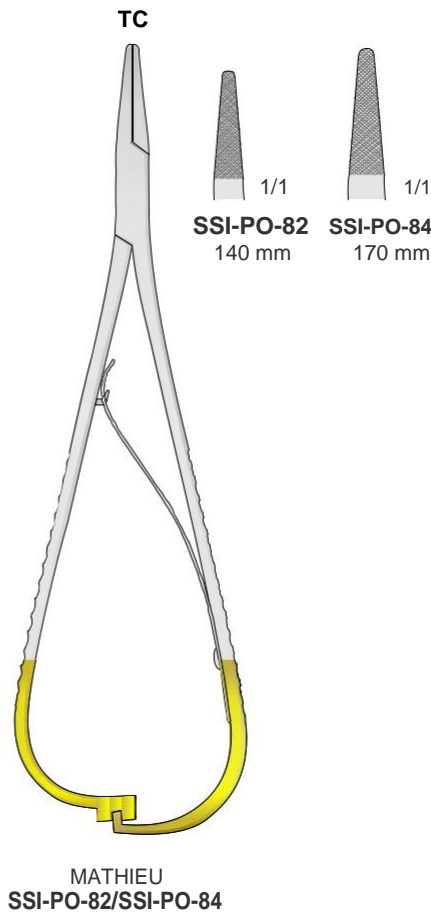
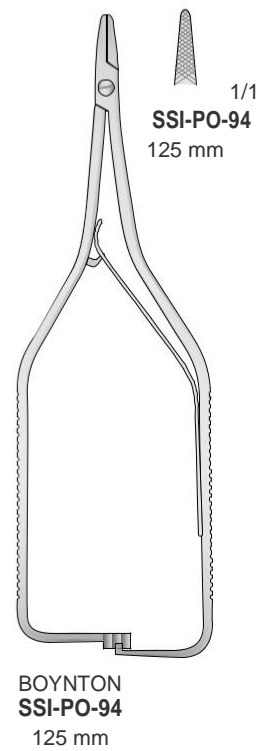
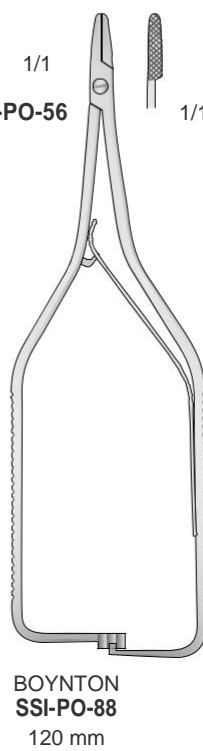
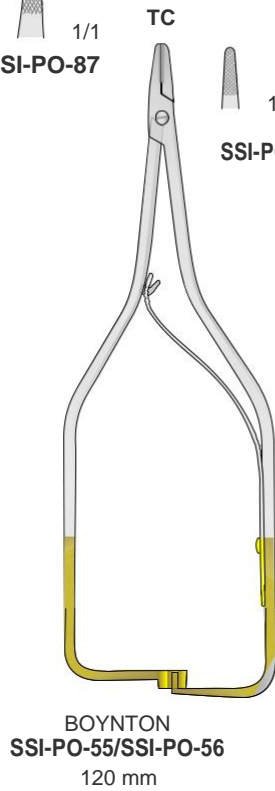
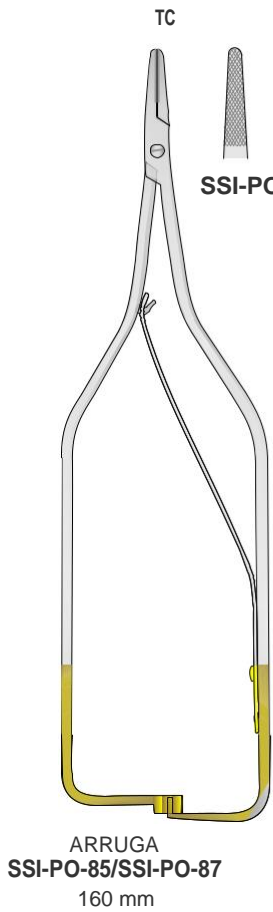


OLSEN-HEGAR
SSI-BM-03/SSI-BM-04

Email: sheffieldsurgicalinstruments@gmail.com
Web: www.sheffieldsurgicalinst.com

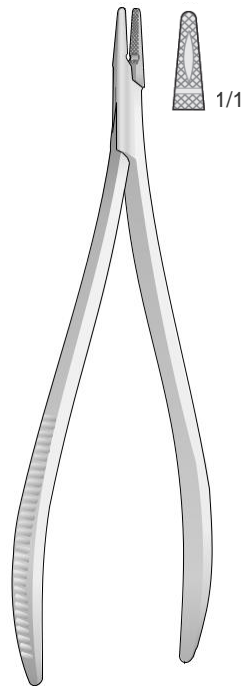


Nadelhalter
Needle Holders
Port'aghi
Portaagujas
Porte aiguilles

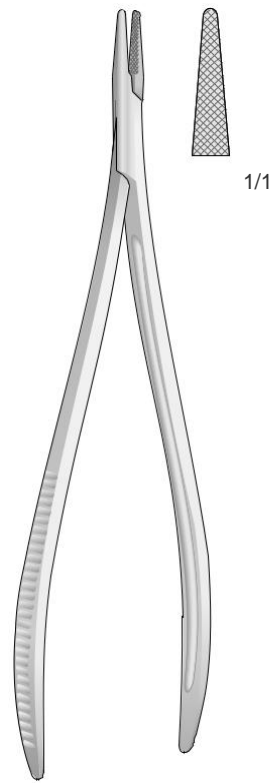


Email: sheffieldsurgicalinstruments@gmail.com
Web: www.sheffieldsurgicalinst.com

Nadelhalter
Needle Holders
Port'aghi
Portaagujas
Porte aiguilles

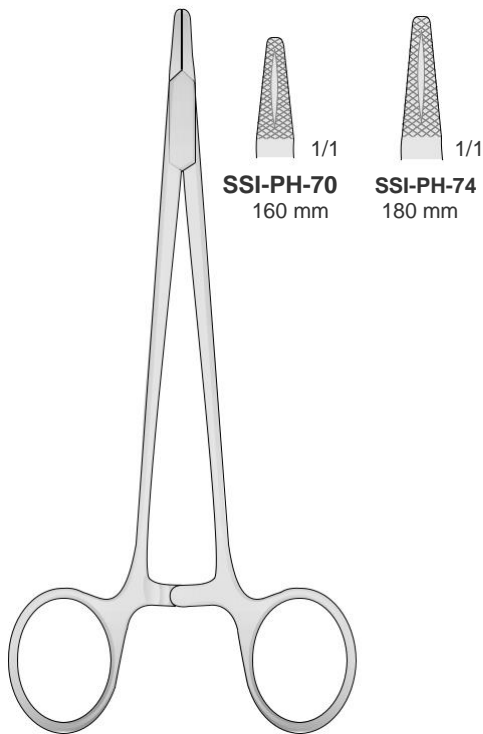


CRILE
SSI-PO-37
150 mm

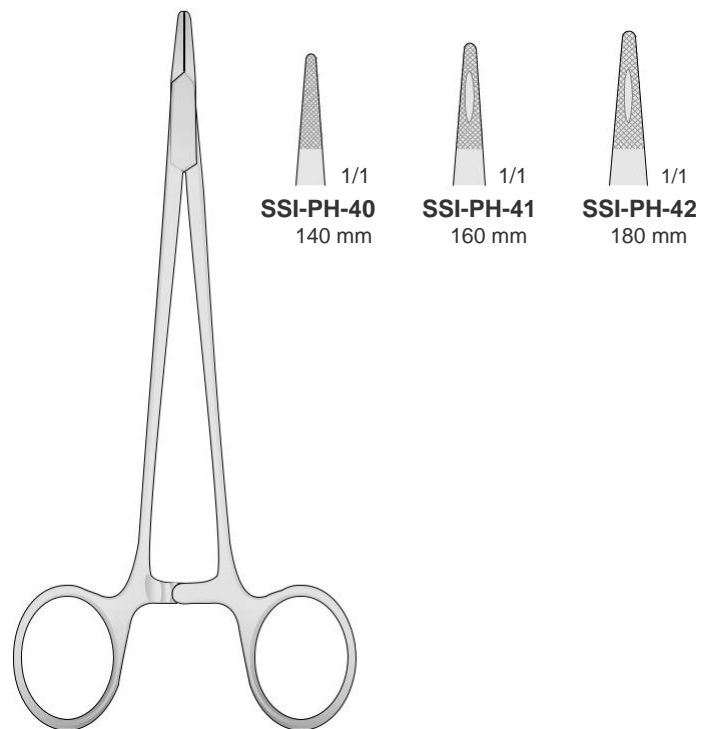


TÖNNIS
SSI-PO-38
190 mm

Schlankesmodell - Delicate pattern - Modello fine
Modelo delegado - Modèle fin



HEGAR
SSI-PH-70/SSI-PH-74

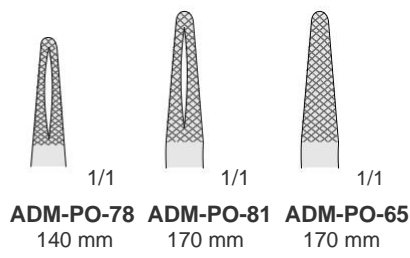
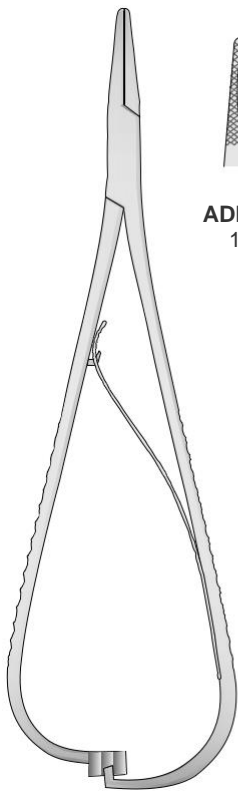


MAYO-HEGAR
SSI-PH-40/SSI-PH-42

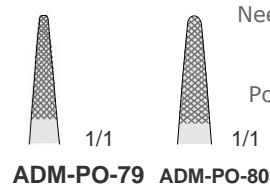
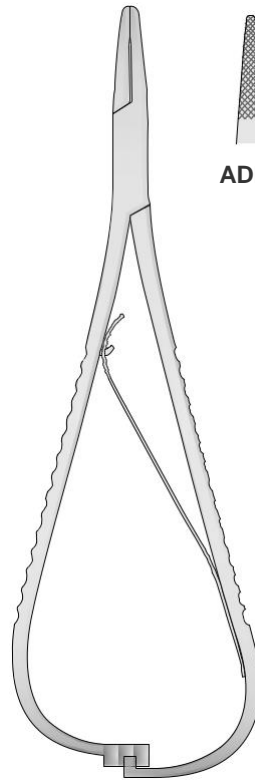
Email: sheffieldsurgicalinstruments@gmail.com
Web: www.sheffieldsurgicalinst.com



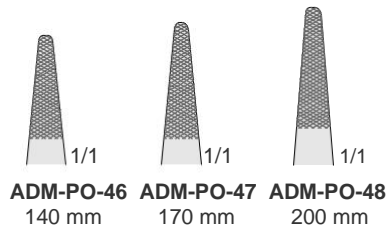
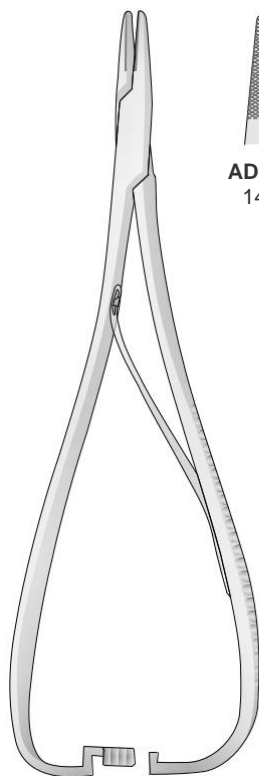
Nadelhalter
Needle Holders
Port'aghi
Portaagujas
Porte aiguilles



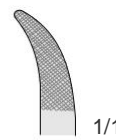
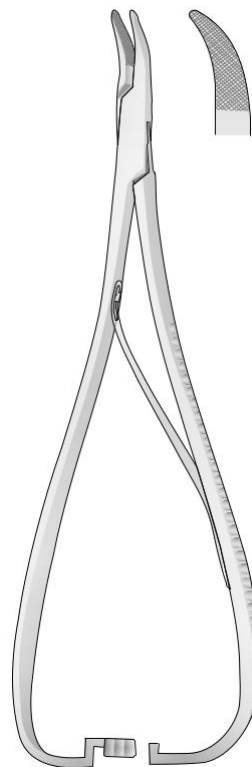
MATHIEU
ADM-PO-65/ADM-PO-81



MATHIEU
ADM-PO-79/ADM-PO-80
140 mm



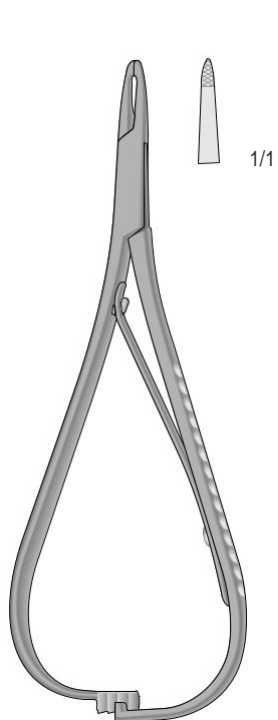
MATHIEU
ADM-PO-46/ADM-PO-48



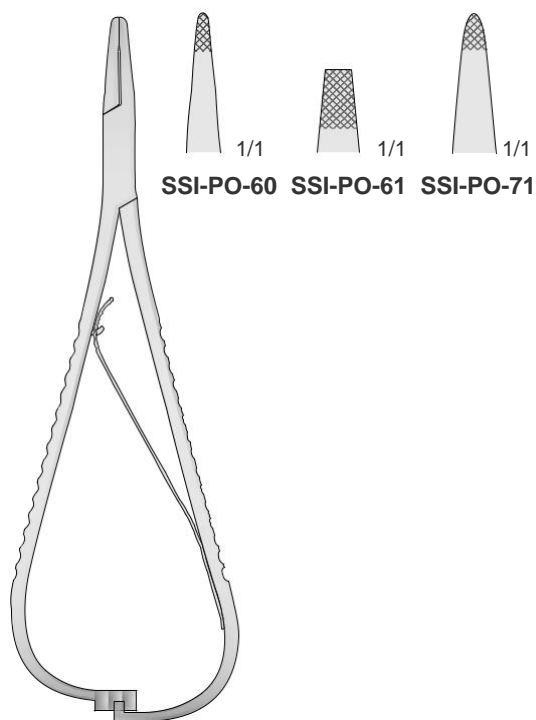
ADM-PO-40
140 mm

Email: sheffieldsurgicalinstruments@gmail.com
Web: www.sheffieldsurgicalinst.com

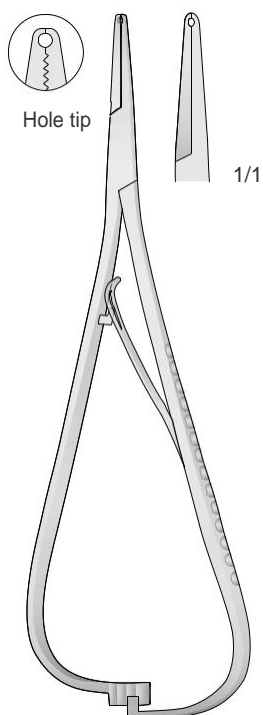
Nadelhalter
 Needle Holders
 Port'aghi
 Portaaguja
 Porte aiguilles



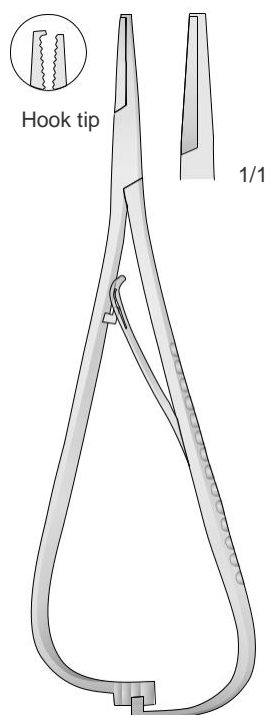
MATHIEU
SSI-PO-45
 125 mm



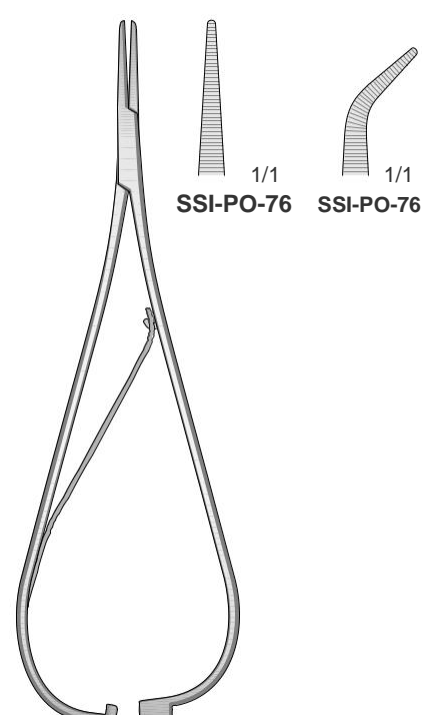
MATHIEU
SSI-PO-60/SSI-PO-71
 140 mm



SMAHA
SSI-PO-68
 140 mm



SMAHA
SSI-PO-69
 140 mm



SMAHA
SSI-PO-76/SSI-PO-77
 140 mm

Email: sheffieldsurgicalinstruments@gmail.com
 Web: www.sheffieldsurgicalinst.com

Sponge and Dressing Forceps

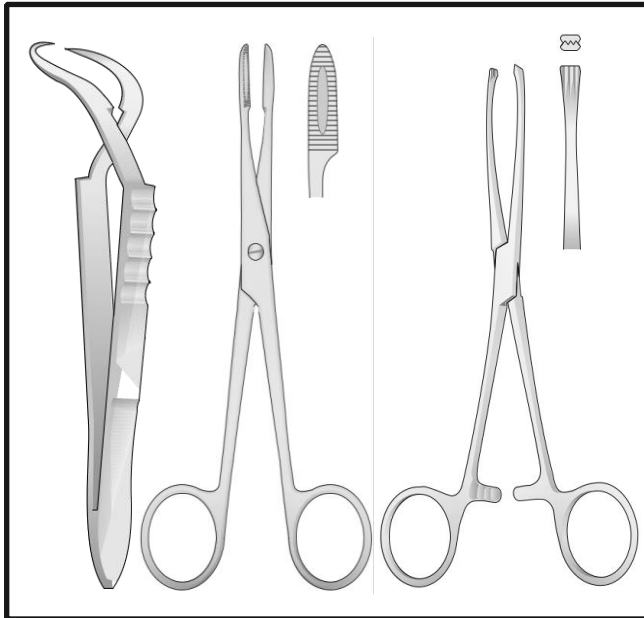
Schwamm und Tamponzangen
Pinces pour éponges et à pansement
Pinzas para esponja y tampones
Pinze per tamponi e spunge

Towel Clamps

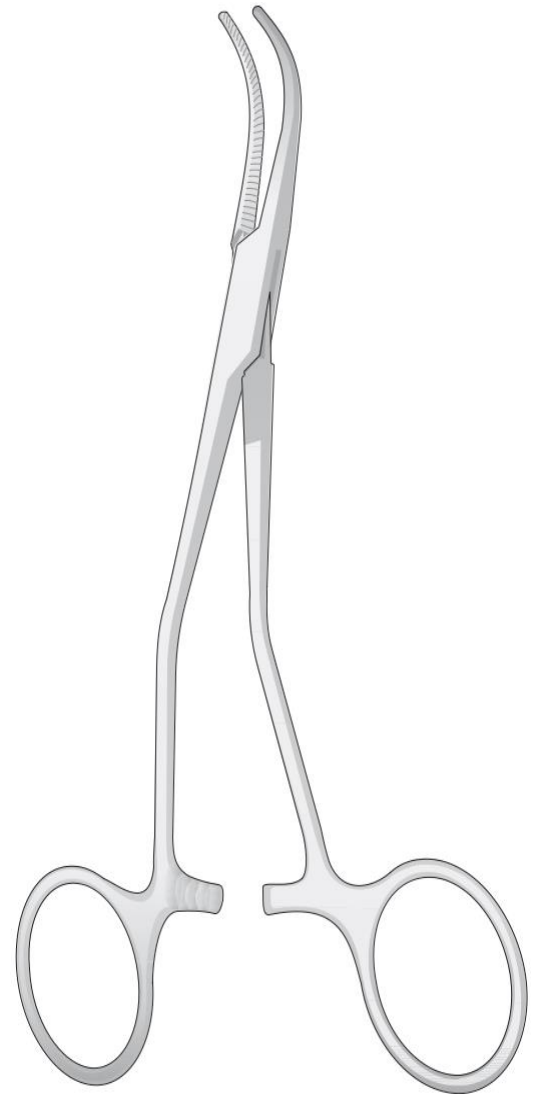
Tuchklemmen
Pinces fixe-compresse
Pinzas de campo
Fissateli

Hemostatic Forceps

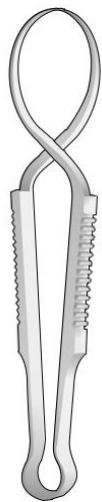
Arterienklemmen
Pinces hémostatiques
Pinzas hemostáticas
Pinzette emostatiche



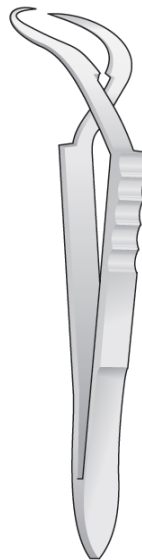
Sheffield Surgical is highly experienced Manufacturer & exporter of high quality Dental Instruments and also in the field of General Surgery, Bone Surgery an Orthopedic Instruments.



Tuchklemmen
Towel Clamps
Fissateli
Pinzas de campo
Pincas fixe-compresses



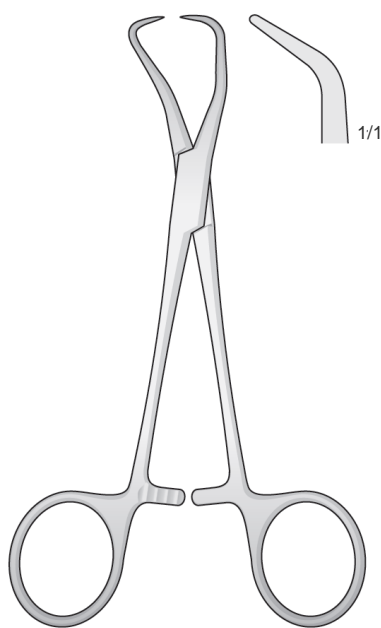
SCHAEDEL
SSI-BF-38
85 mm



JONES
SSI-BF-48
90 mm



FAURE
SSI-BF-40
85 mm



BACKHAUS
SSI-BF-42/SSI-BF-46



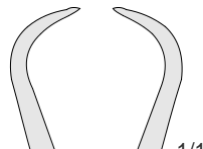
SSI-BF-42
90 mm



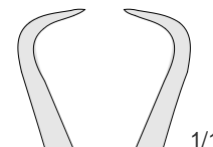
SSI-BF-41
100 mm



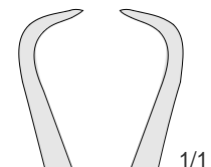
SSI-BF-44
110 mm



SSI-BF-46
130 mm



SSI-BF-43
135 mm



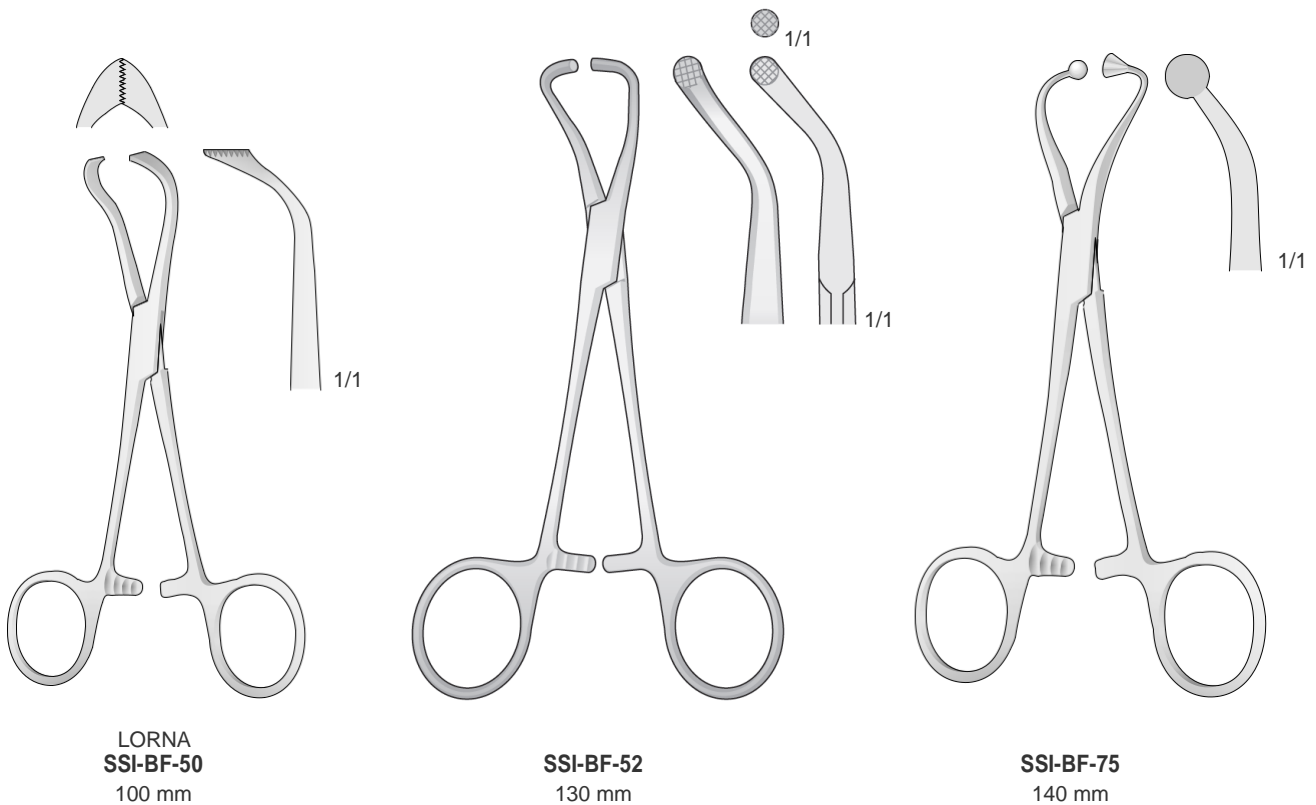
SSI-BF-45
140 mm

Email: sheffieldsurgicalinstruments@gmail.com
Web: www.sheffieldsurgicalinst.com



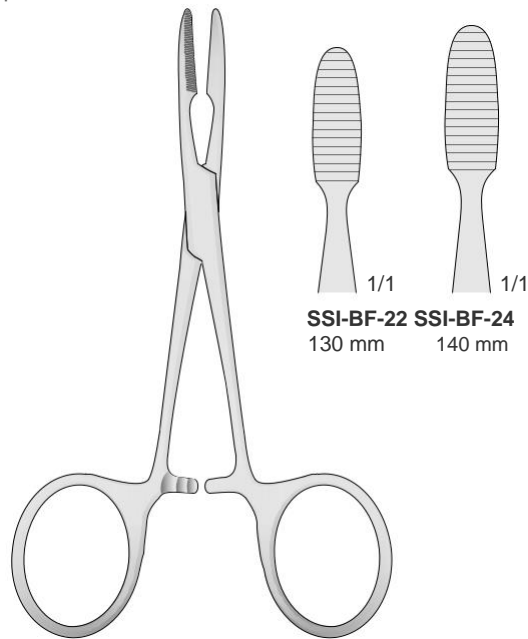
Tuchklemmen
Towel Clamps
Fissateli
Pinzas de campo
Pincas fixe-compresses

Für Papiertücher
For paper cloths
Per teli di carta
Para paños
Pour papier



Email: sheffieldsurgicalinstruments@gmail.com
Web: www.sheffieldsurgicalinst.com

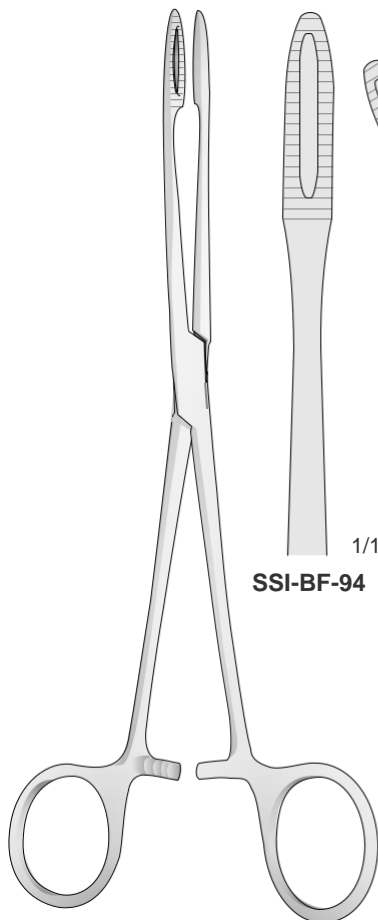
Schwamm und Tamponzangen
 Sponge and Dressing Forceps
 Pinze per tamponi e sponge
 Pinzas para esponja y tampones
 Pincas pour éponges et à pansement



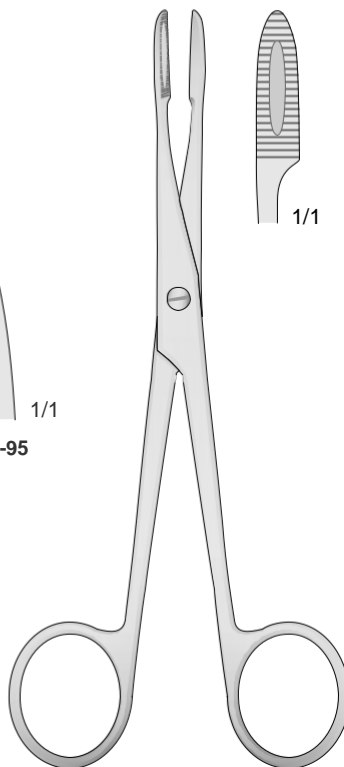
SSI-BF-22 130 mm
SSI-BF-24 140 mm

PEAN-MURPHY
SSI-BF-22/SSI-BF-24

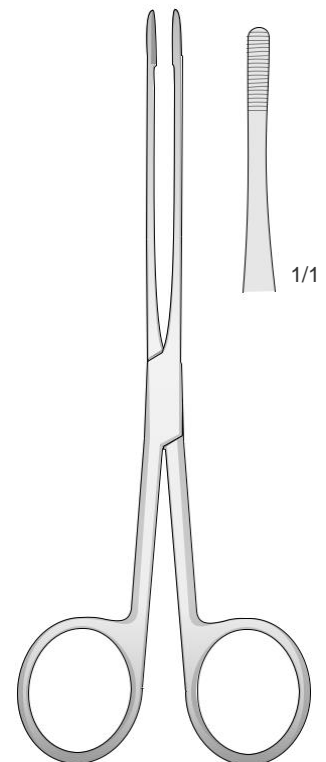
Sinus klemmen
 Sinus forceps
 Pinze Sinus
 Pinzas para seno
 Pincas à Sinus



GROSS
SSI-BF-94/SSI-BF-95
 200 mm



GROSS
SSI-BF-10 130 mm
SSI-BF-12 160 mm

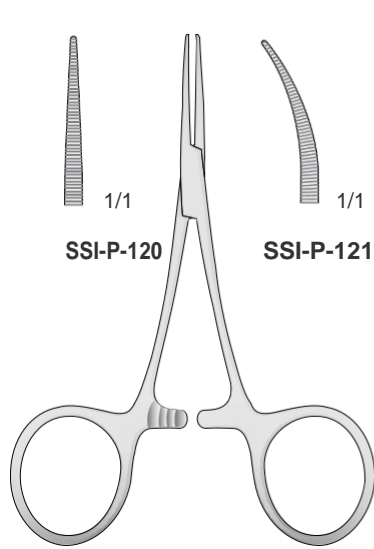


LISTER
SSI-BF-20
 150 mm

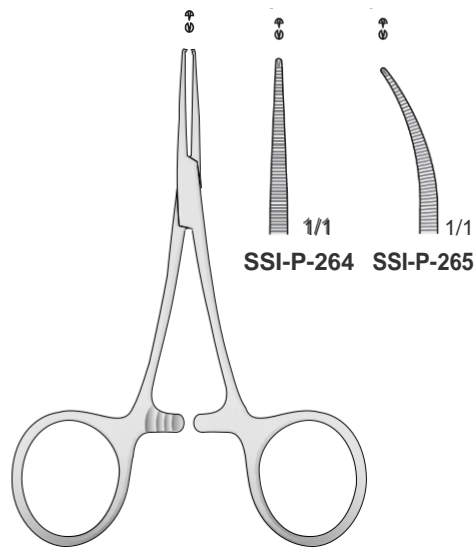
Email: sheffieldsurgicalinstruments@gmail.com
 Web: www.sheffieldsurgicalinst.com



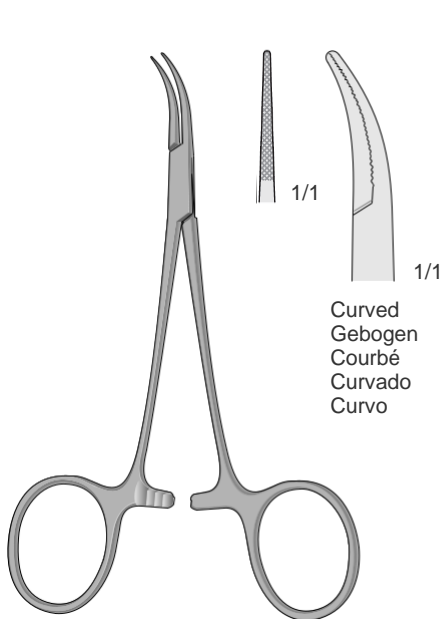
Arterienklemmen
Hemostatic Forceps
Pinze emostatiche
Pinzas hemostáticas
Pinces hémostatiques



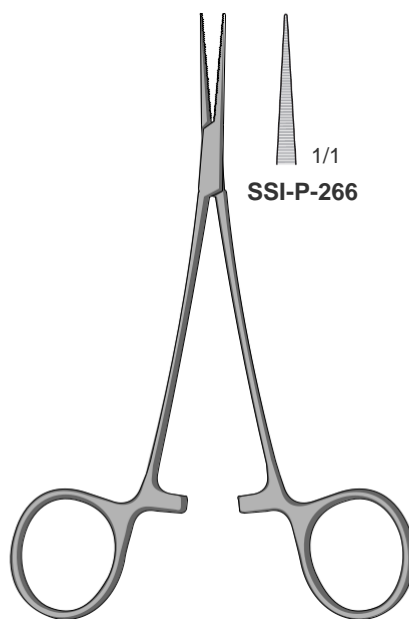
HARTMANN/BABY-MOSQUITO
SSI-P-120/SSI-P-121
95 mm



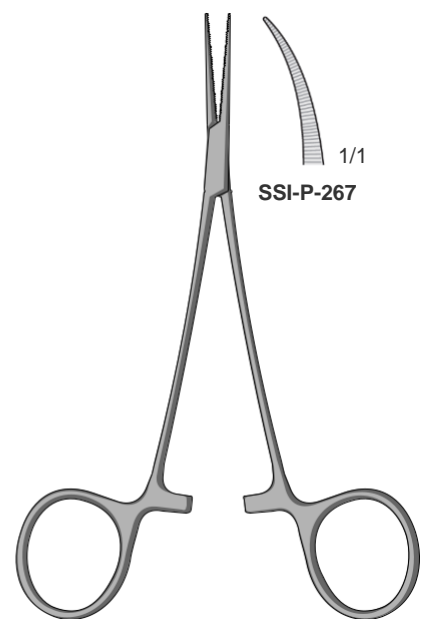
HARTMANN/BABY-MOSQUITO
SSI-P-264/SSI-P-265
95 mm



DANDY-MOSQUITO
SSI-P-332
120 mm



JACOBSON-MICRO
SSI-P-266
130 mm

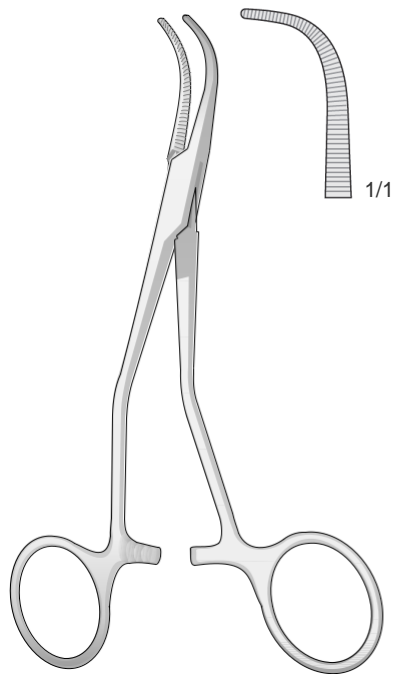


JACOBSON-MICRO
SSI-P-267
130 mm

Curved
Gebogen
Courbé
Curvado
Curvo

Email: sheffieldsurgicalinstruments@gmail.com
Web: www.sheffieldsurgicalinst.com

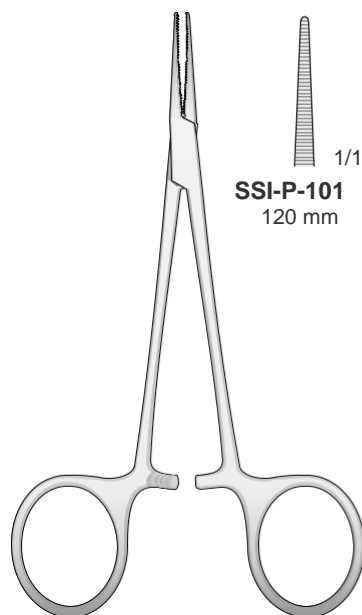
Arterienklemmen
 Hemostatic Forceps
 Pinze emostatiche
 Pinzas hemostáticas
 Pincas hémostatiques



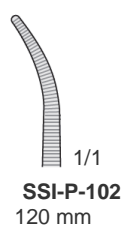
SSI-P-15
 130 mm



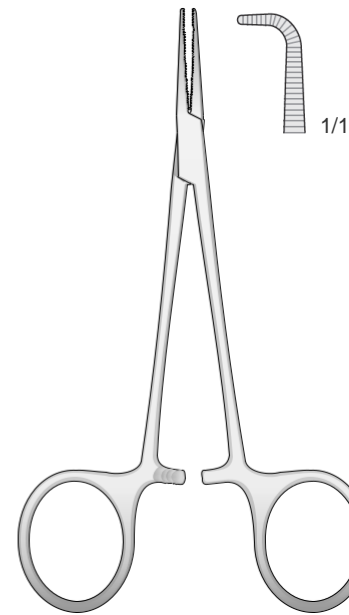
PEET
SSI-DR-40
 120 mm



SSI-P-101
 120 mm



SSI-P-102
 120 mm



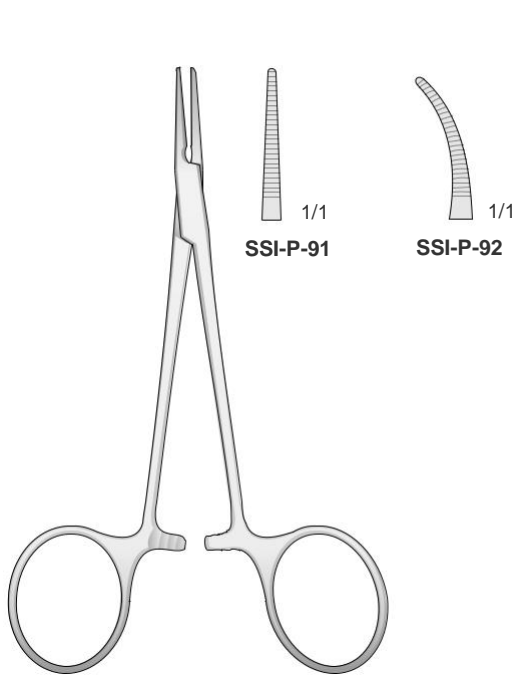
MICRO-HALSTED
SSI-P-135
 115 mm

MICRO-HALSTED
SSI-P-101/SSI-P-102

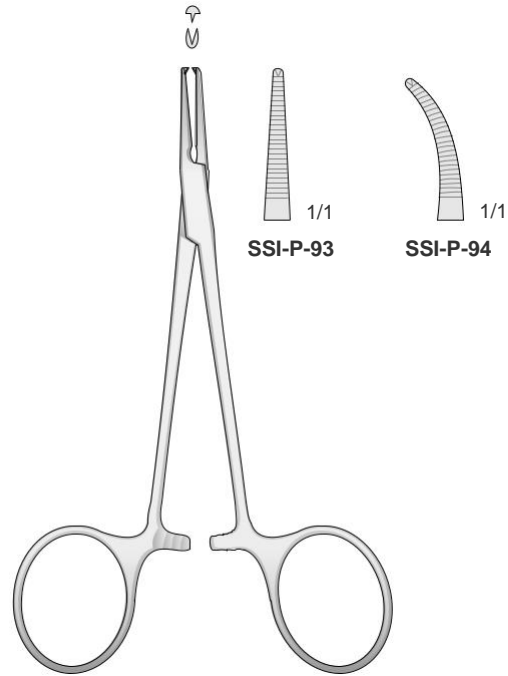
Email: sheffieldsurgicalinstruments@gmail.com
 Web: www.sheffieldsurgicalinst.com



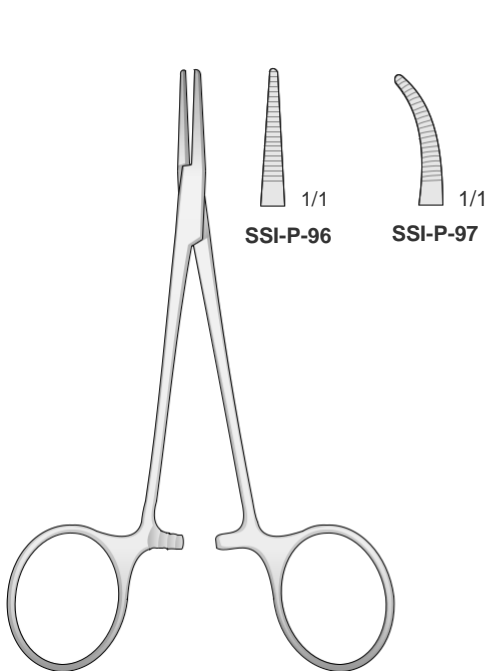
Arterienklemmen
Hemostatic Forceps
Pinze emostatiche
Pinzas hemostáticas
Pincas hémostatiques



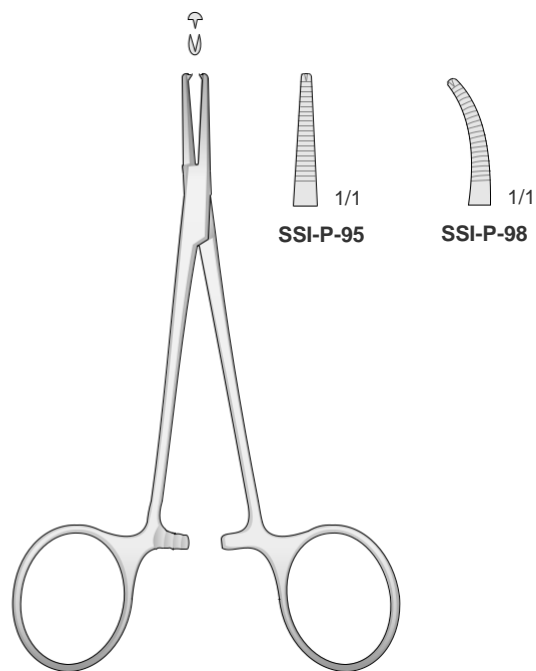
HALSTED
SSI-P-91/SSI-P-92
125 mm



HALSTED
SSI-P-93/SSI-P-94
125 mm



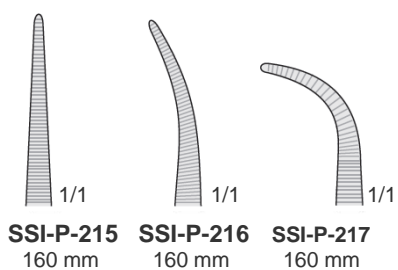
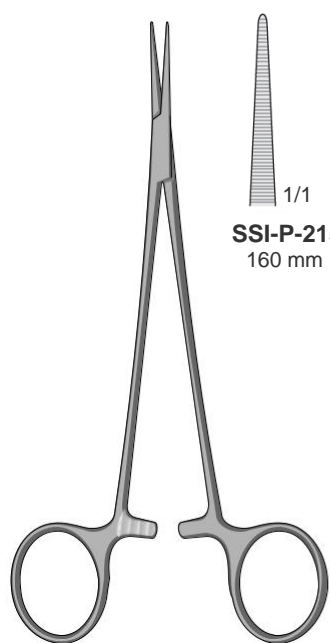
HALSTED-MOSQUITO
SSI-P-96/SSI-P-97
120 mm



HALSTED-MOSQUITO
SSI-P-95/SSI-P-98
120 mm

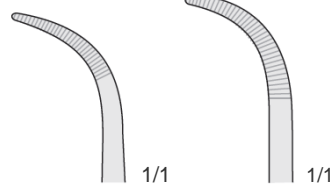
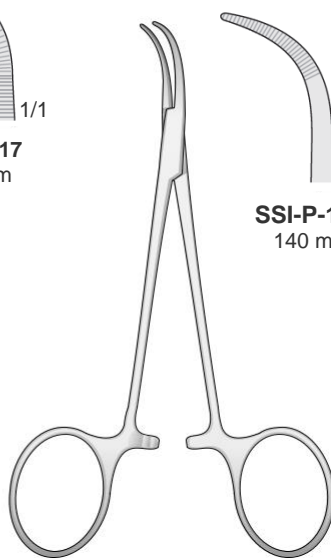
Email: sheffieldsurgicalinstruments@gmail.com
Web: www.sheffieldsurgicalinst.com

Arterienklemmen
 Hemostatic Forceps
 Pinze emostatiche
 Pinzas hemostáticas
 Pincés hémostatiques



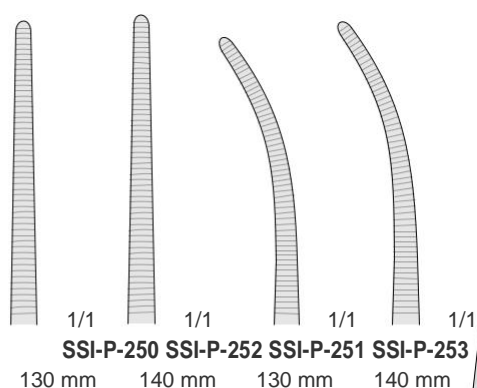
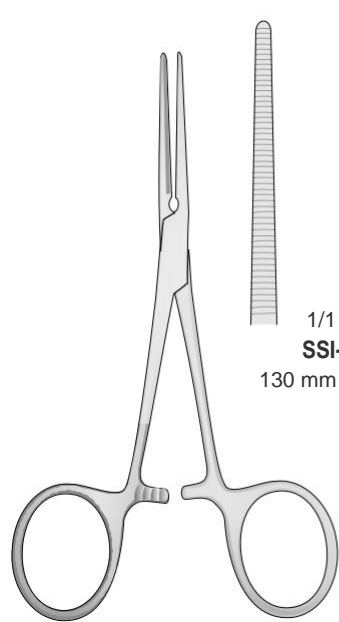
SSI-P-215 160 mm
SSI-P-216 160 mm
SSI-P-217 160 mm

SSI-P-215/SSI-P-217
 160 mm



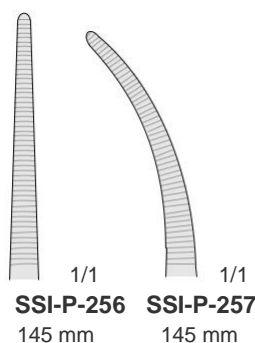
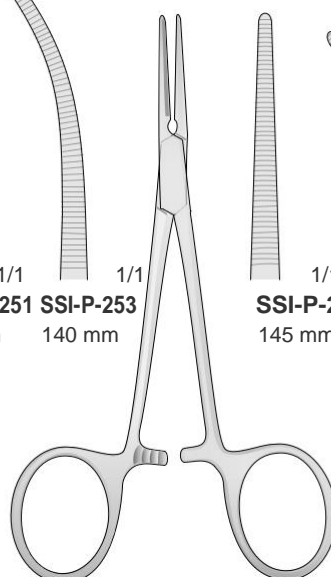
SSI-P-136 140 mm
SSI-P-137 180 mm

BABY-MIXTER
SSI-P-136/SSI-P-137



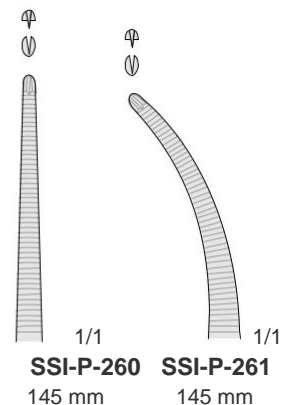
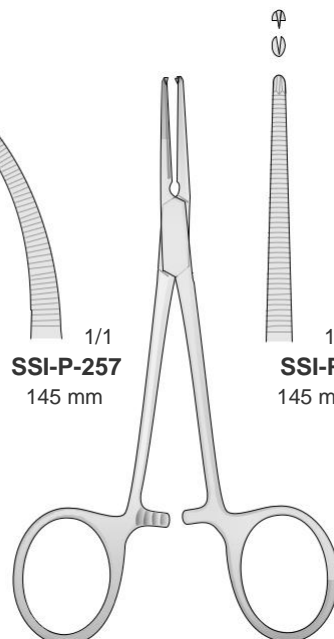
SSI-P-250 130 mm
SSI-P-252 140 mm
SSI-P-251 130 mm
SSI-P-253 140 mm

PEAN
SSI-P-250/SSI-P-253



SSI-P-256 145 mm
SSI-P-257 145 mm

PEAN
SSI-P-256/SSI-P-257



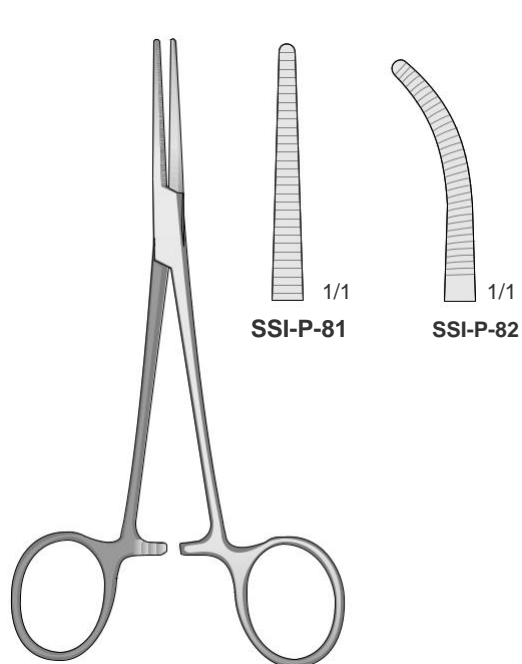
SSI-P-260 145 mm
SSI-P-261 145 mm

KOCHER
SSI-P-260/SSI-P-261

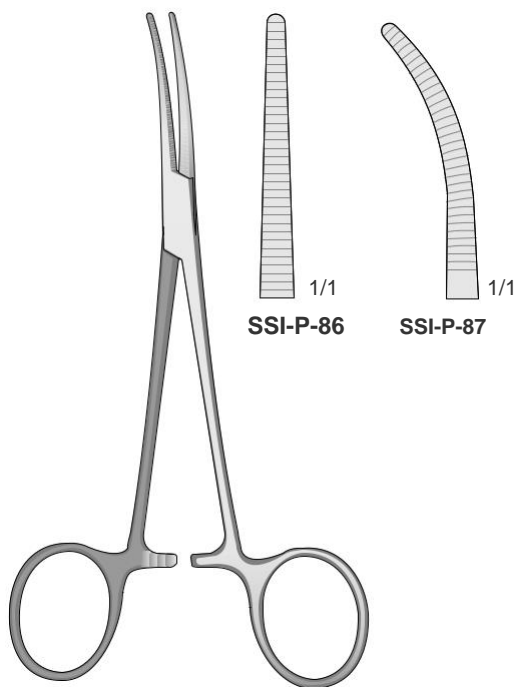
Email: sheffieldsurgicalinstruments@gmail.com
 Web: www.sheffieldsurgicalinst.com



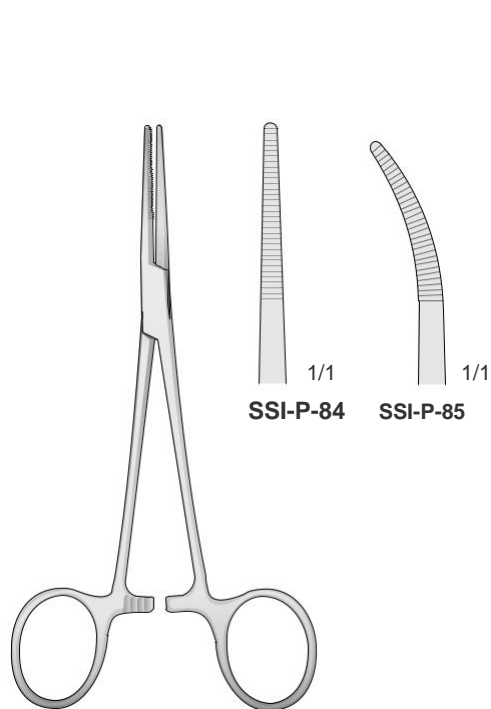
Arterienklemmen
Hemostatic Forceps
Pinze emostatiche
Pinzas hemostáticas
Pincas hémostatiques



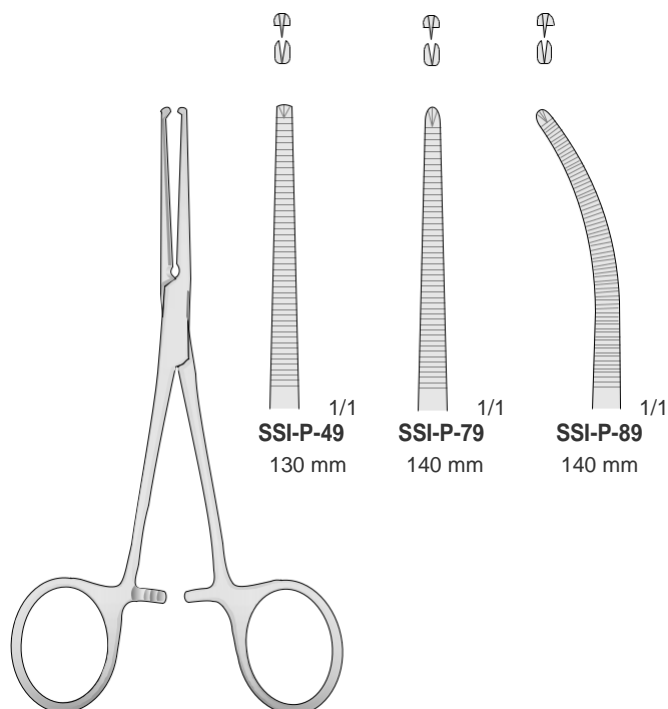
CRILE
SSI-P-81/SSI-P-82
140 mm



CRILE
SSI-P-86/SSI-P-87
160 mm



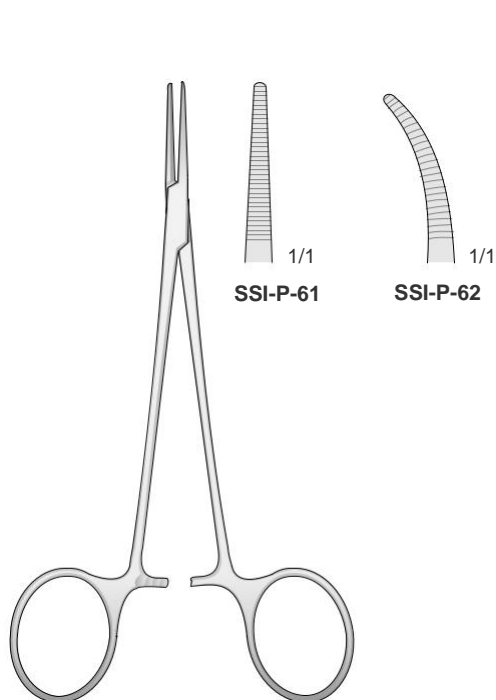
KELLY
SSI-P-84/SSI-P-85
140 mm



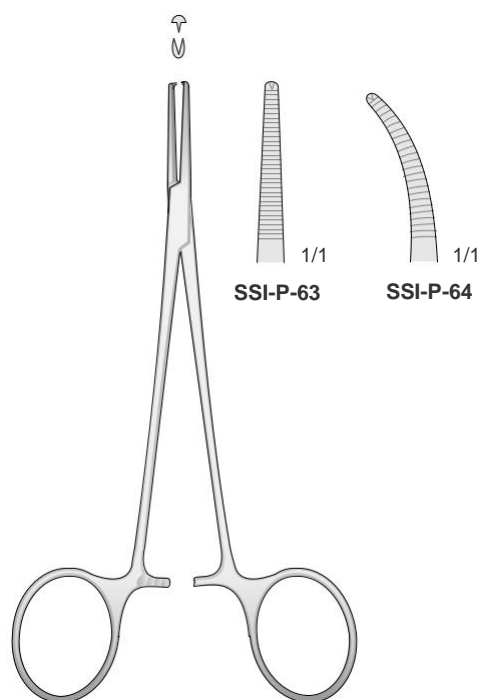
KOCHER
SSI-P-49/SSI-P-89

Email: sheffieldsurgicalinstruments@gmail.com
Web: www.sheffieldsurgicalinst.com

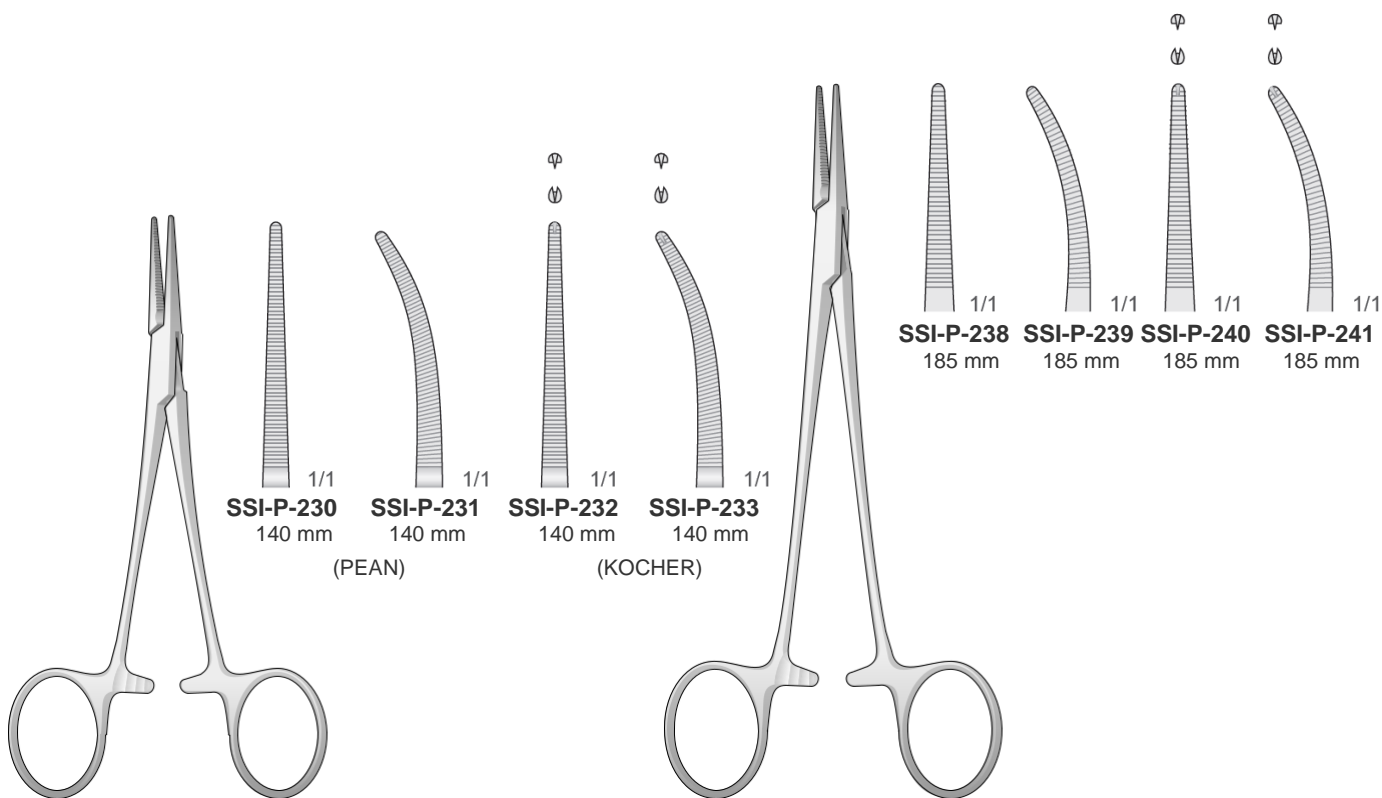
Arterienklemmen
 Hemostatic Forceps
 Pinze emostatiche
 Pinzas hemostáticas
 Pincas hémostatiques



LERICHE
 SSI-P-61/SSI-P-62
 150 mm



LERICHE
 SSI-P-63/SSI-P-64
 150 mm



BABY-CRILE
 SSI-P-230/SSI-P-233
 140 mm

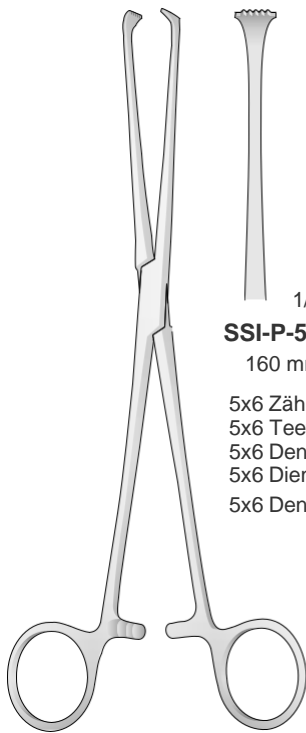
HALSTED
 SSI-P-238/SSI-P-241
 185 mm

Email: sheffieldsurgicalinstruments@gmail.com
 Web: www.sheffieldsurgicalinst.com



Gewebefasszangen
Tissue Grasping Forceps
Pinze per tessuti Pinzas
para tejidos Pinces pour
tissus

ATRAUMA



ALLIS
SSI-P-50/SSI-P-52

SSI-P-50
160 mm
5x6 Zähne
5x6 Teeth
5x6 Denti
5x6 Dientes
5x6 Dents

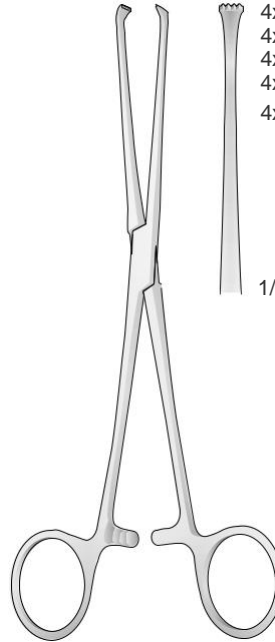
1/1

SSI-P-52
160 mm

1/1

SSI-P-115
200 mm
5x6 Zähne
5x6 Teeth
5x6 Denti
5x6 Dientes
5x6 Dents

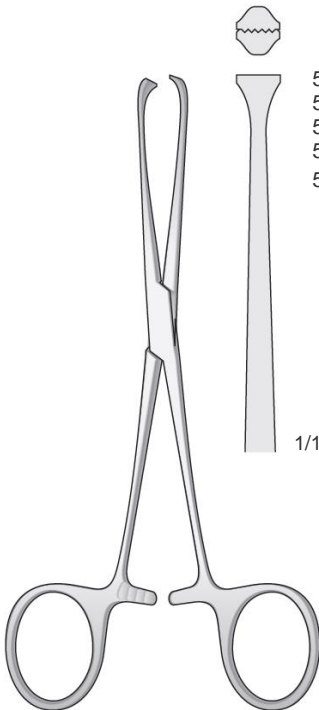
1/1



BABY-ALLIS
SSI-P-100
130 mm

4x5 Zähne
4x5 Teeth
4x5 Denti
4x5 Dientes
4x5 Dents

1/1

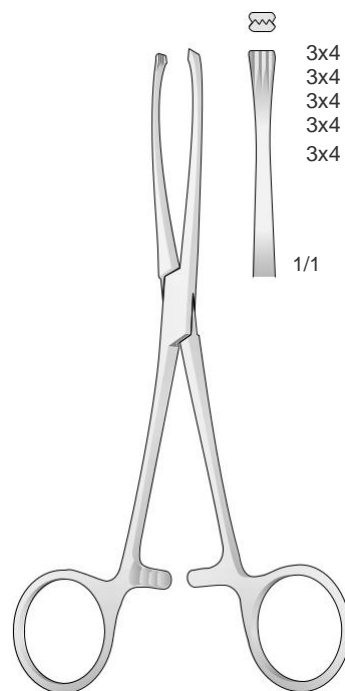


BOYS-ALLIS
SSI-P-129
150 mm



5x6 Zähne
5x6 Teeth
5x6 Denti
5x6 Dientes
5x6 Dents

1/1



JUDD-ALLIS
SSI-P-324
155 mm



3x4 Zähne
3x4 Teeth
3x4 Denti
3x4 Dientes
3x4 Dents

1/1

Email: sheffieldsurgicalinstruments@gmail.com
Web: www.sheffieldsurgicalinst.com

Tongue Depressor

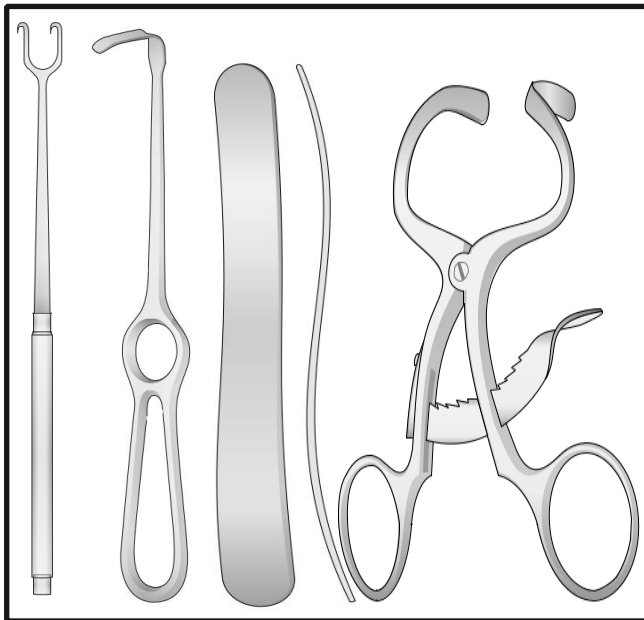
Zungendrucker
Abaisse-langue
Bajalengua
Abbassalingua

Mouth Gags | Mouth Prop

Mundsperrer
Ouvre-bouche
Abrebocas
Apribocca

Retractors

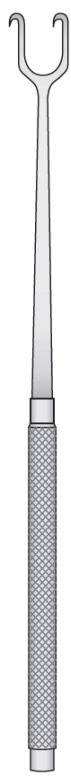
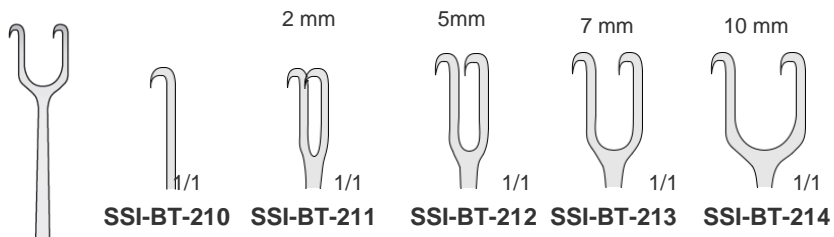
Retraktoren
Écarteurs
Separadores
Divaricatori



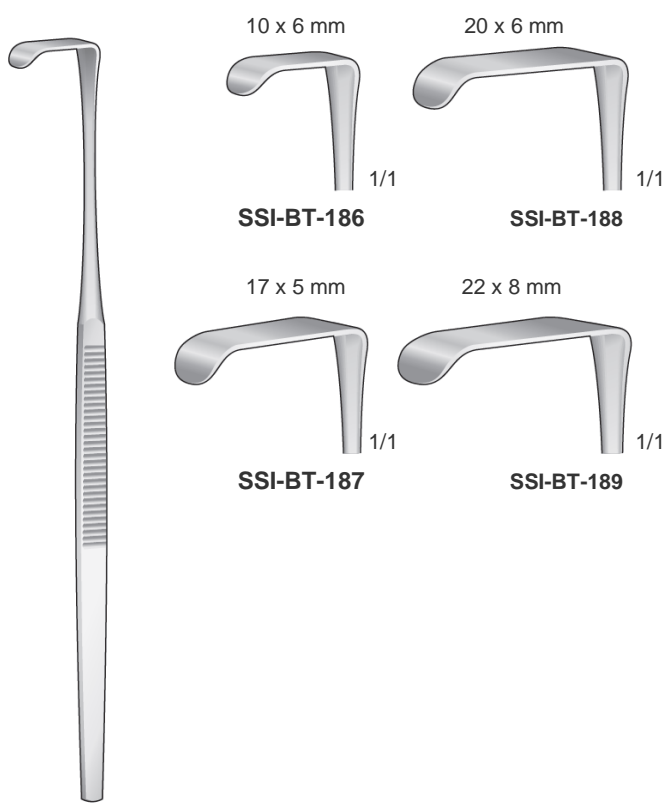
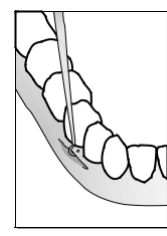
Sheffield Surgical is highly experienced Manufacturer & exporter of high quality Dental Instruments and also in the field of General Surgery, Bone Surgery an Orthopedic Instruments.



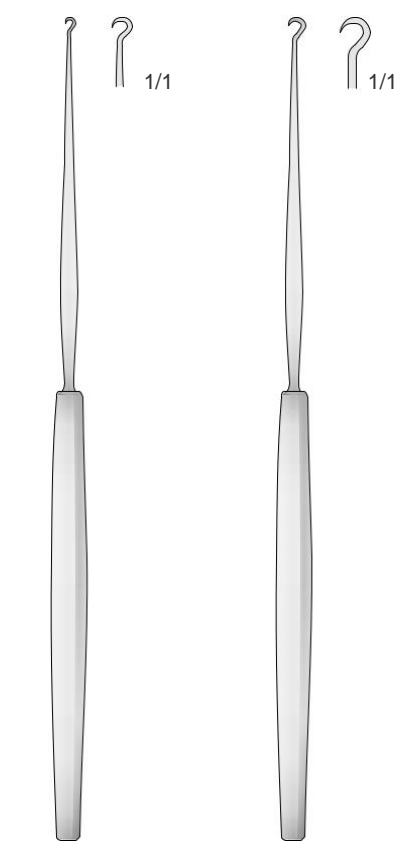
Wundhaken
Retractors
Divaricatori
Separadores
Écarteurs



JOSEPH
SSI-BT-210/SSI-BT-214
160 mm



MINI-LANGENBECK
SSI-BT-186/SSI-BT-189
160 mm



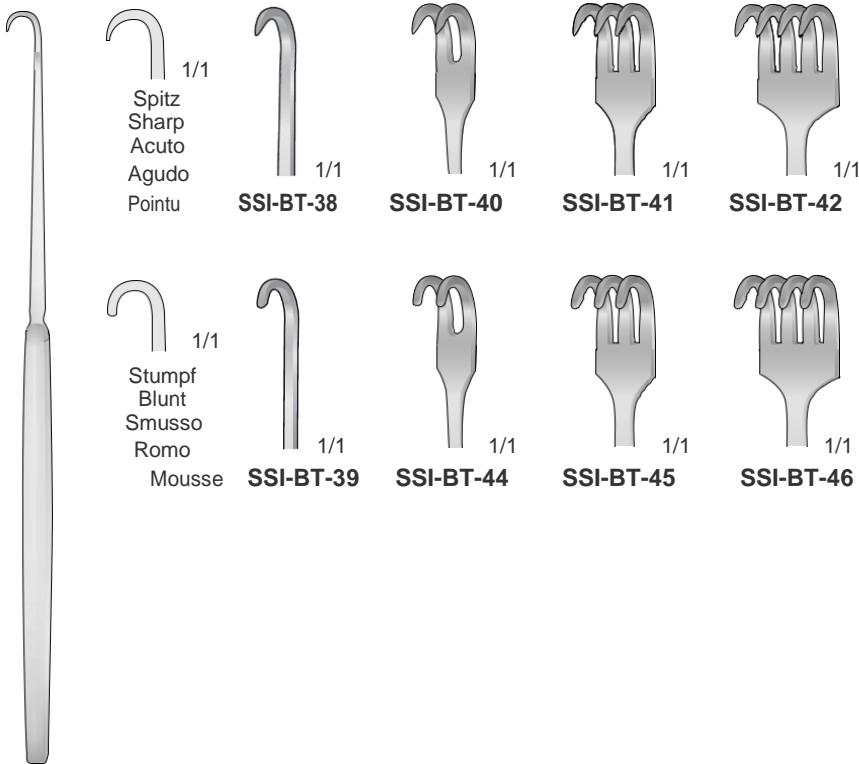
GILLIES
SSI-BT-15
180 mm

GILLIES
SSI-BT-16
180 mm

Email: sheffieldsurgicalinstruments@gmail.com
Web: www.sheffieldsurgicalinst.com



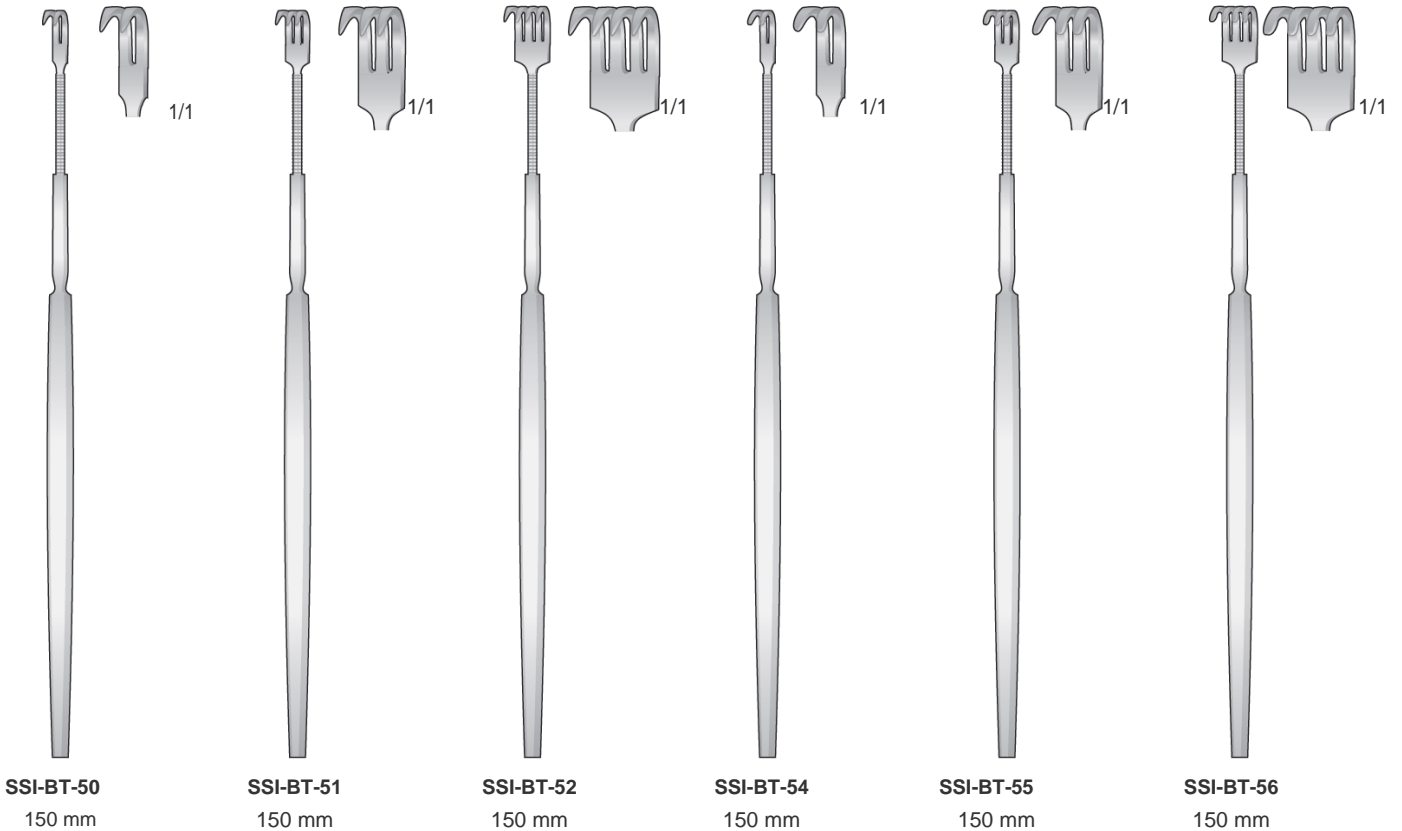
Wundhaken
Retractors
Divaricatori
Separadores
Écarteurs



SSI-BT-38/SSI-BT-46
160 mm

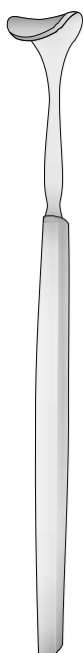
Feine wundhaken flexibel-spitz
Delicate retractors flexible-sharp
Divaricatori delicati flessibili-acuti
Separadores finos flexibles-agudos
Écarteurs fins pointu flexible

Feine wundhaken flexibel-stumpf
Delicate retractors flexible-blunt
Divaricatori delicati flessibili-smussi
Separadores finos flexibles-romos
Écarteurs fins mousse flexible

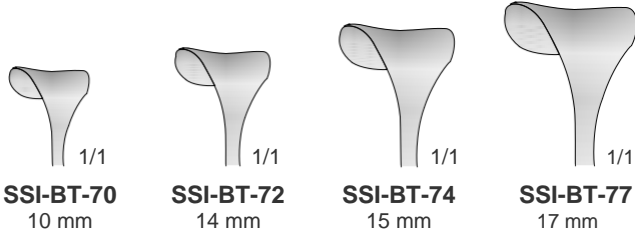


Email: sheffieldsurgicalinstruments@gmail.com
Web: www.sheffieldsurgicalinst.com

Wundhaken
Retractors
Divaricatori
Separadores
Écarteurs

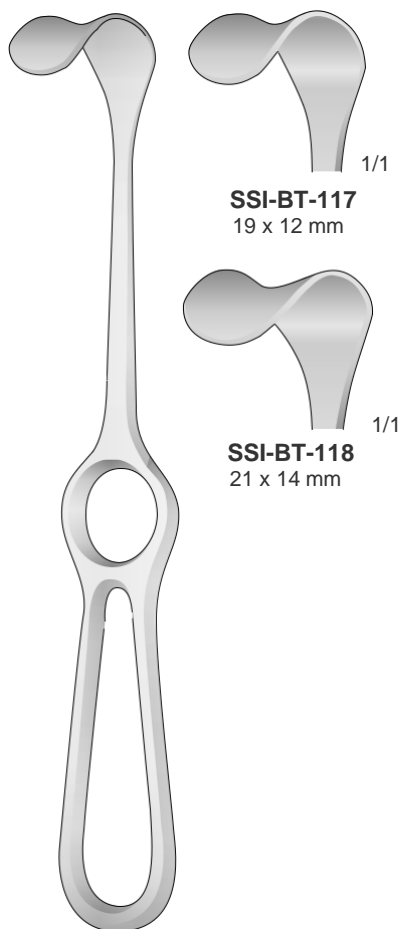


DESMARRES
SSI-BT-70/SSI-BT-77
140 mm



SEAN-MILLER
SSI-BT-18/SSI-BT-19
160 mm

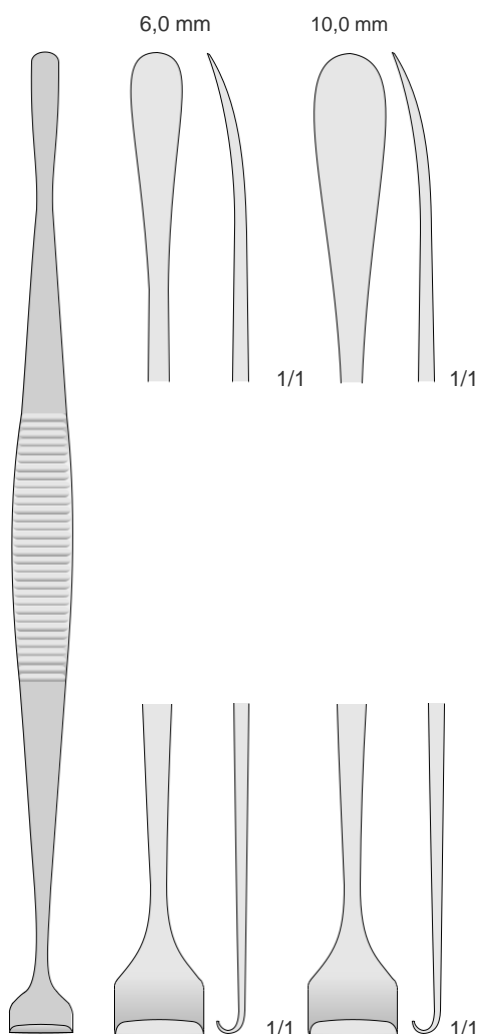
SSI-BT-18 SSI-BT-19
Spitz Sharp
Acuto Agudo
Pointu
Stumpf Blunt
Smusso Romo
Mousse



KOCHER
SSI-BT-117/BT/118
205 mm

SSI-BT-117
19 x 12 mm

SSI-BT-118
21 x 14 mm

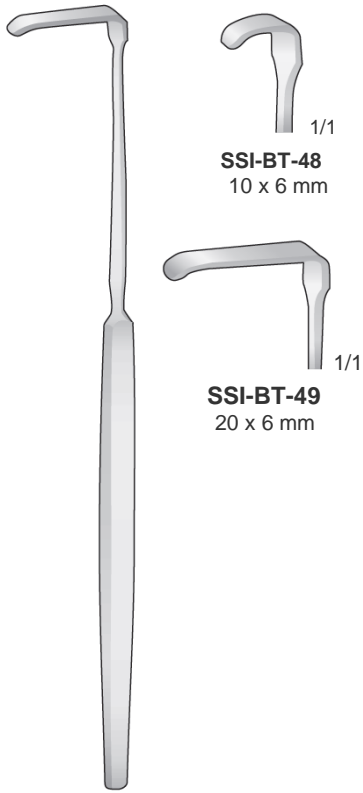


HURD
SSI-BT-1/SSI-BT-2
220 mm

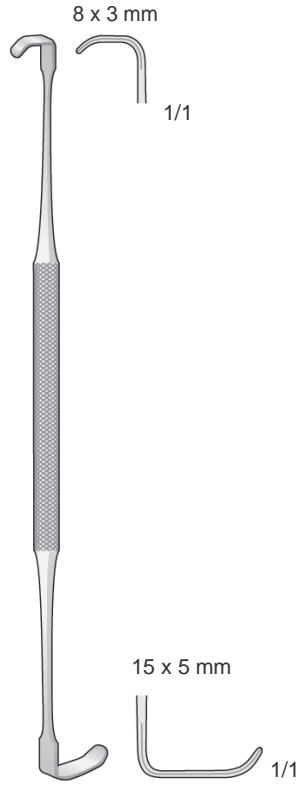
Email: sheffieldsurgicalinstruments@gmail.com
Web: www.sheffieldsurgicalinst.com



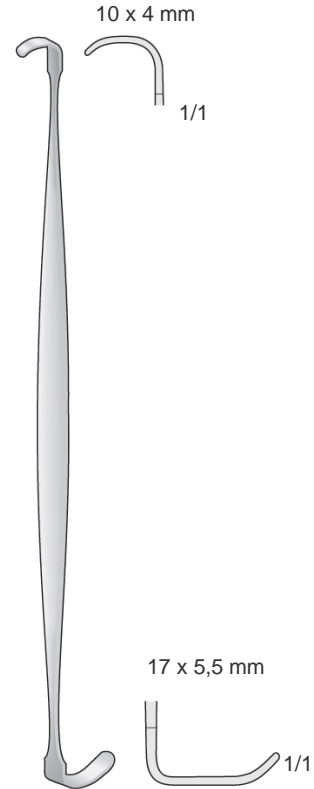
Wundhaken
Retractors
Divaricatori
Separadores
Écarteurs



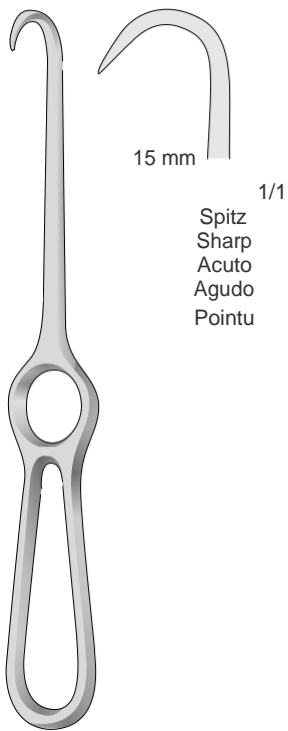
SENN GREEN
SSI-BT-48/SSI-BT-49
160 mm



RAGNELL
SSI-BT-27
140 mm

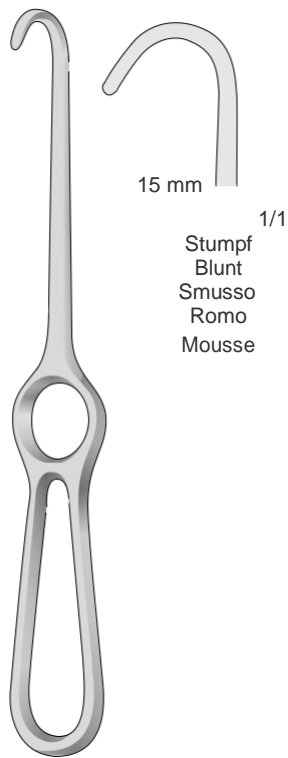


RAGNELL-DAVIS
SSI-BT-26
140 mm



KOCHER
SSI-BT-139
205 mm

15 mm 1/1
Spitz
Sharp
Acuto
Agudo
Pointu

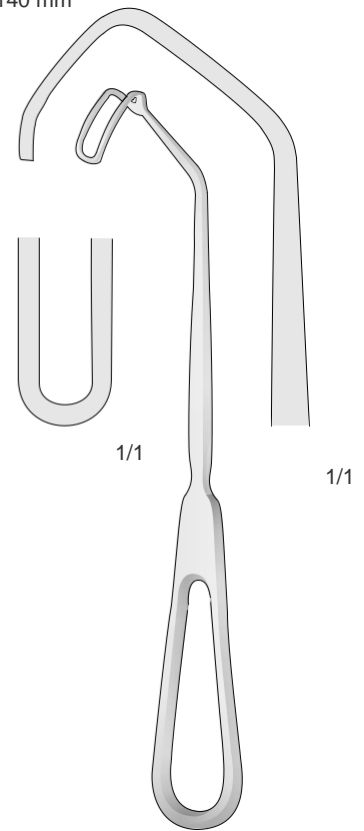


KOCHER
SSI-BT-140
220 mm

15 mm 1/1
Stumpf
Blunt
Smusso
Romo
Mousse



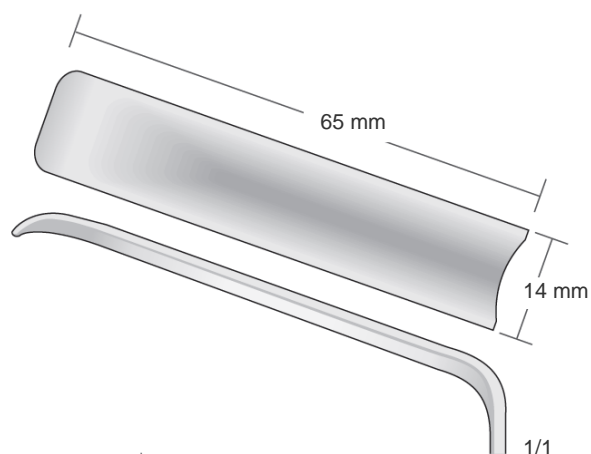
LAHEY
SSI-BT-109
195 mm



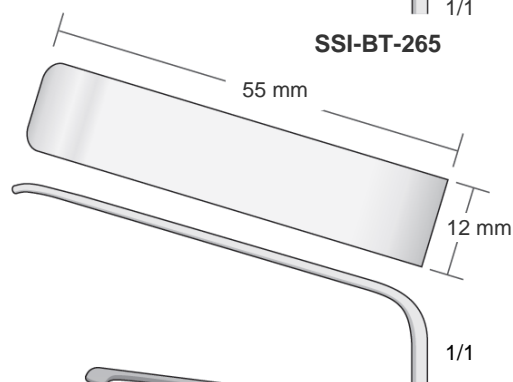
CUSHING
SSI-BT-29
200 mm

Email: sheffieldsurgicalinstruments@gmail.com
Web: www.sheffieldsurgicalinst.com

Wundhaken
 Retractors
 Divaricatori
 Separadores
 Écarteurs



SSI-BT-265



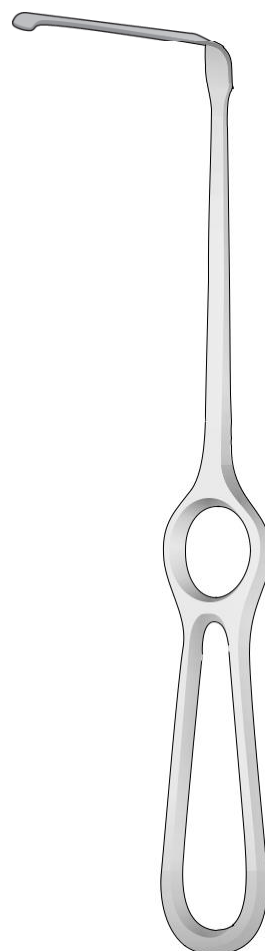
SSI-BT-264



SSI-BT-134
 40 x 12 mm

SSI-BT-135
 55 x 14 mm

DOCKHORN
SSI-BT-134/SSI-BT-135
 210 mm

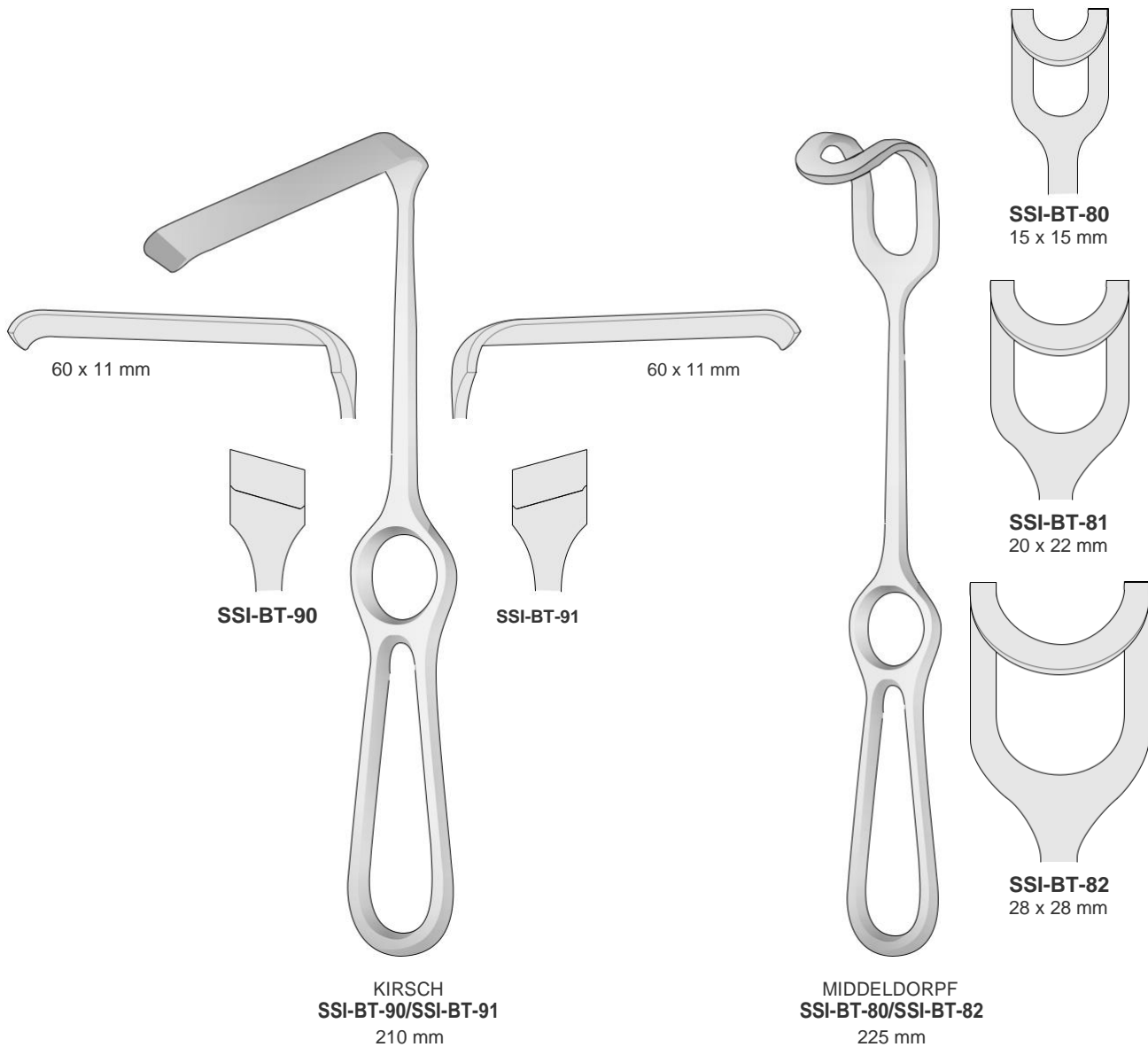


SSI-BT-264/SSI-BT-265
 235 mm

Email: sheffieldsurgicalinstruments@gmail.com
 Web: www.sheffieldsurgicalinst.com

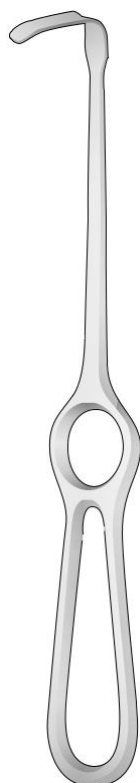


Wundhaken
Retractors
Divaricatori
Separadores
Écarteurs

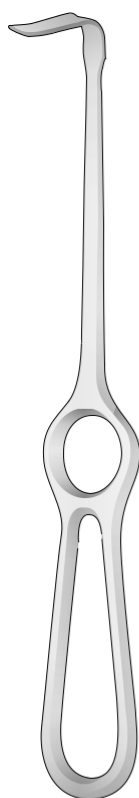


Email: sheffieldsurgicalinstruments@gmail.com
Web: www.sheffieldsurgicalinst.com

Wundhaken
 Retractors
 Divaricatori
 Separadores
 Écarteurs



OBWEGESER
SSI-BT-152/SSI-BT-157
 220 mm



OBWEGESER
SSI-BT-92/SSI-BT-100



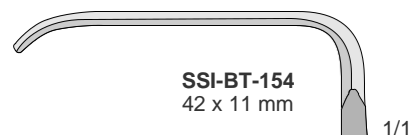
SSI-BT-152
 25 x 7 mm

1/1



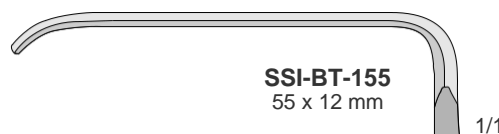
SSI-BT-153
 31 x 10 mm

1/1



SSI-BT-154
 42 x 11 mm

1/1



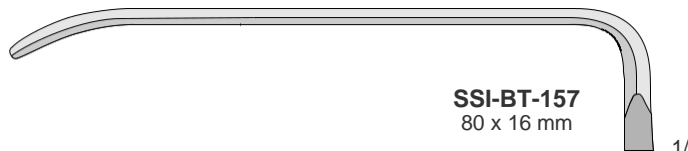
SSI-BT-155
 55 x 12 mm

1/1



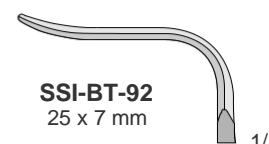
SSI-BT-156
 70 x 14 mm

1/1



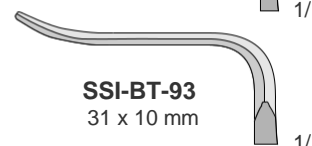
SSI-BT-157
 80 x 16 mm

1/1



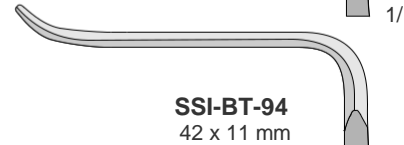
SSI-BT-92
 25 x 7 mm

1/1



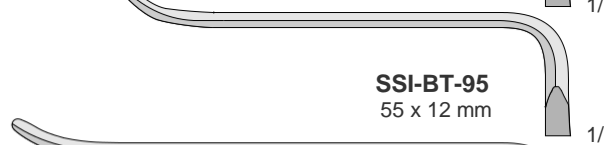
SSI-BT-93
 31 x 10 mm

1/1



SSI-BT-94
 42 x 11 mm

1/1



SSI-BT-95
 55 x 12 mm

1/1



SSI-BT-96
 70 x 14 mm

1/1



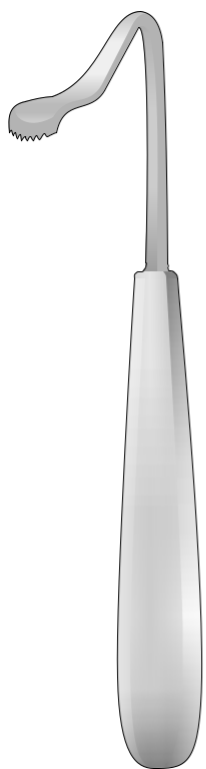
SSI-BT-100
 80 x 16 mm

1/1

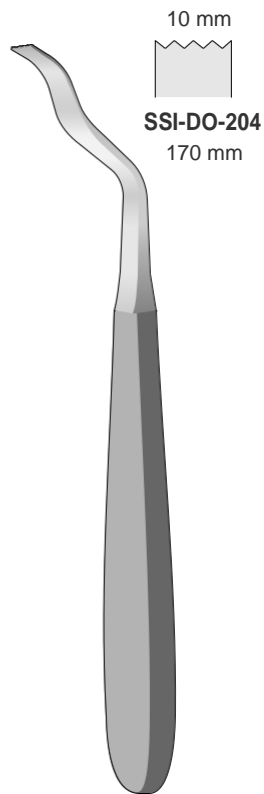
Email: sheffieldsurgicalinstruments@gmail.com
 Web: www.sheffieldsurgicalinst.com



Wundhaken
Retractors
Divaricatori
Separadores
Écarteurs



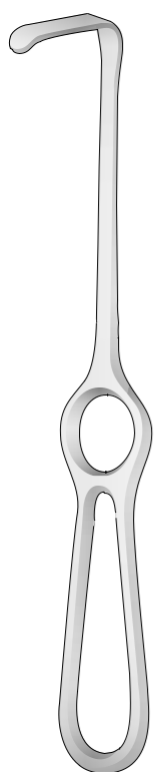
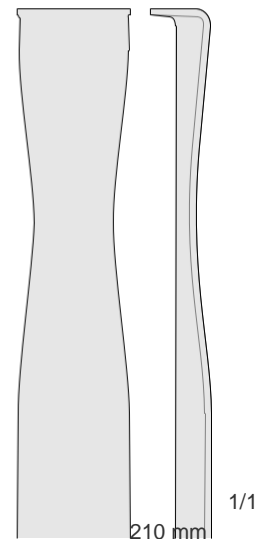
BOWLED-HENRY
SSI-DO-175
170 mm



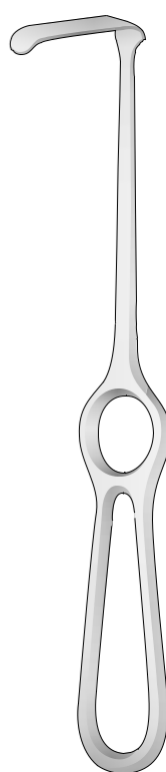
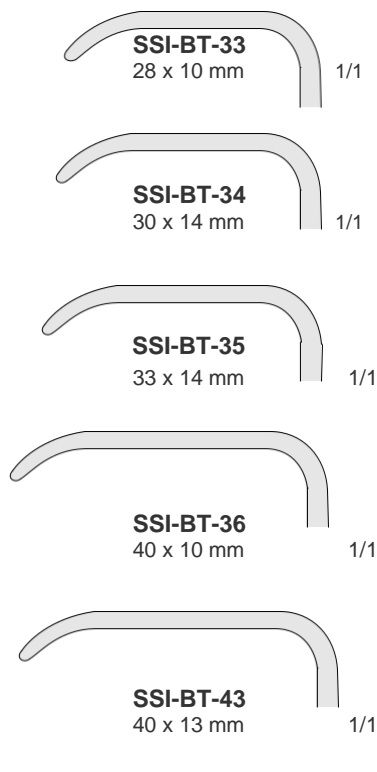
SSI-DO-204/SSI-DO-204L
170 mm



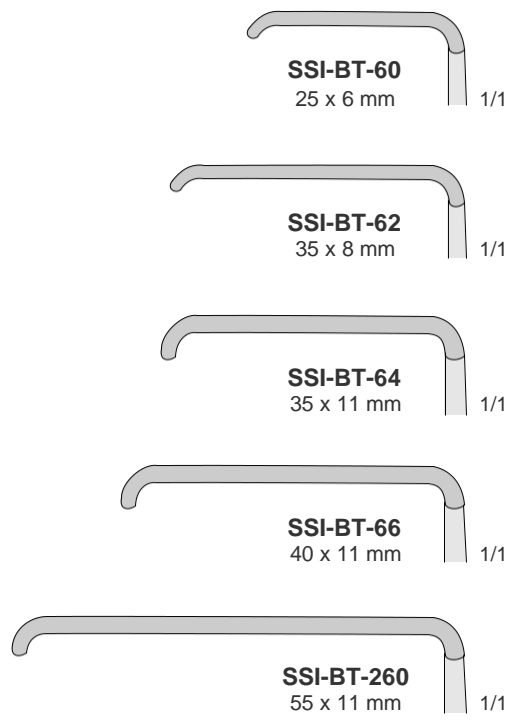
AUSTIN
SSI-DO-212
140 mm



LANGENBECK
SSI-BT-33/SSI-BT-43



KOCHER-LANGENBECK
SSI-BT-60/SSI-BT-260



Email: sheffieldsurgicalinstruments@gmail.com
Web: www.sheffieldsurgicalinst.com

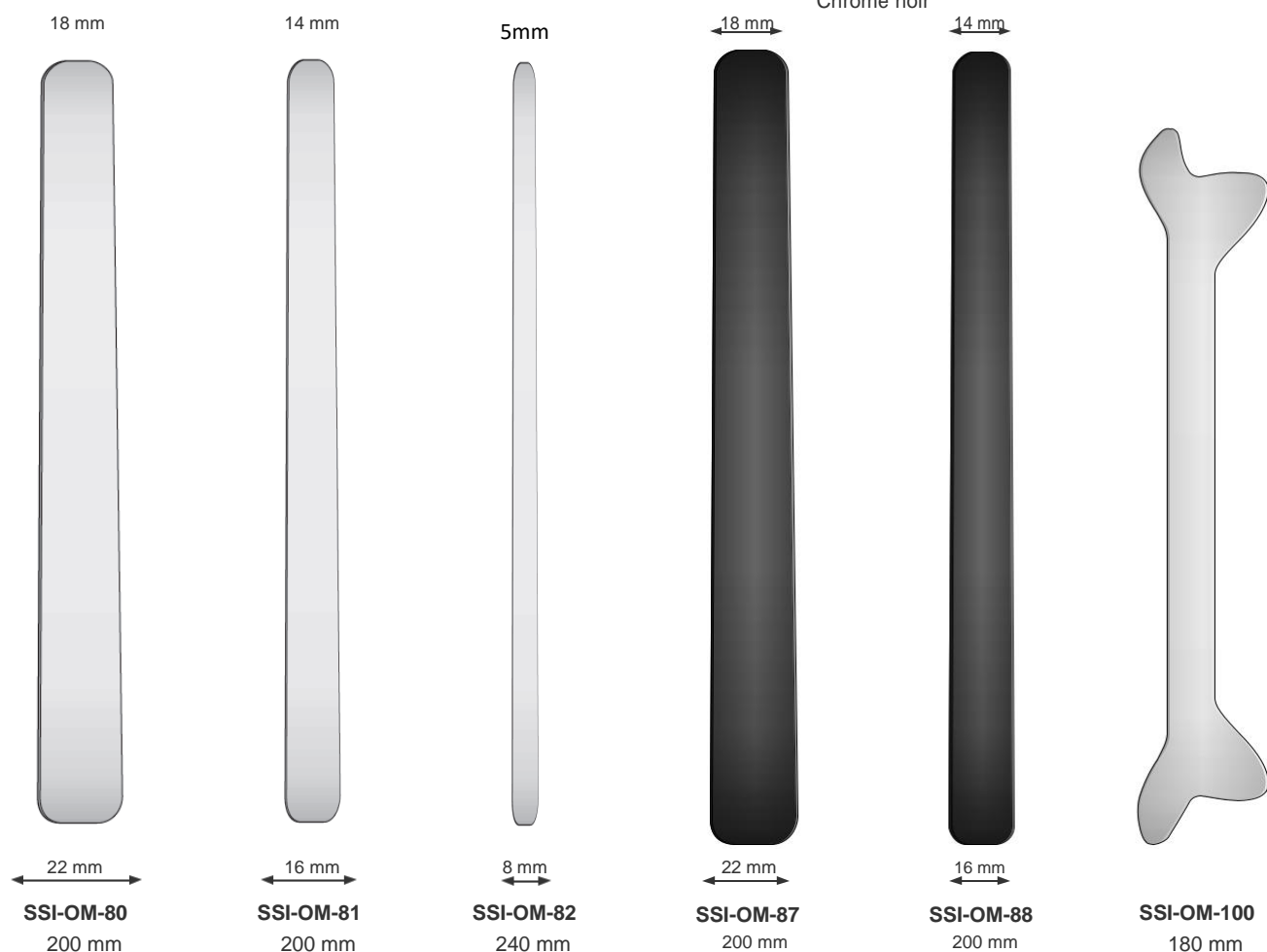
Wundhaken
 Retractors
 Divaricatori
 Separadores
 Écarteurs

Rostfrei - Stainless Steel
 Acciaio - Acero - Acer

Biegsam - Malleable
 Malleabili - Maleables
 Souples

SSI-OM-85
 Komplettsset mit 3 Spatel
 Set complete with 3 spatulas
 Set completo con 3 spatole
 Set completos con 3 espátulas
 Set complete avec 3 spatules
SSI-OM-80 + SSI-OM-81
SSI-OM-82

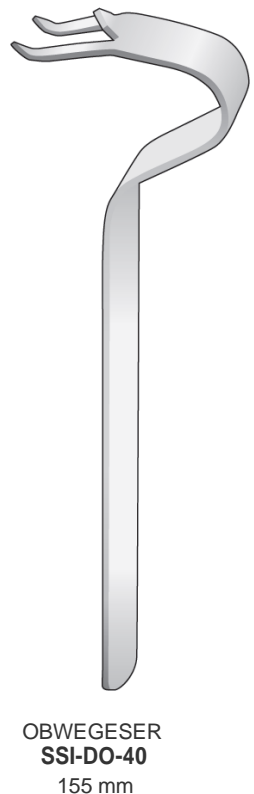
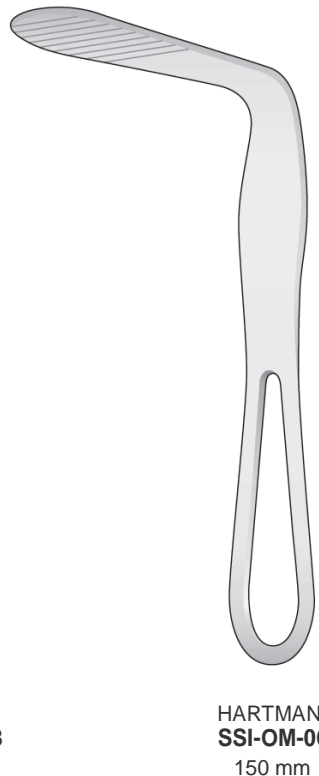
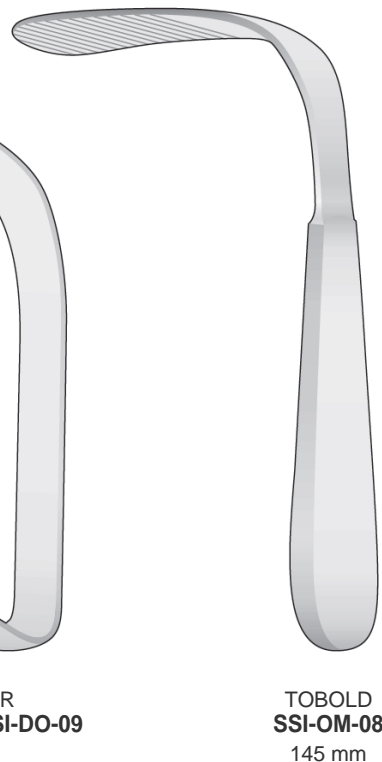
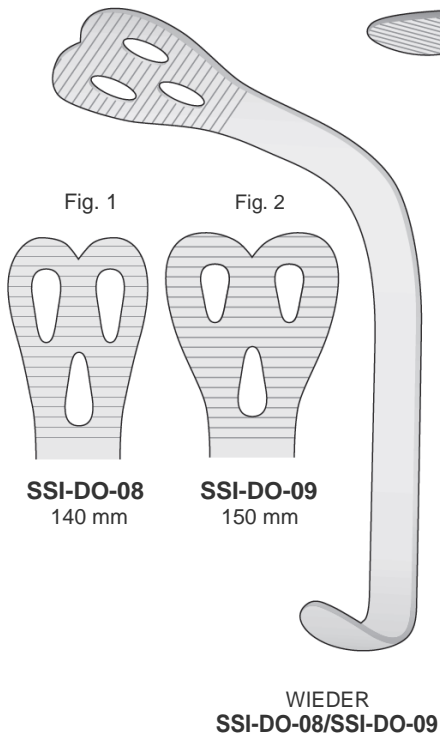
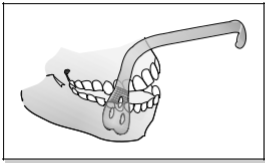
Schwarz Verchromt
 Black anodized
 Cromato nero
 Cromado en negro
 Chromé noir



Email: sheffieldsurgicalinstruments@gmail.com
 Web: www.sheffieldsurgicalinst.com

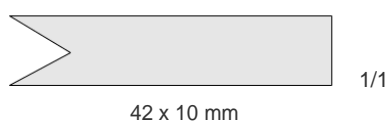
Zungendrucker
Tongue Depressors
Abbassalingua
Bajalengua
Abaisse langue

Kinnhalter
Chin Holder
Divaricatore per mento
Separador para mentón
Écarteur pour menton



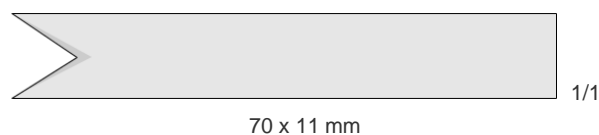
Wundhaken
Retractors
Divaricatori
Separadores
Écarteurs

Ramushaken für Spina Nasalis
Ramus Retractor for nasal spine
Divaricatori per spina nasalis
Separadores para spina nasalis
Écarteurs pour spina nasalis



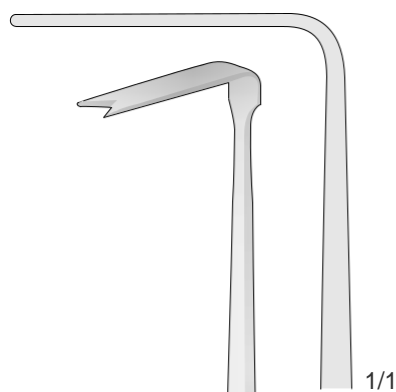
42 x 10 mm

1/1



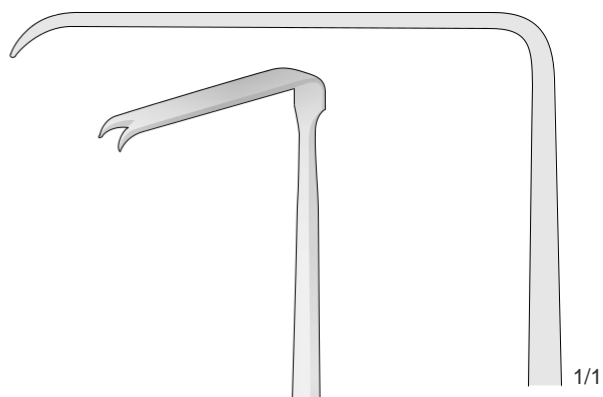
70 x 11 mm

1/1



1/1

OBWEGESER
SSI-BT-67
220 mm

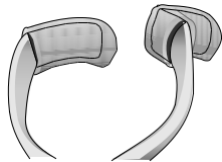


1/1

OBWEGESER
SSI-BT-68
220 mm



Mundsperrer
 Mouth gags
 Apribocca
 Abrebocas
 Écarteur buccal



Paar Einsätzen aus Silikon für:
 Pair of silicone inserts for:
 Coppia di inserti in silicone per:
 Pareja de inserto de silicone para:
 Paire de inserts en silicon pour:

SSI-OM-40 - SSI-OM-41

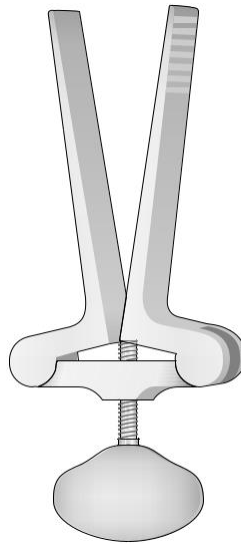
Ø 8 mm

Ø 11 mm

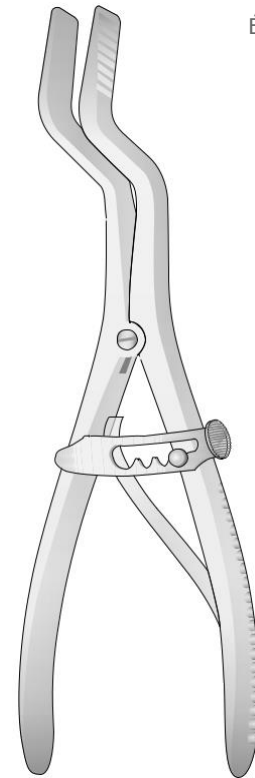


SSI-OM-40R
 30 mm

SSI-OM-41R
 30 mm

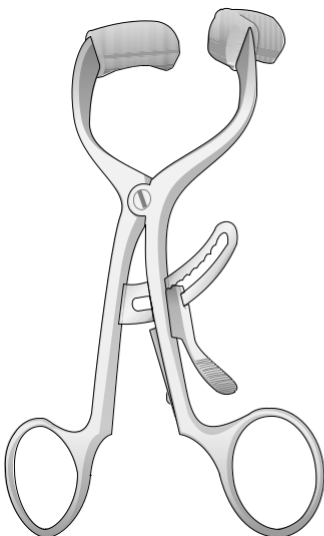


HEISTER
SSI-OM-62
 135 mm



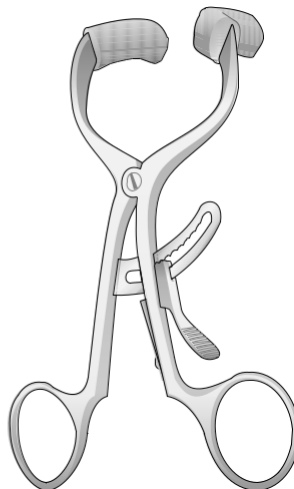
ROSER KÖNIG
SSI-OM-60
 185 mm

Für Erwachsene - For adults
 Per adulti - Para adultos
 Pour adultes



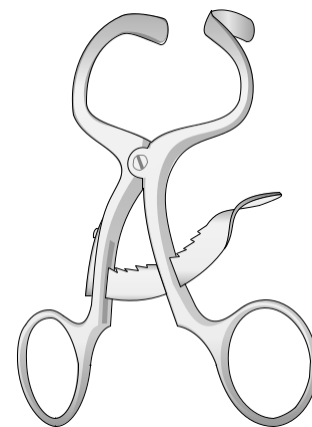
MOLT
DOYEN-JANSEN
SSI-OM-41
 140 mm

Für Erwachsene - For adults
 Per adulti - Para adultos
 Pour adultes



MOLT
DOYEN-COLLIN
SSI-OM-40
 120 mm

Für Kinder
 For children
 Per bambini
 Para niños
 Pour enfants



MOLT
SSI-OM-42
 100 mm

Email: sheffieldsurgicalinstruments@gmail.com
 Web: www.sheffieldsurgicalinst.com

Mundsperrer
 Mouth gags
 Apribocca
 Abrebocas
 Écarteur buccal

Abhalter für gesamten Ober-bzw. Unterkiefer
 Retractor for complete upper resp. Lower jaws
 Retrattore per arcata superiore e inferiore intera
 Separadores para quijadas enteras inferiores y superiores
 Écarteurs pour machoires complètes inférieures et supérieures

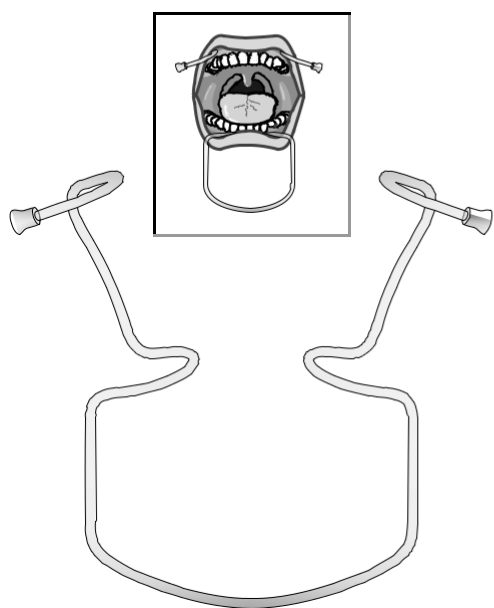
100 x 95 mm

SSI-OM-74 Fig. 0

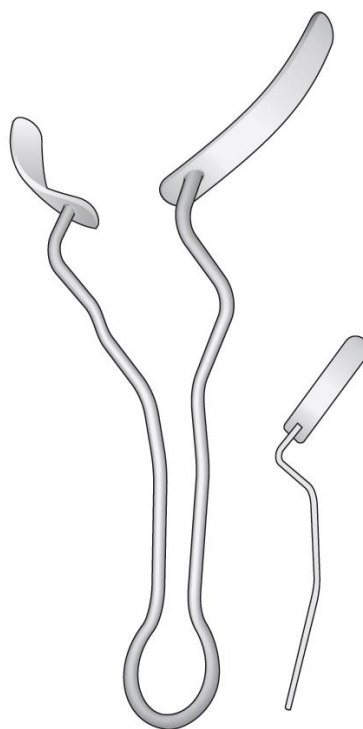
SSI-OM-75 Fig. 1 115 x 105 mm

SSI-OM-76 Fig. 2 115 x 110 mm

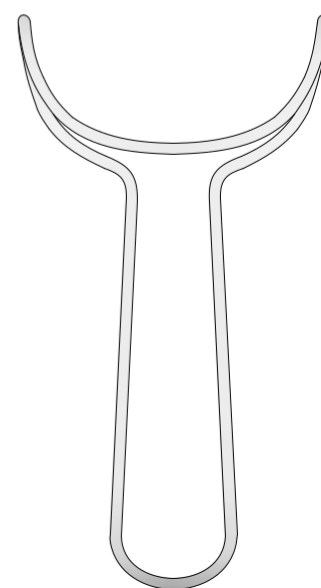
SSI-OM-77 Fig. 3 125 x 115 mm



ORINGER
SSI-OM-74/SSI-OM-77



MATY
SSI-OM-97
 170 mm



SSI-OM-90
 150 mm

Email: sheffieldsurgicalinstruments@gmail.com
 Web: www.sheffieldsurgicalinst.com



Wundhaken
Retractors
Divaricatori
Separadores
Écarteurs

SSI-BT-283
Set completo
Set complete
Kompletset
Set complet
Set completo
SSI-BT-284 + SSI-BT-285
SSI-BT-286



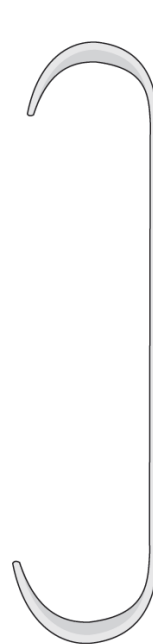
29 mm
26 mm
22 mm

28 mm
38 mm
44 mm

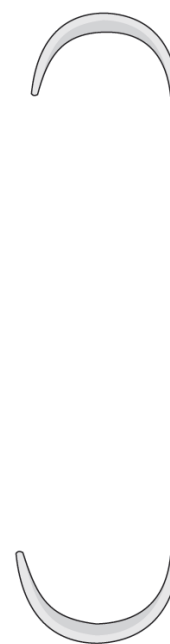
ROUX
SSI-BT-283
165 mm



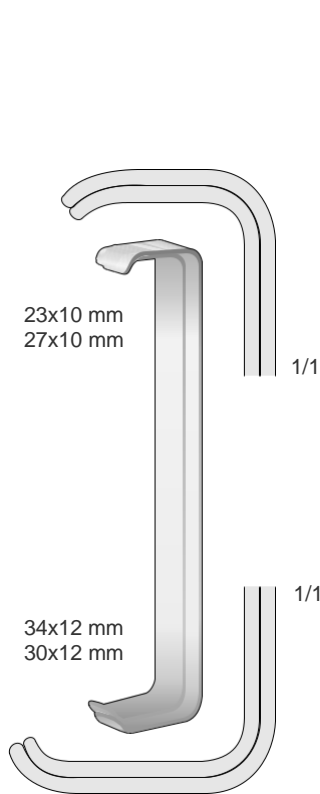
ROUX
SSI-BT-284
20x22 mm
25x28 mm



ROUX
SSI-BT-285
23x26 mm
29x38 mm



ROUX
SSI-BT-286
29x29 mm
34x44 mm



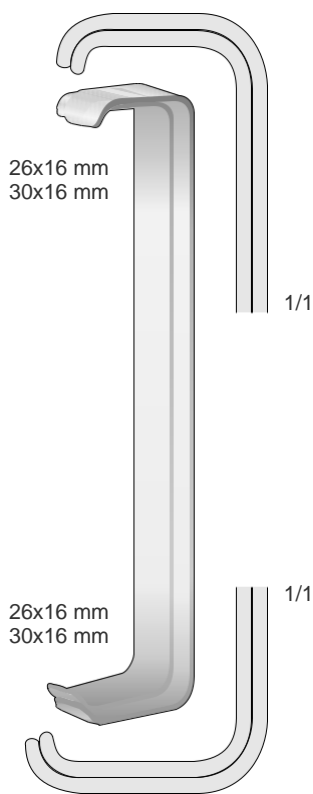
23x10 mm
27x10 mm

1/1

34x12 mm
30x12 mm

1/1

FARABEUF
SSI-BT-20
120 mm



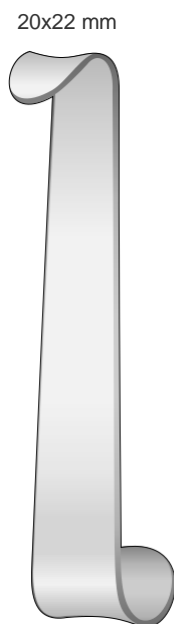
26x16 mm
30x16 mm

1/1

26x16 mm
30x16 mm

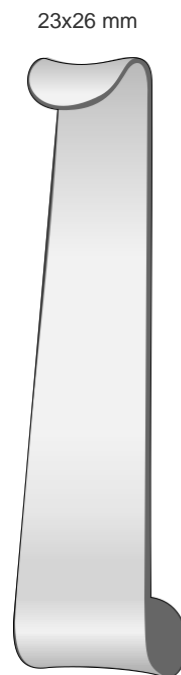
1/1

FARABEUF
SSI-BT-25
150 mm



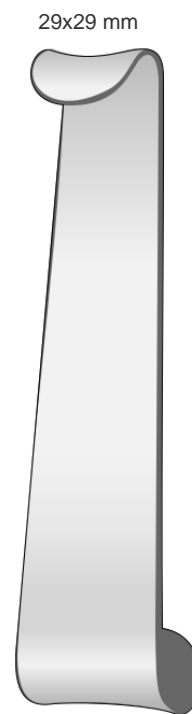
20x22 mm

25x28 mm
ROUX-MAGNUS
SSI-BT-287
150 mm



23x26 mm

29x38 mm
ROUX-MAGNUS
SSI-BT-288
160 mm

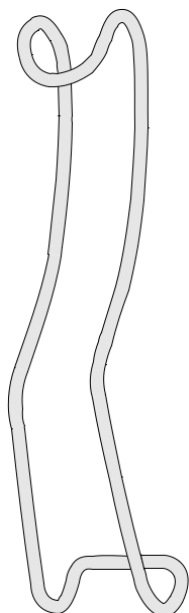


29x29 mm

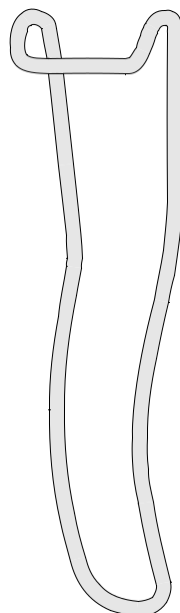
34x44 mm
ROUX-MAGNUS
SSI-BT-289
170 mm

Email: sheffieldsurgicalinstruments@gmail.com
Web: www.sheffieldsurgicalinst.com

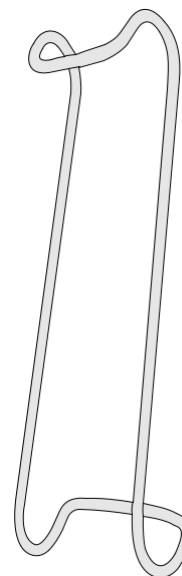
Wangenhalter Cheek
Retractors Divaricatori
per guance Separador
para mejillas Écarteurs
des joues



**STERNBERG
SSI-OM-50**
160 mm

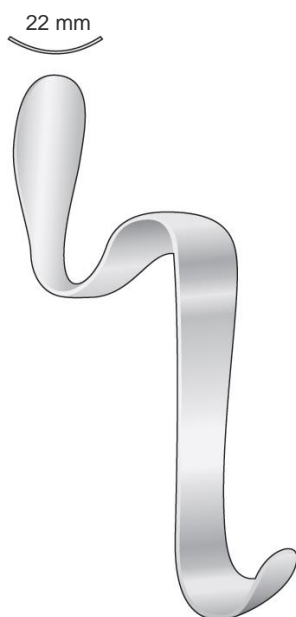


**STERNBERG
SSI-OM-52**
160 mm



**COLUMBIA
SSI-OM-67**
140 mm

Schwarz Verchromt
Black anodized
Cromato nero
Cromado en negro
Chromé noir



**BISHOP
SSI-OM-61**
130 mm



**MINNESOTA
SSI-OM-55**
140 mm



**CAWOOD-MINNESOTA
SSI-OM-66**
160 mm



**MINNESOTA
SSI-OM-55B**
140 mm

**NEW
BLACK**

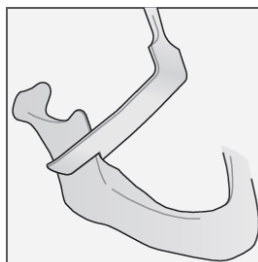


**CAWOOD-MINNESOTA
SSI-OM-66B**
160 mm

Email: sheffieldsurgicalinstruments@gmail.com
Web: www.sheffieldsurgicalinst.com



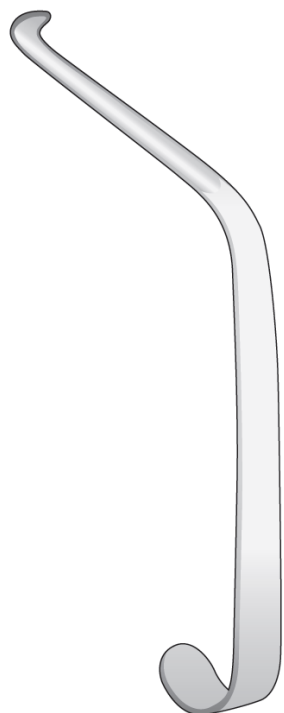
Wundhaken
Retractors
Divaricatori
Separadores
Écarteurs



Ramus Retraktoren Recht
Ramus Retractor Right
Retrattore Ramus destro
Separadores Ramus derecho
Écarteur Ramus droites

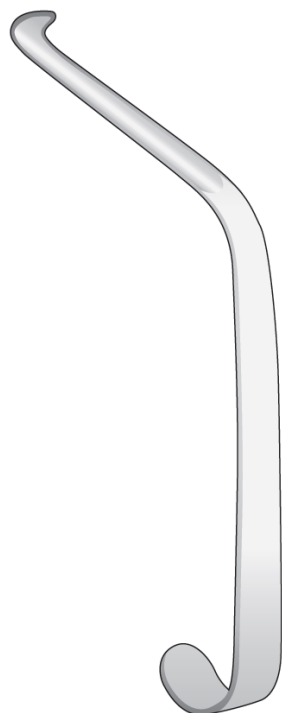
Ramus Retraktoren Link
Ramus Retractor Left
Retrattore Ramus sinistro
Separadores Ramus izquierdo
Écarteur Ramus gauches

8 mm



OBWEGESER
SSI-DO-41
165 mm

10 mm



OBWEGESER
SSI-DO-142
165 mm



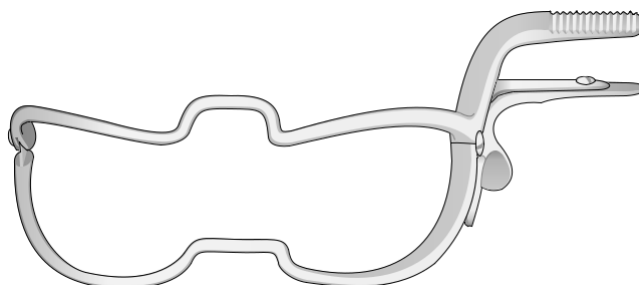
MISCH
SSI-BT-158
210 mm



MISCH
SSI-BT-159
210 mm

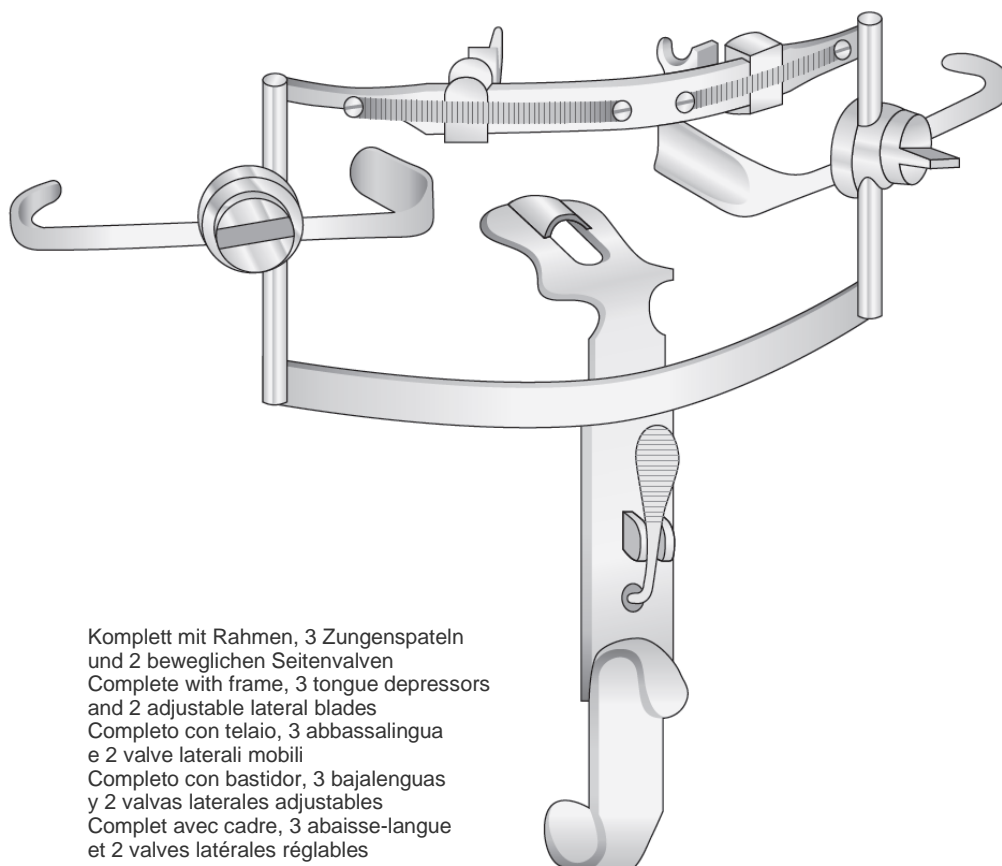
Email: sheffieldsurgicalinstruments@gmail.com
Web: www.sheffieldsurgicalinst.com

Mundsperrer
 Mouth Gags
 Apribocca
 Abrebocas
 Écarteur buccal



WHITEHEAD-JENNINGS

- SSI-OM-136** 90 mm
- SSI-OM-137** 110 mm
- SSI-OM-138** 130 mm
- SSI-OM-139** 150 mm



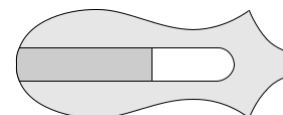
Komplett mit Rahmen, 3 Zungenspateln
 und 2 beweglichen Seitenvälven
 Complete with frame, 3 tongue depressors
 and 2 adjustable lateral blades
 Completo con telaio, 3 abbassalingua
 e 2 valve laterali mobili
 Completo con bastidor, 3 bajalenguas
 y 2 valvas laterales ajustables
 Complet avec cadre, 3 abaisse-langue
 et 2 valves latérales réglables

DINGMANN
SSI-OM-110
 Set completo

DINGMANN

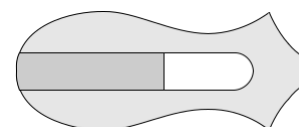
Zungenspatel
 Tongue depressor
 Abbassalingua
 Bajalengua
 Abaisse langue

Fig. 1



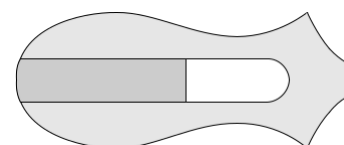
SSI-OM-112
 65 x 25 mm

Fig. 2

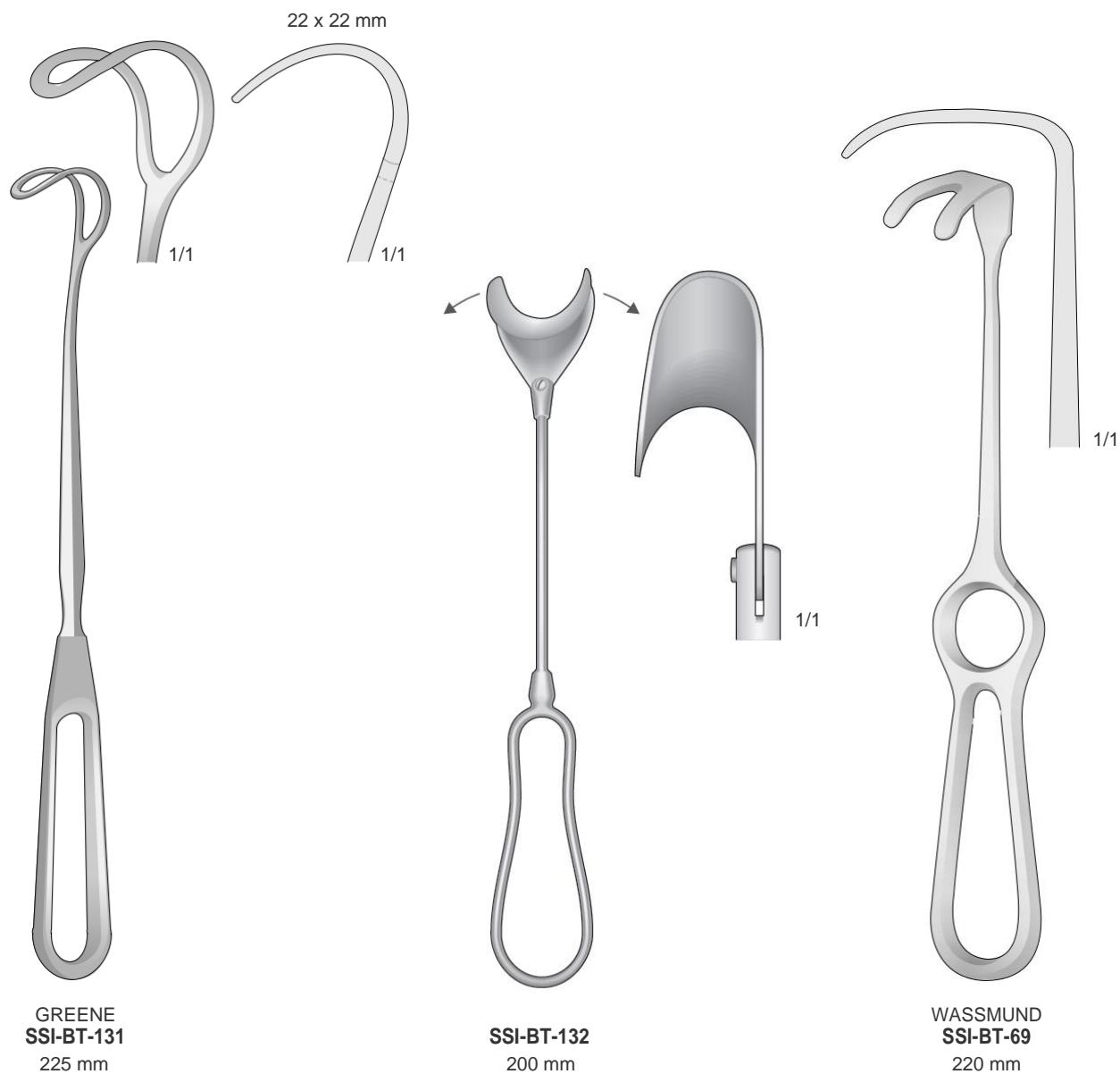


SSI-OM-113
 70 x 29 mm

Fig. 3

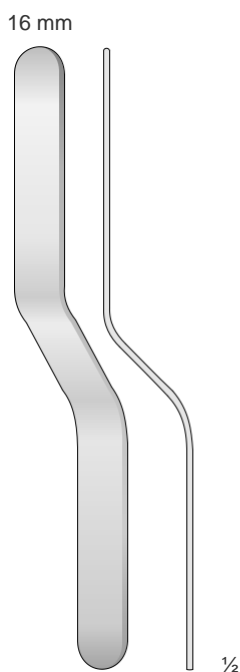


SSI-OM-114
 80 x 32 mm

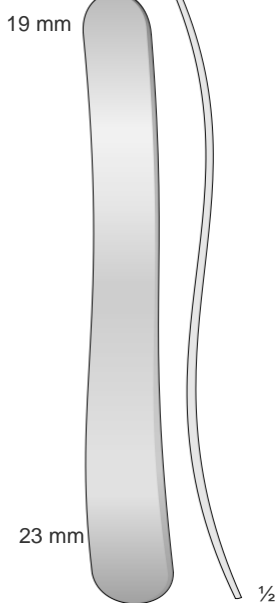


Email: sheffieldsurgicalinstruments@gmail.com
Web: www.sheffieldsurgicalinst.com

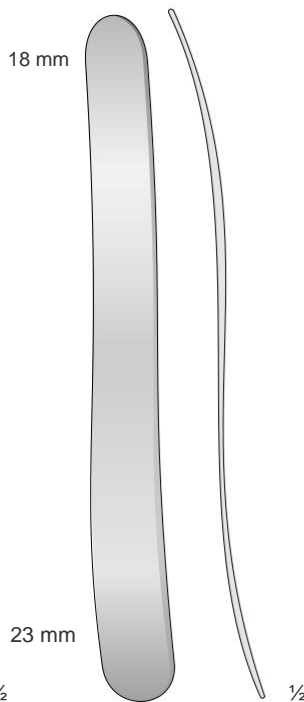
Zungenspatel - Zungenzangen
 Tongue Depressors - Tongue Holding Forceps
 Abbassalingua - Pinze tiralingua
 Bajalenguas - Pinzas tira-lengua
 Abaisse langues - Pincés tire-langue



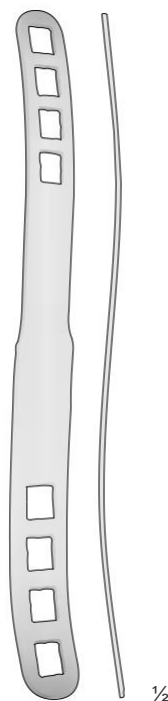
SSI-OM-07
145 mm



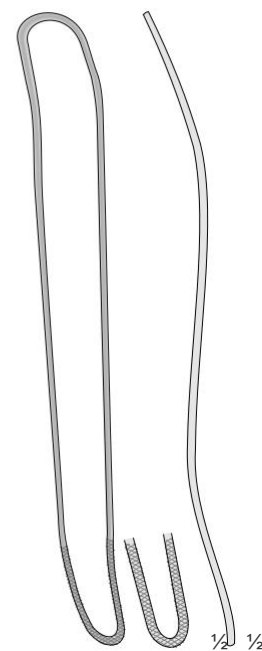
KROENIG SSI-OM-16
150 mm



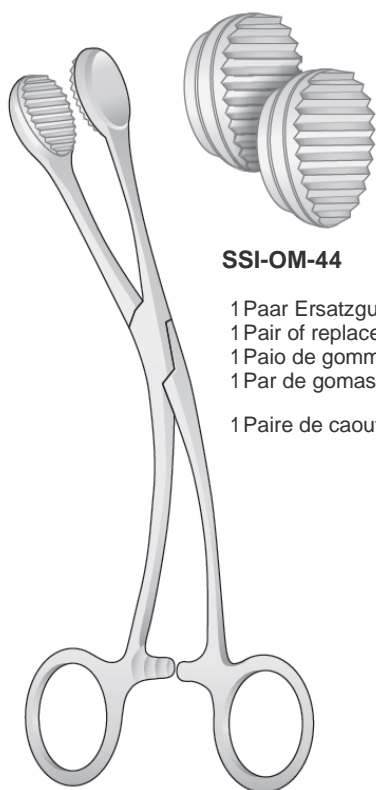
BUCHWALD SSI-OM-18
180 mm



BRUENINGS SSI-OM-04
190 mm



FRENZEL SSI-OM-19
165 mm

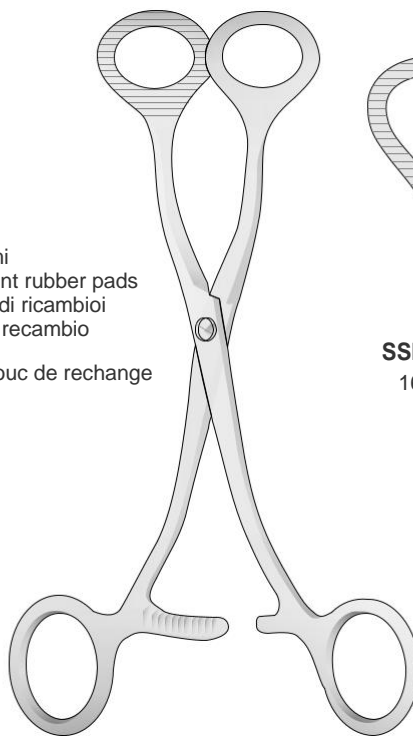


YOUNG SSI-OM-45
160 mm

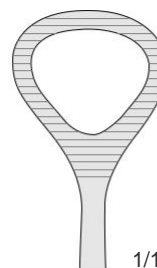
SSI-OM-44

- 1 Paar Ersatzgummi
- 1 Pair of replacement rubber pads
- 1 Paio de gommini di ricambioi
- 1 Par de gomas de recambio

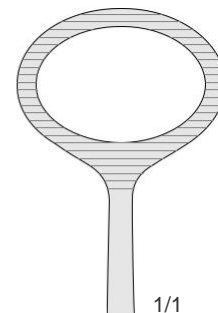
1 Paire de caoutchouc de rechange



COLLIN SSI-OM-10/SSI-OM-30



SSI-OM-30
165 mm

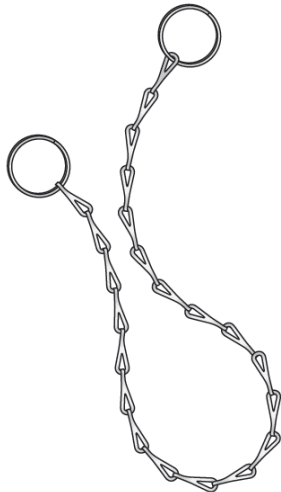


SSI-OM-10
170 mm

Email: sheffieldsurgicalinstruments@gmail.com
 Web: www.sheffieldsurgicalinst.com



Kette und Mundstutzen
Chain and Mouth Props
Catene e Apribocca
Cadena y Abrebocas
Chaîne et Ouvre Bouche



SSI-KE-20
200 mm



SSI-KE-40
400 mm

Dampfsterilisation bis 134°C
Autoclavable to 134°C
Autoclavabile a 134°C
Autoclave hasta 134°C
Autoclavable jusqu'à 134°C

Packung mit 2 Stück
Package with 2 units
Confezione da 2 pezzi
Caja con 2 unidades
Boîte avec 2 pièces

Schwarzer Gummi
Black Rubber
Gomma nera
Caucho negro
Caoutchouc noir



SSI-OM-70
SMALL
Klein, für Kinder
Small, for children
Piccolo, per bambini
Pequeño, para niños
Petit, pour enfants



SSI-OM-71
MEDIUM
Normal, für Erwachsene
Regular, for adults
Normale, per adulti
Regular, para adultos
Regulier, pour adultes

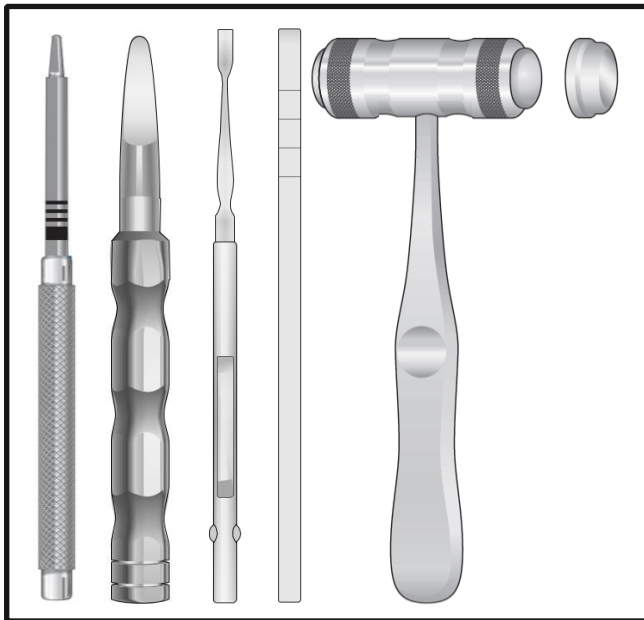


SSI-OM-72
LARGE
Groß, für Erwachsene
Large, for adults
Grande, per adulti
Grande, para adultos
Grand, pour adultes

Email: sheffieldsurgicalinstruments@gmail.com
Web: www.sheffieldsurgicalinst.com



Implantology
Implantologie
Implantologie
Implantología
Implantologia

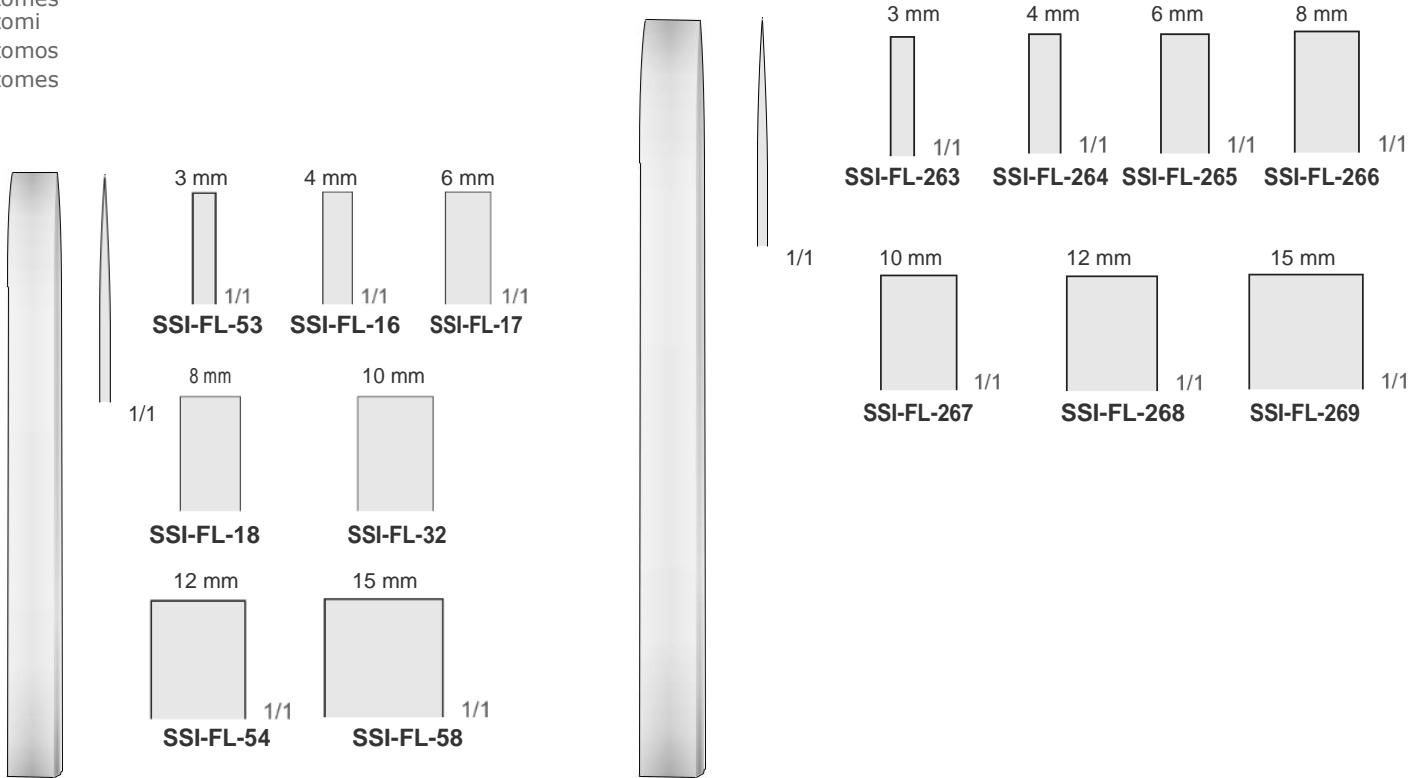


Sheffield Surgical is highly experienced Manufacturer & exporter of high quality Dental Instruments and also in the field of General Surgery, Bone Surgery an Orthopedic Instruments.



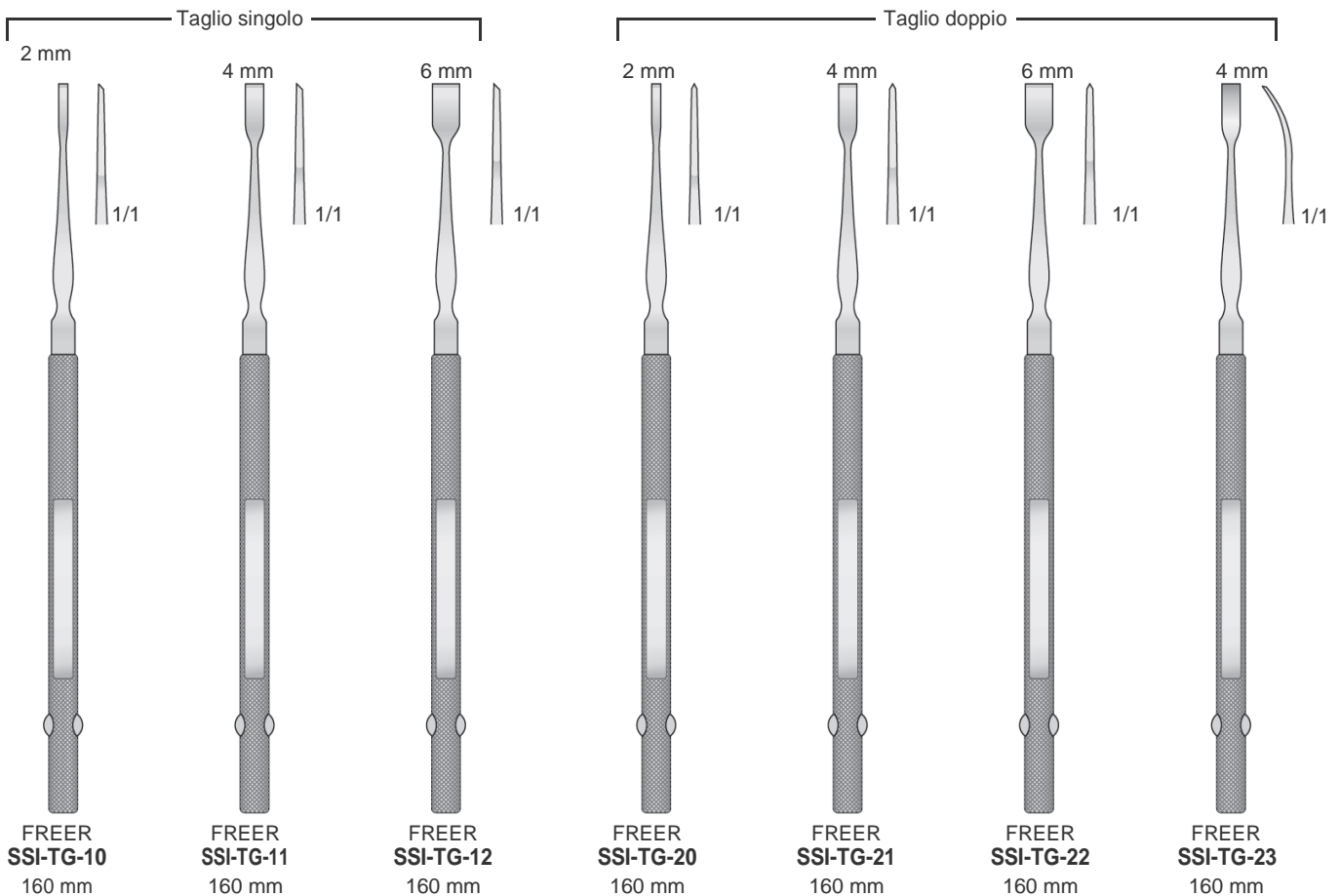
Email: sheffieldsurgicalinstruments@gmail.com
Web: www.sheffieldsurgicalinst.com

Osteotome
Osteotomes
Osteotomi
Osteótomos
Ostéotomes



MINI-LAMBOTTE
SSI-FL-16/SSI-FL-58
125 mm

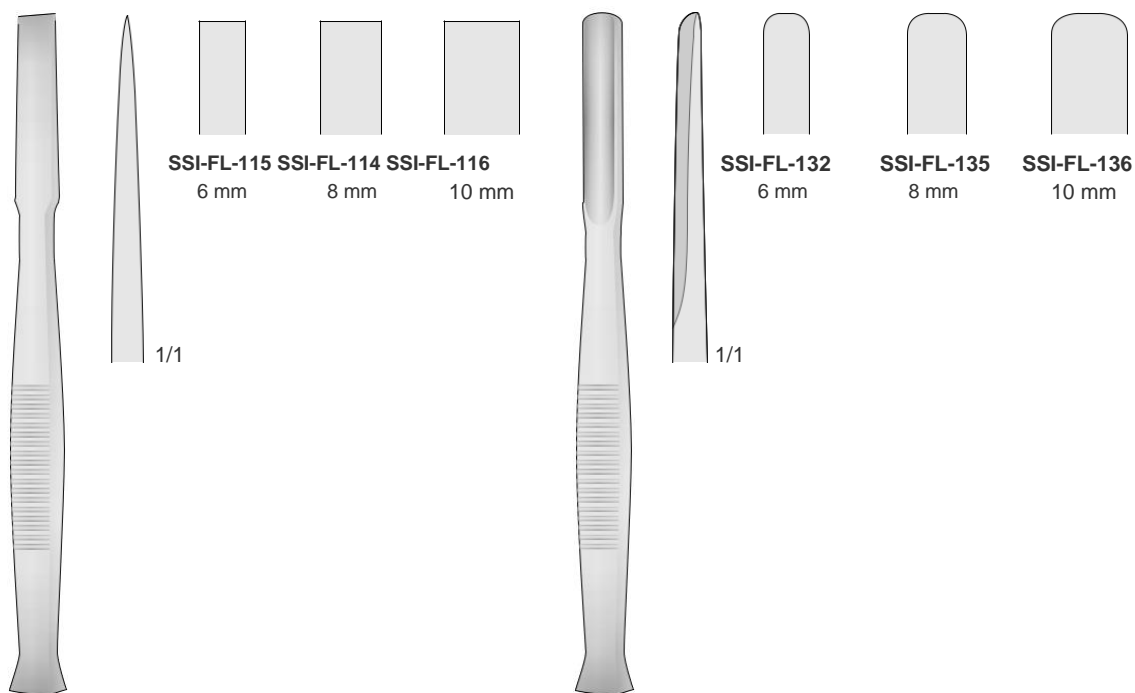
MINI-LAMBOTTE
SSI-FL-263/SSI-FL-269
170 mm



Email: sheffieldsurgicalinstruments@gmail.com
Web: www.sheffieldsurgicalinst.com

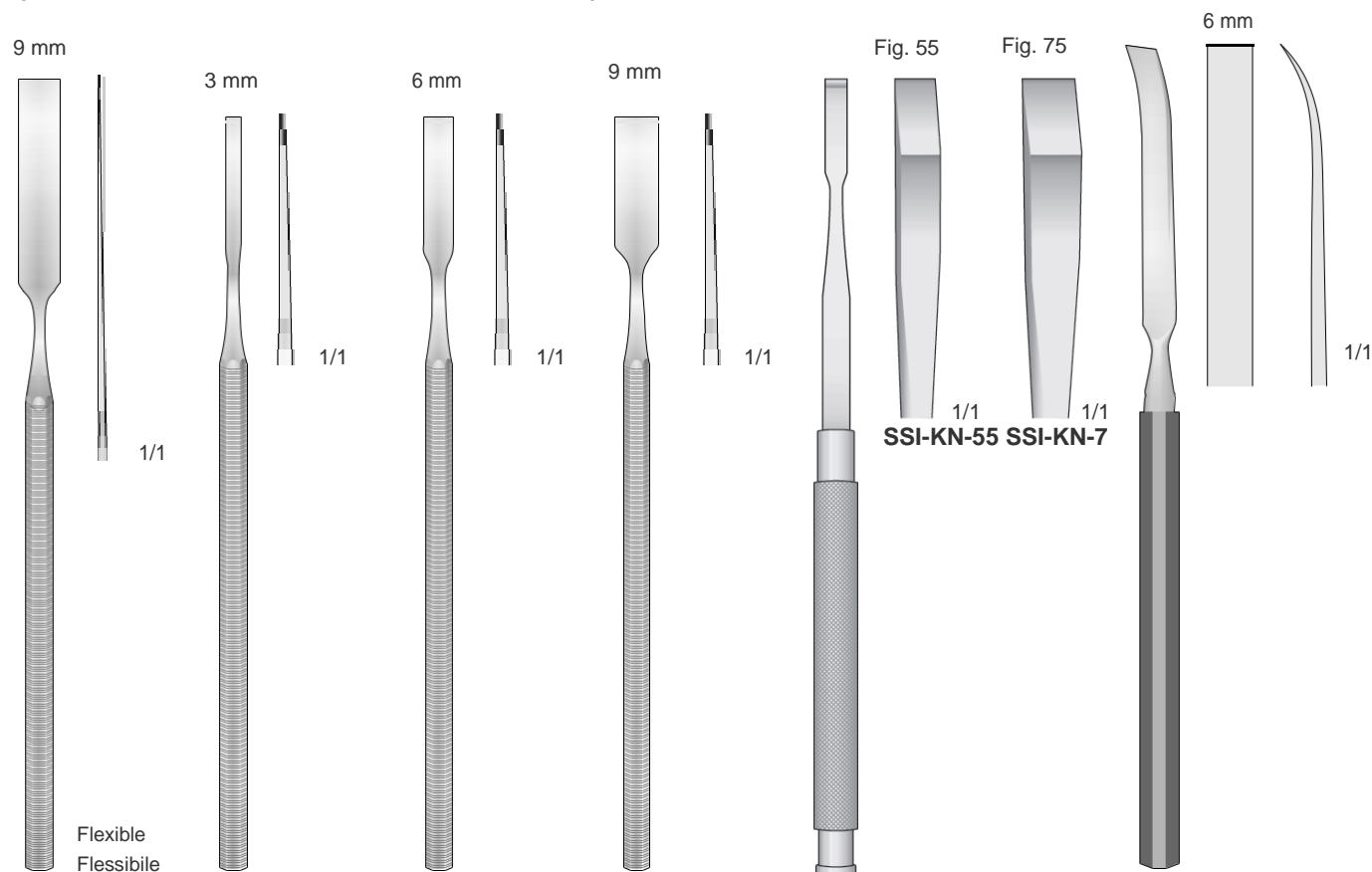


Osteotome - Meißel
 Osteotomes - Gouges
 Osteotomi - Sgorbie
 Osteótomos - Gubias
 Ostéotomes - Gouges



SSI-FL-114/SSI-FL-116
 140 mm

SSI-FL-132/SSI-FL-136
 140 mm



SSI-TG-15
 170 mm

SSI-TG-30
 155 mm

SSI-TG-31
 155 mm

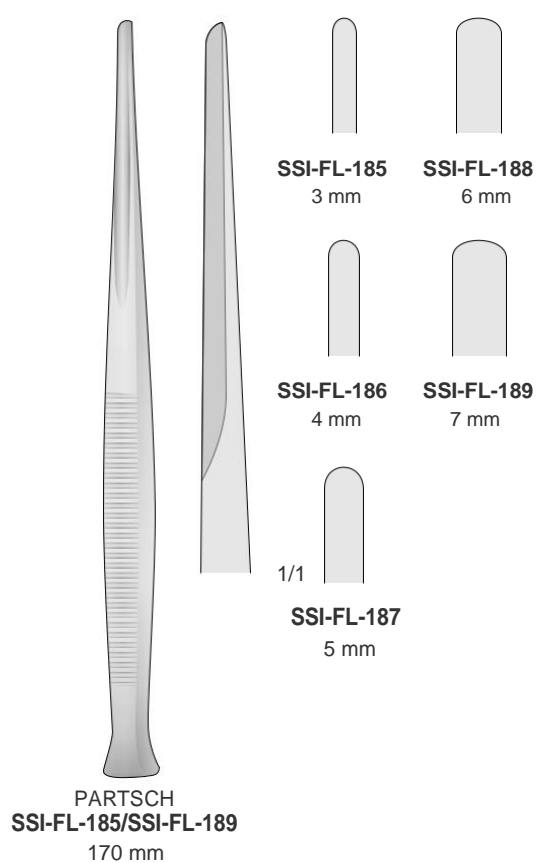
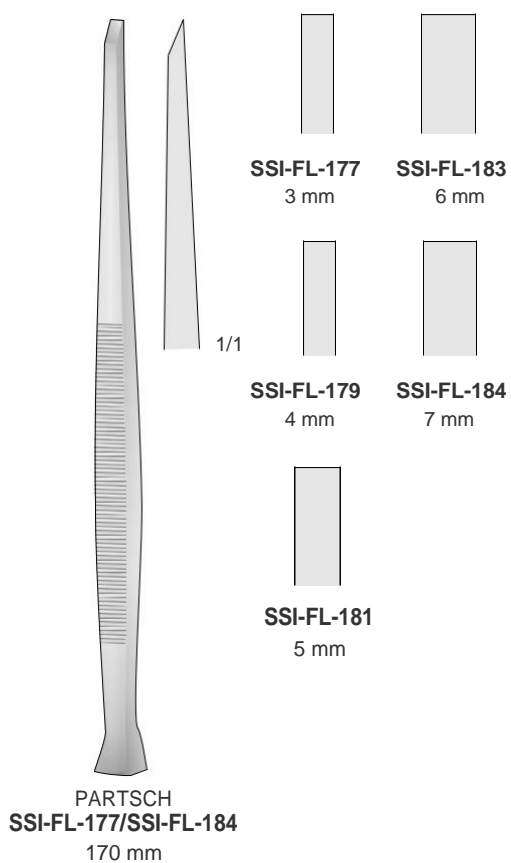
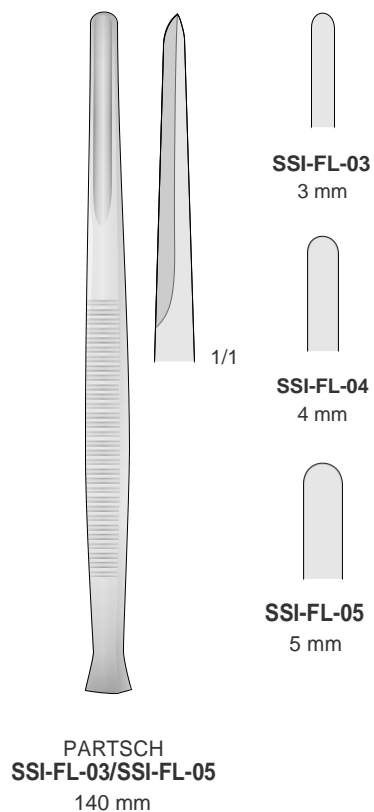
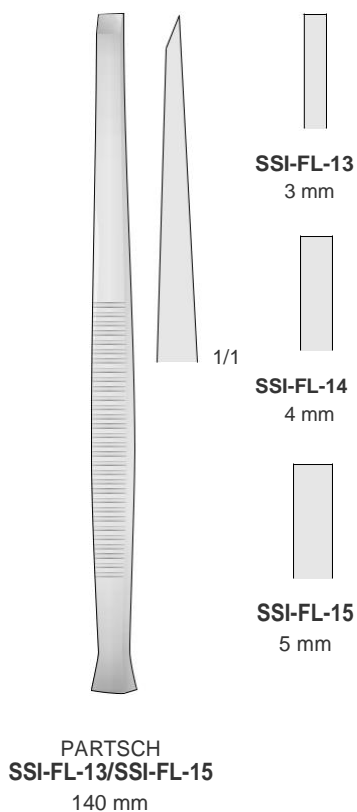
SSI-TG-32
 155 mm

KRAMER-NEVINS
 SSI-KN-55/SSI-KN-75
 175 mm

SSI-DO-196
 180 mm

Email: sheffieldsurgicalinstruments@gmail.com
 Web: www.sheffieldsurgicalinst.com

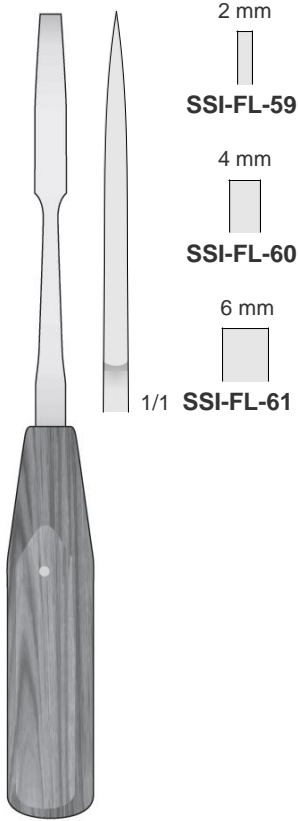
Osteotome - Hohlmeissel
 Osteotomes - Gouges
 Osteotomi - Scalpelli
 Osteótomos - Cinceles
 Ostéotomes - Scalpel



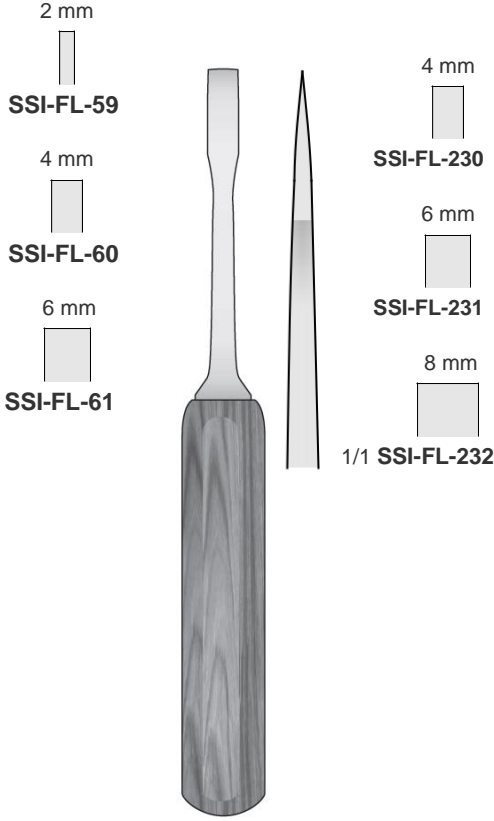
Email: sheffieldsurgicalinstruments@gmail.com
 Web: www.sheffieldsurgicalinst.com



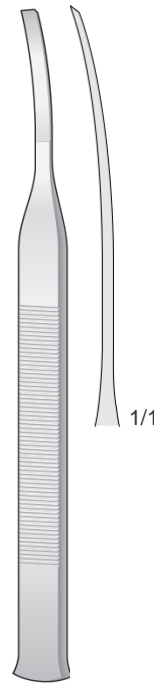
Osteotome - Meissel
 Osteotomes - Chisels
 Osteotomi - Scalpelli
 Osteótomos - Cinceles
 OSTEOTOMES - Burins



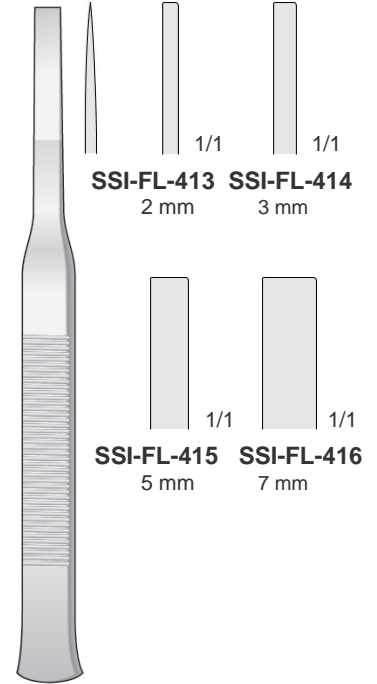
MINI-LEXER
 SSI-FL-59/SSI-FL-61
 200 mm



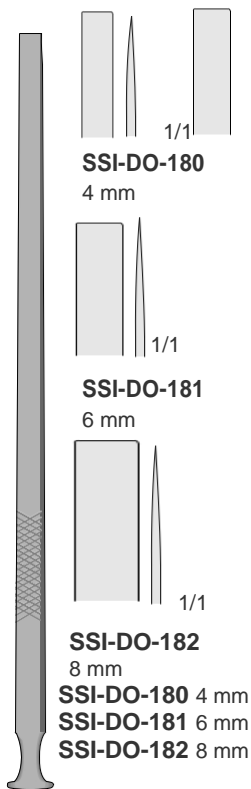
MINI-LEXER
 SSI-FL-230/SSI-FL-232
 180 mm



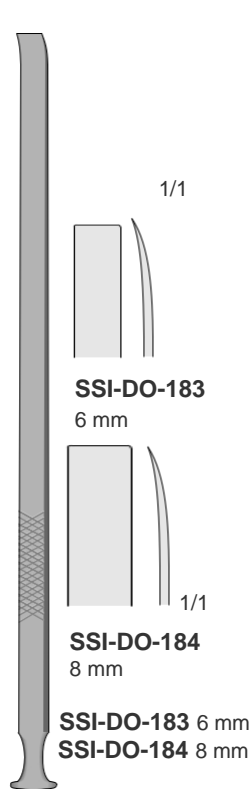
TESSIER
 SSI-FL-411 5 mm
 SSI-FL-412 7 mm
 160 mm



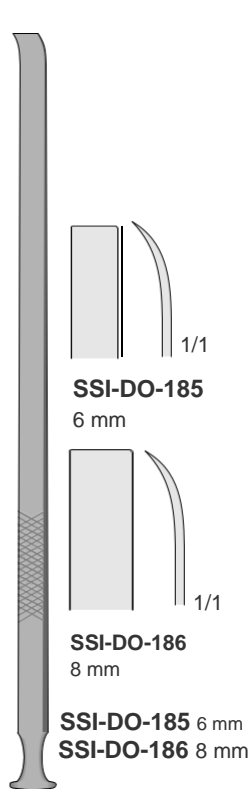
TESSIER
 SSI-FL-413/SSI-FL-416
 160 mm



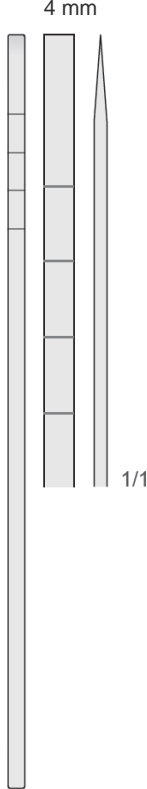
EPKER
 SSI-DO-180
 SSI-DO-182
 180 mm



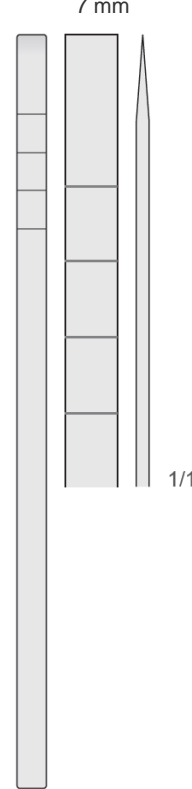
EPKER
 SSI-DO-183
 SSI-DO-184
 180 mm



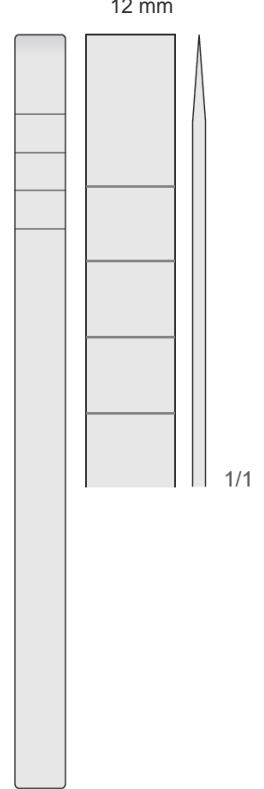
EPKER
 SSI-DO-185
 SSI-DO-186
 180 mm



COTTLE
 SSI-DO-140
 180 mm



COTTLE
 SSI-DO-141
 180 mm



COTTLE
 SSI-DO-143
 180 mm

Email: sheffieldsurgicalinstruments@gmail.com
 Web: www.sheffieldsurgicalinst.com

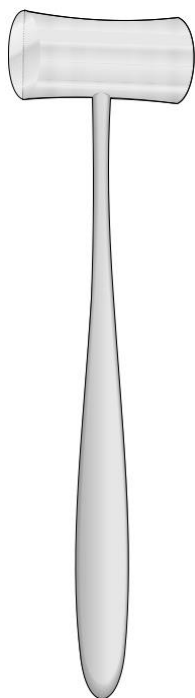
Chirurgische Hämmer
Surgical mallets
Martelli chirurgici
Martillos quirúrgicos
Maillets chirurgicaux

Ø 20 mm - 140 g



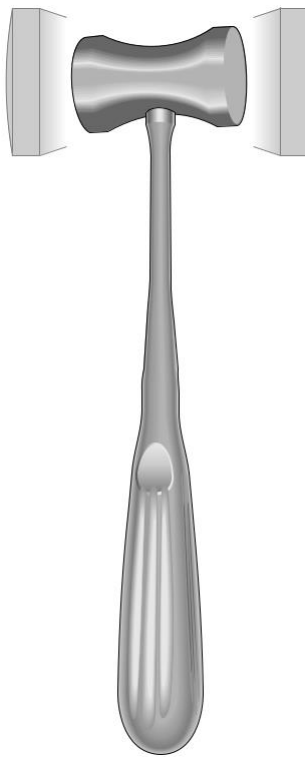
SSI-FL-01
165 mm

Ø 25 mm - 300 g



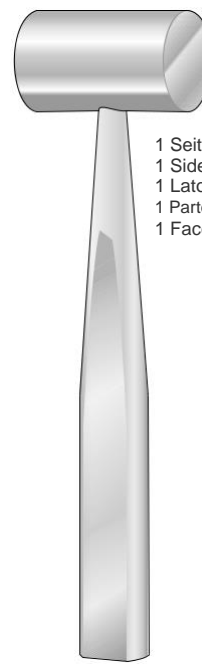
LUCAE
SSI-FL-10M
190 mm

Ø 27 mm - 135 g



HAJEK
SSI-FL-128
200 mm

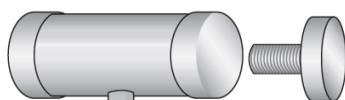
Ø 30 mm - 240 g



COTTLE
SSI-FL-10A
185 mm

1 Seite flach - 1 Seite convex
1 Side flat - 1 Side convex
1 Lato piatto - 1 Lato convesso
1 Parte plana - 1 Parte convexe
1 Face plate - 1 Face convexe

Ø 20 mm - 160 g



SSI-FL-09R

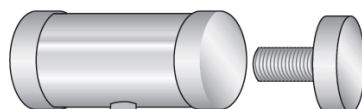
Paar Ersatzbacken
Pair of replacement
Paiodi ricambio
Par de recambio
Paire de rechange



MEAD
SSI-FL-09
190 mm

Mallet with interchangeable plastic disks
Hämmer mit auswechselbaren Kunststo backen
Maillet avec embouts de plastique interchangeables
Martillo con tapas plásticas reemplazables
Martello con punte de ricambi in te on

Ø 25 mm - 200 g



SSI-FL-11R

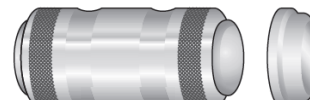
Paar Ersatzbacken
Pair of replacement
Paiodi ricambio
Par de recambio
Paire de rechange



MEAD
SSI-FL-11
200 mm

Mallet with interchangeable plastic disks
Hämmer mit auswechselbaren Kunststo backen
Maillet avec embouts de plastique interchangeables
Martillo con tapas plásticas reemplazables
Martello con punte de ricambi in te on

Ø 26 mm - 320 g



SSI-FL-12R

Paar Ersatzbacken
Pair of replacement
Paiodi ricambio
Par de recambio
Paire de rechange



MEAD
SSI-FL-12
190 mm



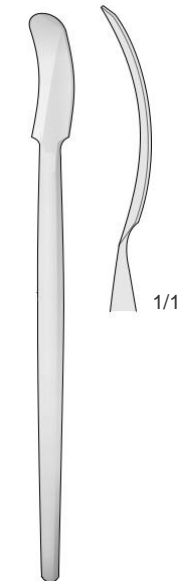
Sinus Lift Retraktoren - Sinus Lift Retractors
 Divaricatori per Sinus Lift - Separadores para Sinus Lift
 Écarteurs pour Sinus Lift

17 mm



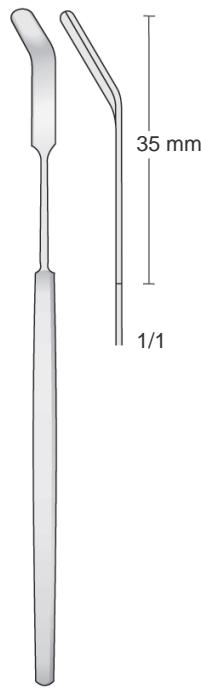
**SAUTTER
SSI-NK-249**
145 mm

11 mm



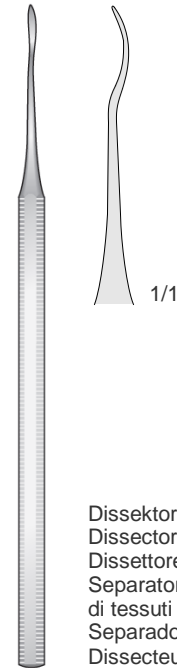
SSI-NK-105
125 mm

9 mm



**MODELL GIESSEN
SSI-NK-251**
160 mm

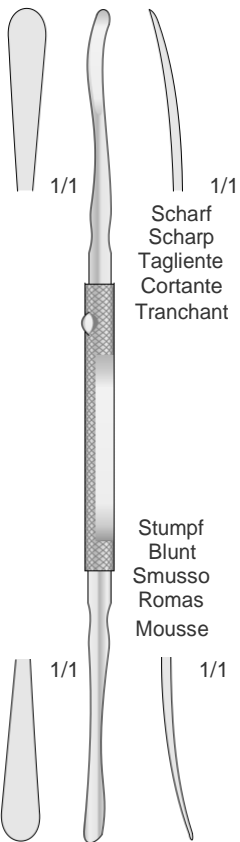
Raspatorien
 Periosteals
 Scollaperiosteai
 Periostótomos
 Rugines



SSI-ES-13
135 mm

Dissektor
 Dissector
 Dissetore
 Separatore
 di tessuti
 Separadores
 Dissecteur

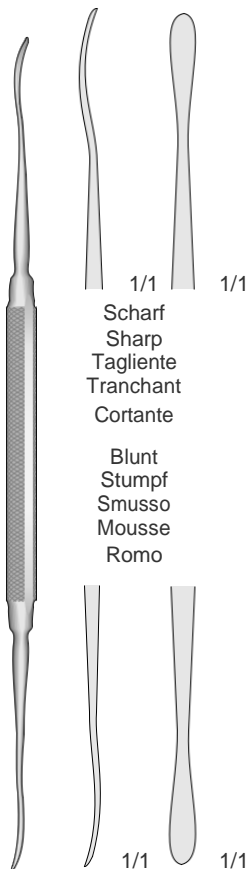
4.5 mm



**FREER
SSI-FR-16**
180 mm

Scharf
 Scharp
 Tagliente
 Cortante
 Tranchant

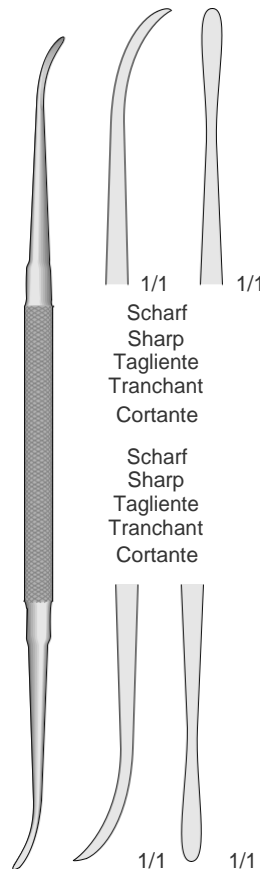
Stumpf
 Blunt
 Smusso
 Romas
 Mousse



**FREER
SSI-FR-17**
185 mm

Scharf
 Sharp
 Tagliente
 Tranchant
 Cortante

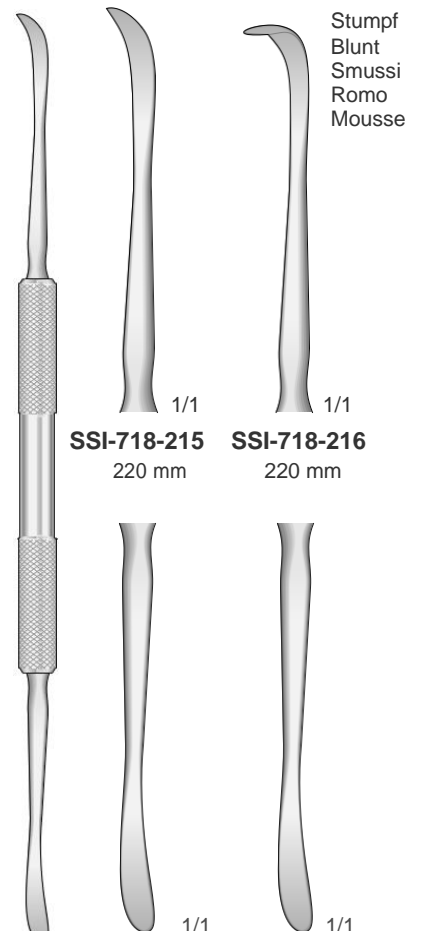
Blunt
 Stumpf
 Smusso
 Romo



**FREER-YASARGIL
SSI-FR-17**
185 mm

Scharf
 Sharp
 Tagliente
 Tranchant
 Cortante

Scharf
 Sharp
 Tagliente
 Tranchant
 Cortante



**OBWEGESER-FREER
SSI-718-215/SSI-718-216**
220 mm

Stumpf
 Blunt
 Smussi
 Romo
 Mousse

Email: sheffieldsurgicalinstruments@gmail.com
 Web: www.sheffieldsurgicalinst.com

Trepanbohrer
Trepines
Trepine
Trépanos
Trépan

Combination Trocar-Trephine Instruments

Bestehend aus einem Trokar, einer gezahnten Trepine und einem Kolben zur Entnahme von Knochentransplantaten aus Tibia und Beckenkamm mittels eines geschlossenen Verfahrens

Consisting of trocar, a toothed trephine and a plunger for taking tibial and iliac bone grafts through a closed technique

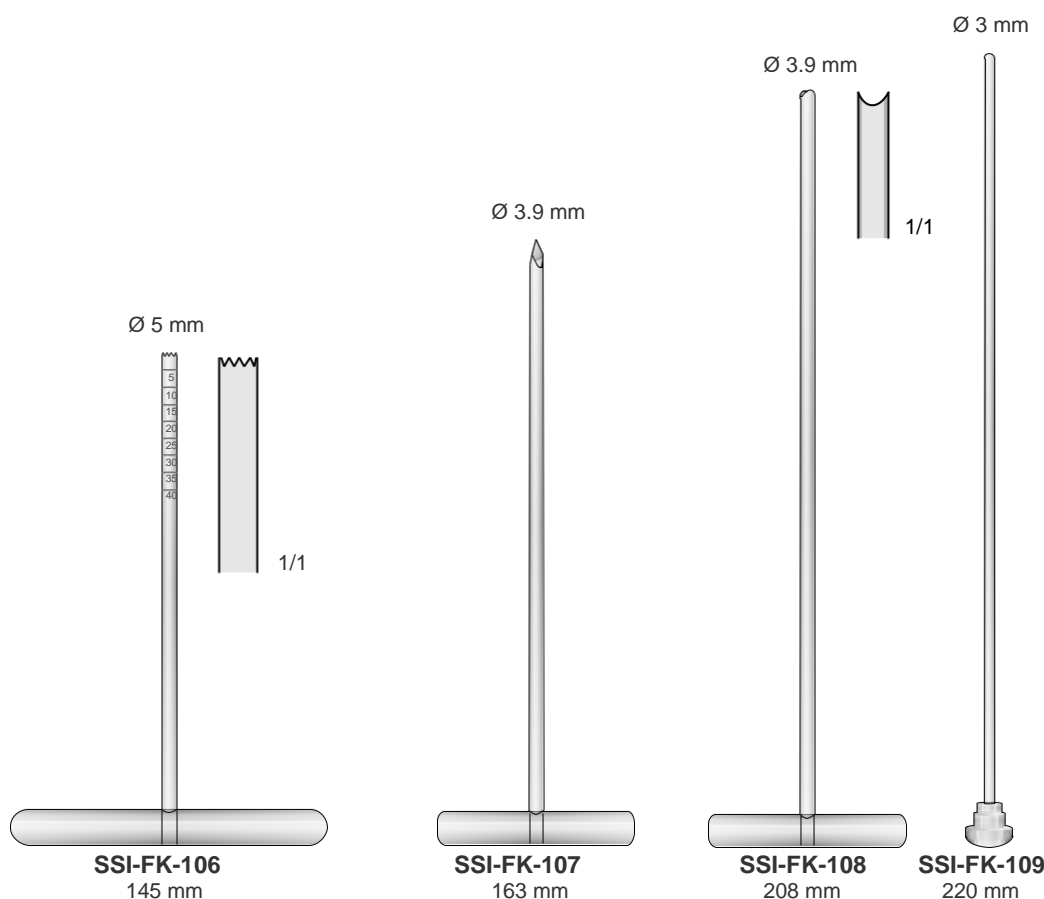
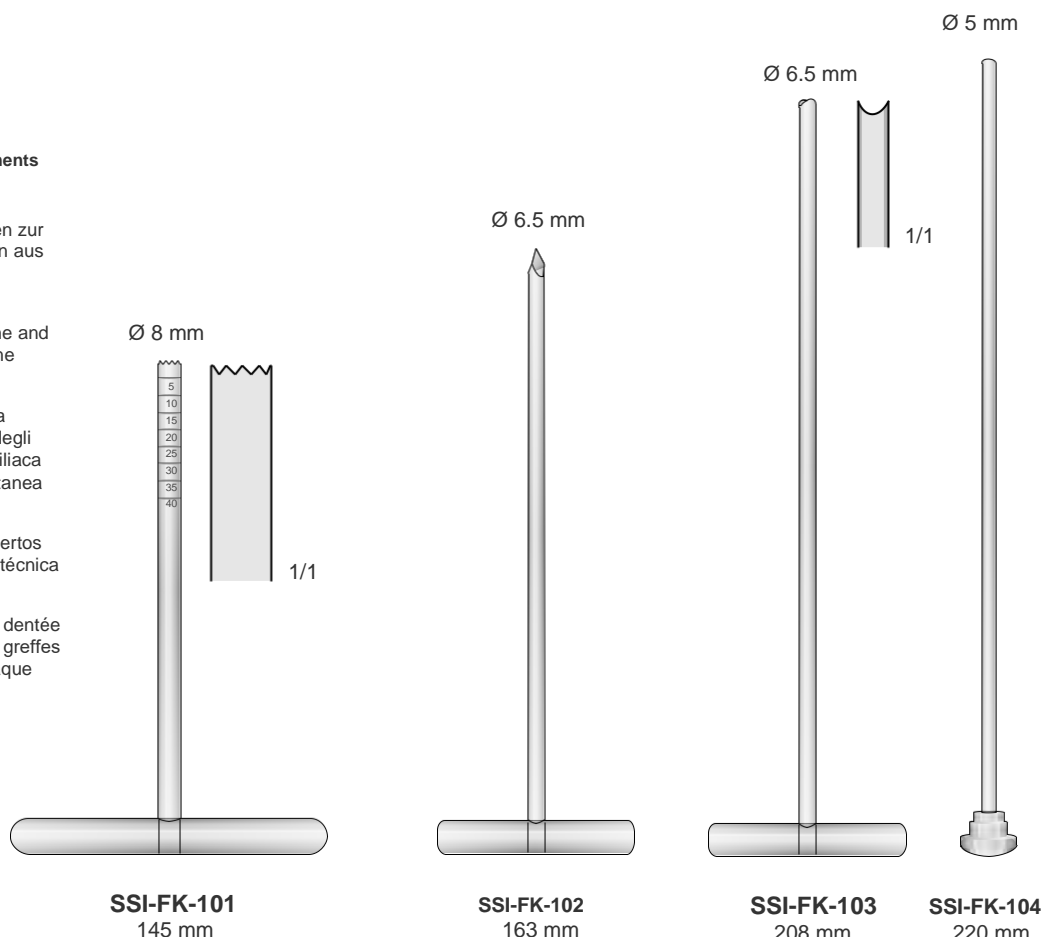
Composto di un trequarti, una camicia dentata ed un pistone per il prelievo degli innesti ossei dalla tibia e dalla cresta iliaca tramite una tecnica chirurgica intracutanea

Compuesto por un trócar, un trépano dentado y un émbolo para obtener injertos óseos tibiales e iliacos mediante una técnica cerrada

Composé d'un trocart, d'une tréphine dentée et d'un piston pour le prélèvement de greffes osseuses de la tibia ou de la crête iliaque par une technique fermée

SSI-FK-100

Komplettsset mit 4 Teilen
Set complete with 4 pieces
Set completo di 4 pezzi
Set completo con 4 piezas
Set complet avec 4 pièces

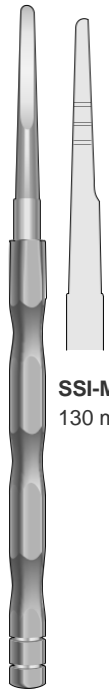


SSI-FK-105

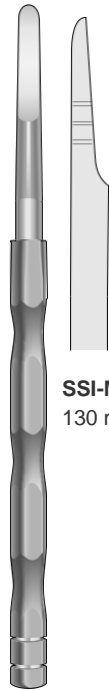
Komplettsset mit 4 Teilen
Set complete with 4 pieces
Set completo di 4 pezzi
Set completo con 4 piezas
Set complet avec 4 pièces



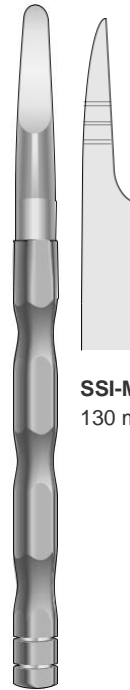
Implantologie Instrumente
Implantology Instruments
Strumenti per implantologia
Instrumentos para Implantología
Instruments pour Implantologie



SSI-MIR-30
130 mm



SSI-MIR-31
130 mm



SSI-MIR-32
130 mm



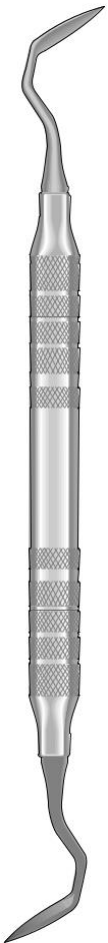
SSI-MIR-33
130 mm

BONE EXPANDERS

Distraktoren für Knochenleiste
Distracteurs de crête osseuse
Expansores de cresta ósea
Distrattori per cresta ossea

TUNNELING INSTRUMENTS

Tunnelierinstrumente | Instruments pour tunnellation | Instrumentos para tunelización | Strumenti per tunneling



SSI-UST-1/2ML



SSI-UST-1/2MS



SSI-UST-KPA



USSI-SS-YG7/8



SSI-UST-MP



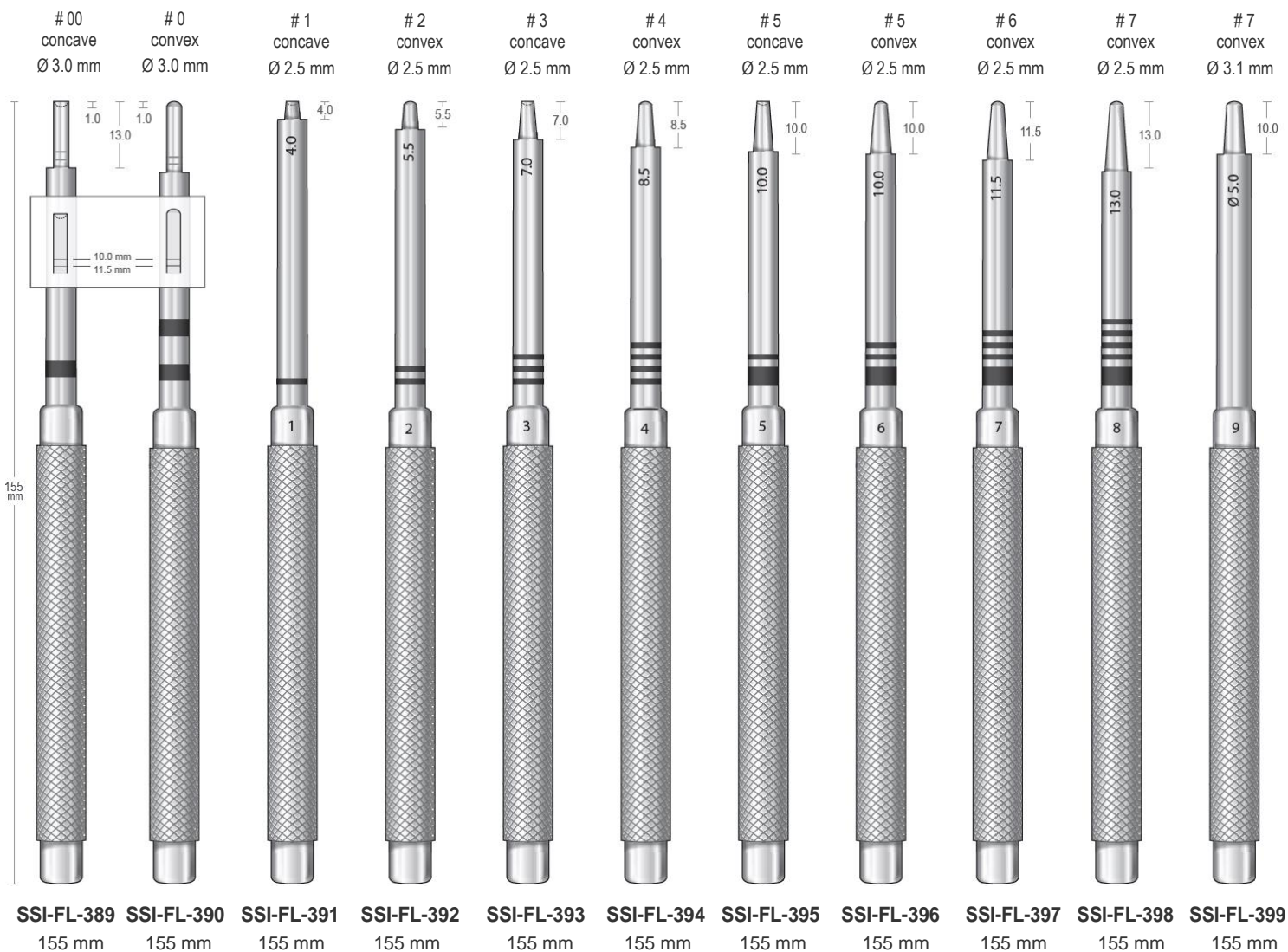
SSI-UST-MPA

Email: sheffieldsurgicalinstruments@gmail.com
Web: www.sheffieldsurgicalinst.com

Osteotome
Osteotomes
Osteotomi
Osteótomos
Ostéotomes

SSI-FL-400
IMPLANT SINUS LIFT OSTEOTOMES SET
SSI-FL-391 + SSI-FL-392 + SSI-FL-393 + SSI-FL-394
+ SSI-FL-395 + SSI-FL-396 + SSI-FL-397 + SSI-FL-398 + SSI-FL-399
(1+2+3+4+5+6+7+8+9)
+ SSI-BS-60 (Stainless Steel Container)

SSI-FL-400M
COMPLETE IMPLANT SINUS LIFT OSTEOTOMES SET
SSI-FL-389 + SSI-FL-390 + SSI-FL-391 + SSI-FL-392 + SSI-FL-393
+ SSI-FL-394 + SSI-FL-395 + SSI-FL-396 + SSI-FL-397 + SSI-FL-398 + SSI-FL-399
(00+0+1+2+3+4+5+6+7+8+9)
+ SSI-BS-60 (Stainless Steel Container)



Email: sheffieldsurgicalinstruments@gmail.com
Web: www.sheffieldsurgicalinst.com



Osteotome
Osteotomes
Osteotomi
Osteótomos
Ostéotomes

| # 1 | Diam. | # 2 | Diam. | # 3 | Diam. | # 4 | Diam. | # 5 | Diam. | # 6 | Diam. |
|------|--------|------|--------|------|--------|------|--------|------|--------|-----|--------|
| 0 | Ø 1.60 | 0 | Ø 1.90 | 0 | Ø 2.80 | 0 | Ø 3.10 | 0 | Ø 3.90 | 0 | Ø 5.50 |
| 7.5 | Ø 1.80 | 7.5 | Ø 2.20 | 7.5 | Ø 3.20 | 7.5 | Ø 3.70 | 10 | Ø 5.00 | 10 | Ø 6.20 |
| 10 | Ø 2.00 | 10 | Ø 2.35 | 10.5 | Ø 3.35 | 10.5 | Ø 3.90 | 13 | Ø 5.20 | 13 | Ø 6.30 |
| 13.5 | Ø 2.40 | 13.5 | Ø 3.30 | 13.5 | Ø 3.60 | 15.5 | Ø 4.30 | 20.5 | Ø 6.30 | | |
| 15.5 | Ø 3.60 | 15.5 | Ø 3.40 | 21 | Ø 4.40 | | | | | | |
| | | 23.5 | Ø 4.50 | | | | | | | | |

1 # 2 # 3 # 4 # 5 # 6
 Ø 1.6 mm Ø 1.9 mm Ø 2.8 mm Ø 3.10 mm Ø 3.90 mm Ø 5.50 mm



SSI-FL-120
155 mm



SSI-FL-121
155 mm



SSI-FL-122
155 mm



SSI-FL-123
155 mm



SSI-FL-124
155 mm



SSI-FL-125
155 mm

Email: sheffieldsurgicalinstruments@gmail.com
 Web: www.sheffieldsurgicalinst.com

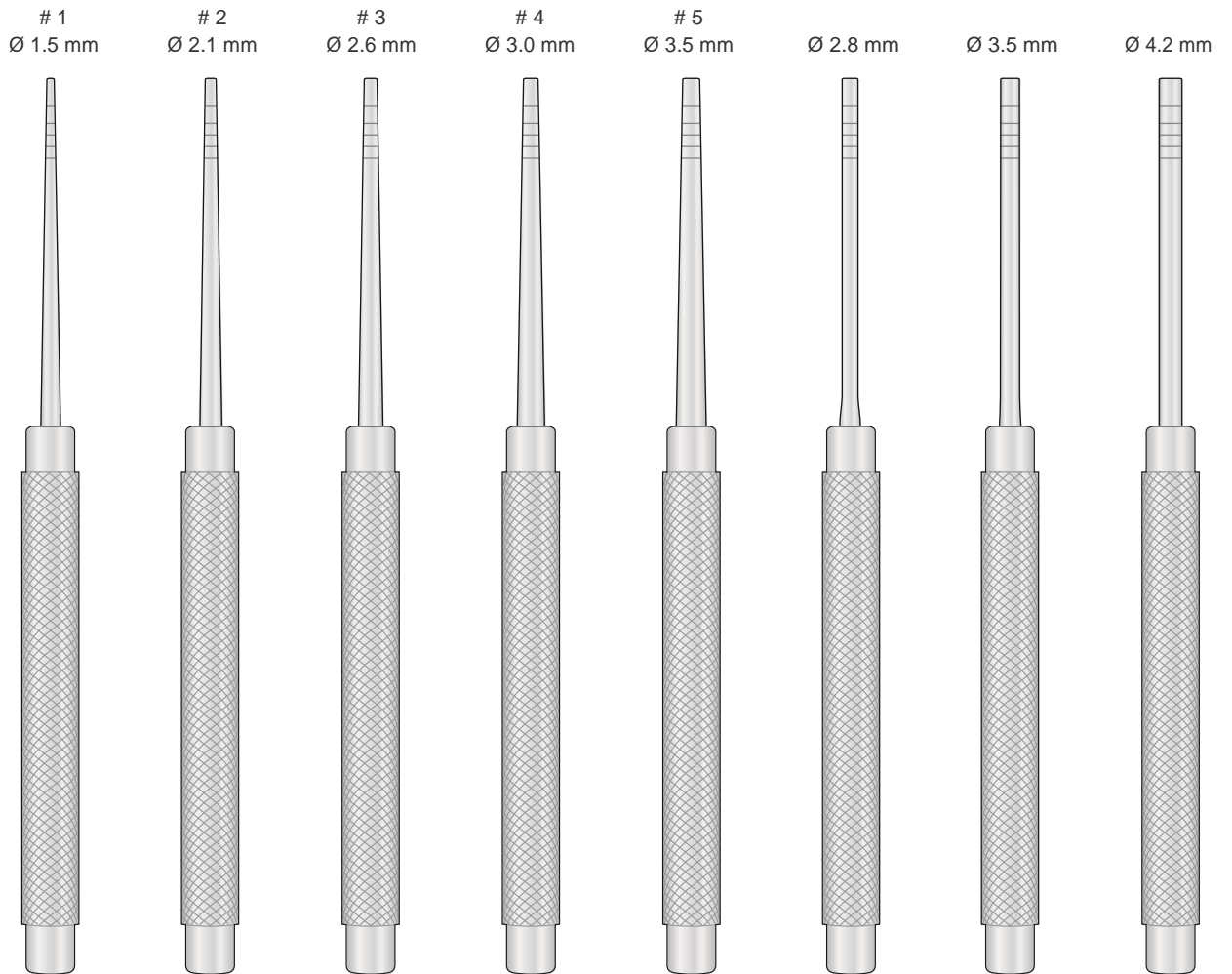


Osteotome
 Osteotomes
 Osteotomi
 Osteótomos
 Ostéotomes

| # 1 | Diam. | # 2 | Diam. | # 3 | Diam. | # 4 | Diam. | # 5 | Diam. |
|-----|--------|-----|--------|-----|--------|-----|--------|-----|--------|
| 0 | Ø 1.50 | 0 | Ø 2.10 | 0 | Ø 2.60 | 0 | Ø 3.00 | 0 | Ø 3.50 |
| 5 | Ø 1.90 | 5 | Ø 2.60 | 5 | Ø 3.00 | 5 | Ø 3.50 | 5 | Ø 3.90 |
| 8 | Ø 2.20 | 8 | Ø 2.80 | 8 | Ø 3.30 | 8 | Ø 3.80 | 8 | Ø 4.20 |
| 10 | Ø 2.40 | 10 | Ø 3.00 | 10 | Ø 3.50 | 10 | Ø 4.00 | 10 | Ø 4.40 |
| 12 | Ø 2.60 | 12 | Ø 3.20 | 12 | Ø 3.70 | 12 | Ø 4.20 | 12 | Ø 4.60 |
| 14 | Ø 2.80 | 14 | Ø 3.40 | 14 | Ø 3.90 | 14 | Ø 4.40 | 14 | Ø 4.80 |

Straight
 Gerade
 Droit
 Recto
 Diritto

Bone Pusher



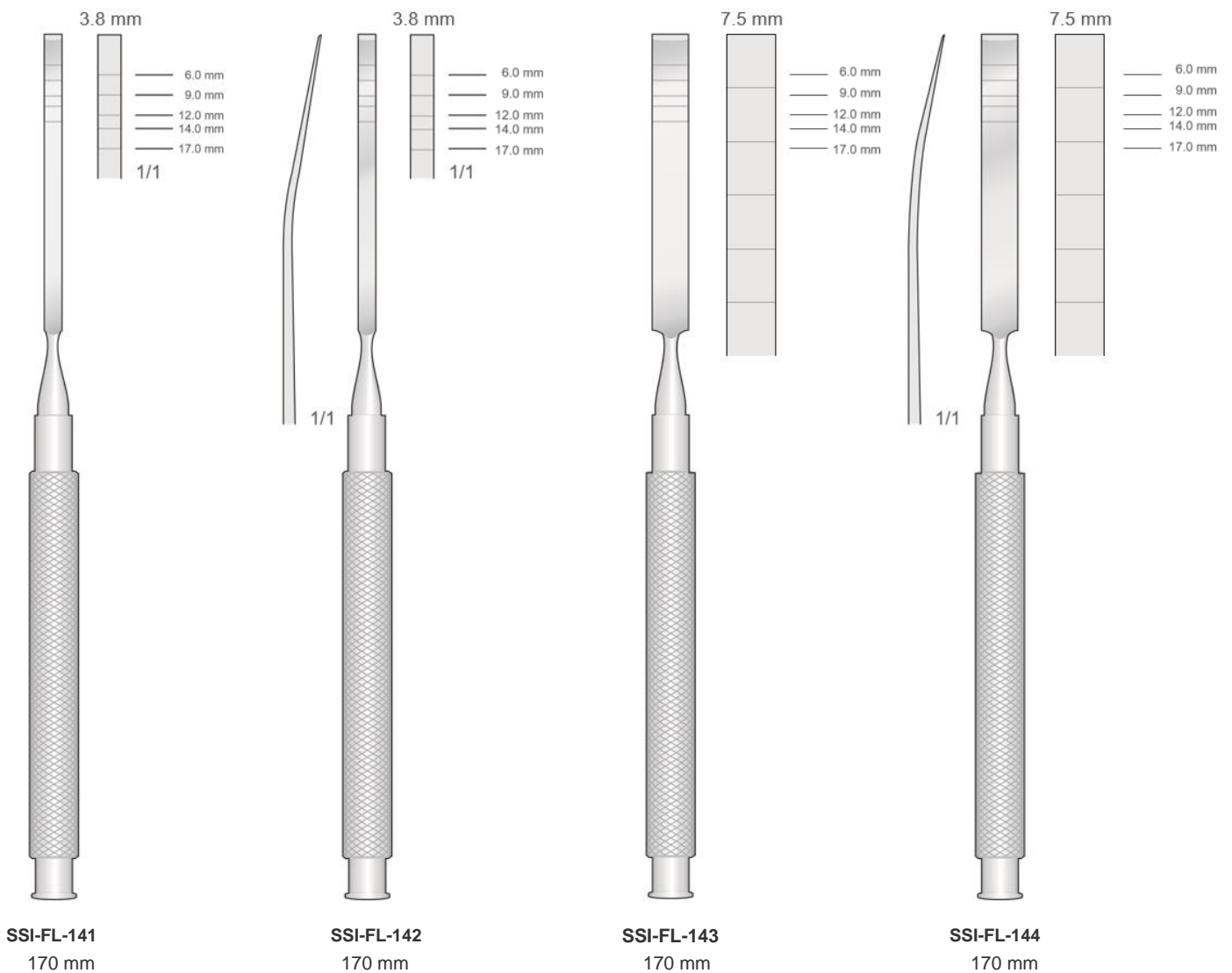
| | | | | | | | |
|----------------------------|-----------------------------|-----------------------------|-----------------------------|-----------------------------|-----------------------------|-----------------------------|-----------------------------|
| SSI-FL-292 55 mm | SSI-FL-293 155 mm | SSI-FL-294 155 mm | SSI-FL-295 155 mm | SSI-FL-296 155 mm | SSI-FL-297 155 mm | SSI-FL-298 155 mm | SSI-FL-299 155 mm |
|----------------------------|-----------------------------|-----------------------------|-----------------------------|-----------------------------|-----------------------------|-----------------------------|-----------------------------|

Email: sheffieldsurgicalinstruments@gmail.com
 Web: www.sheffieldsurgicalinst.com



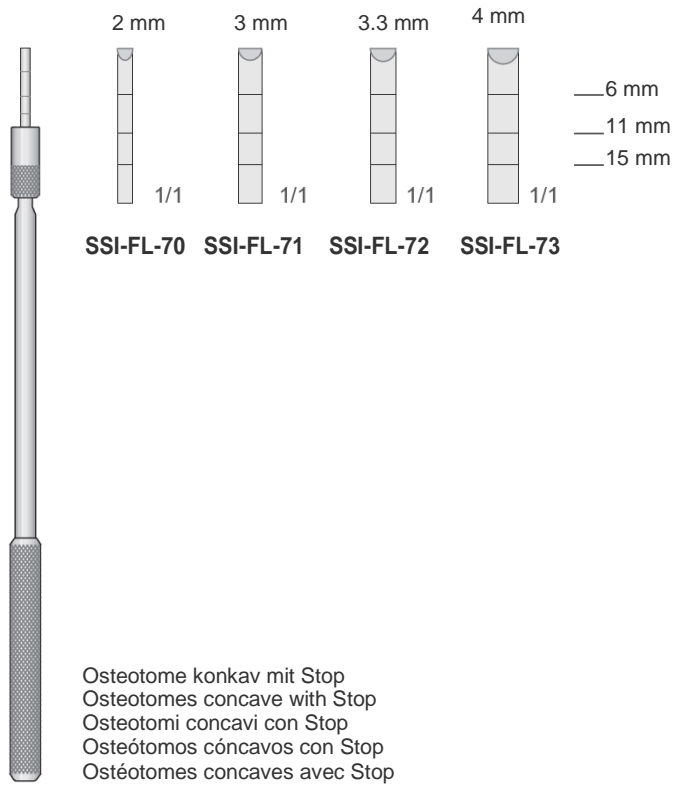
Osteotome
Osteotomes
Osteotomi
Osteótomos
Ostéotomes

Meißeln Graduiert
Graduated Chisels
Scalpelli graduati
Cinceles graduados
Burins gradués

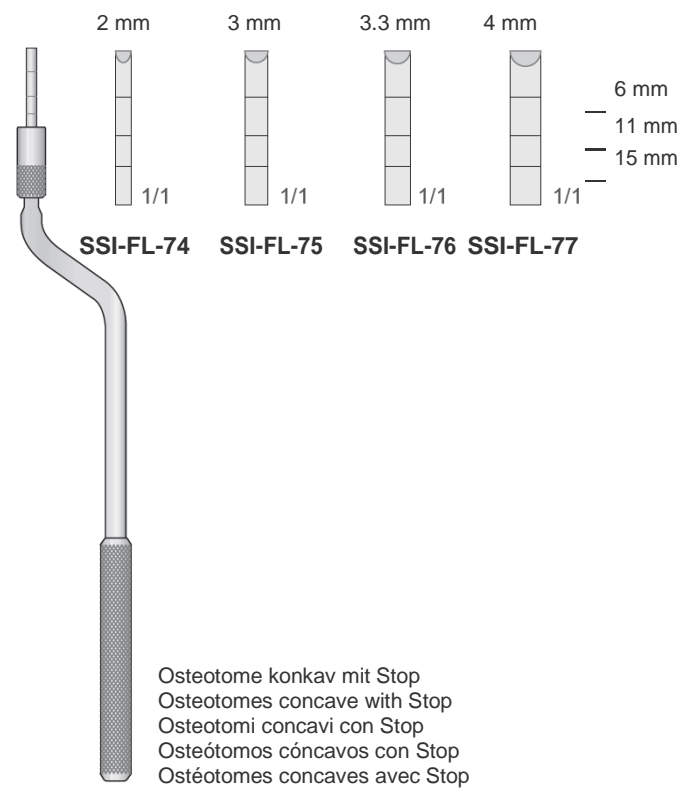


Email: sheffieldsurgicalinstruments@gmail.com
Web: www.sheffieldsurgicalinst.com

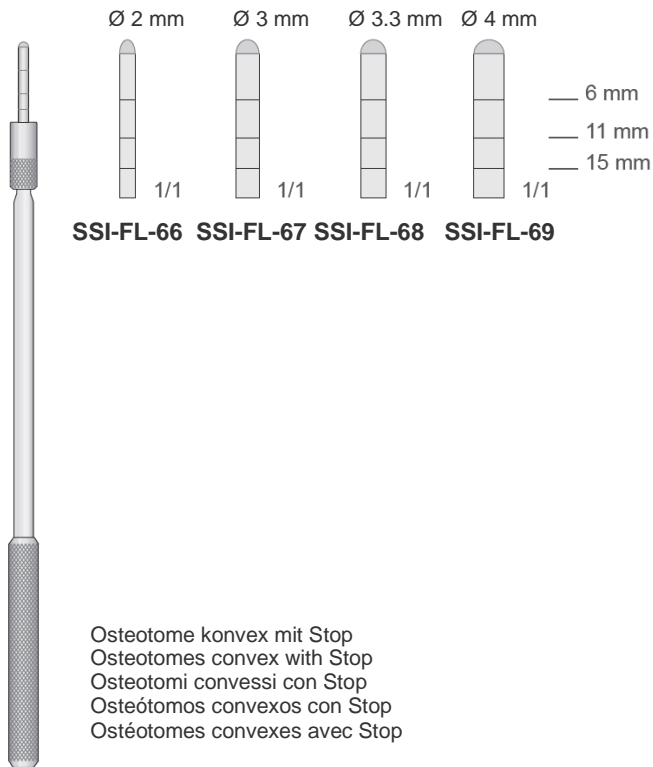
Osteotome
 Osteotomes
 Osteotomi
 Osteótomos
 Ostéotomes



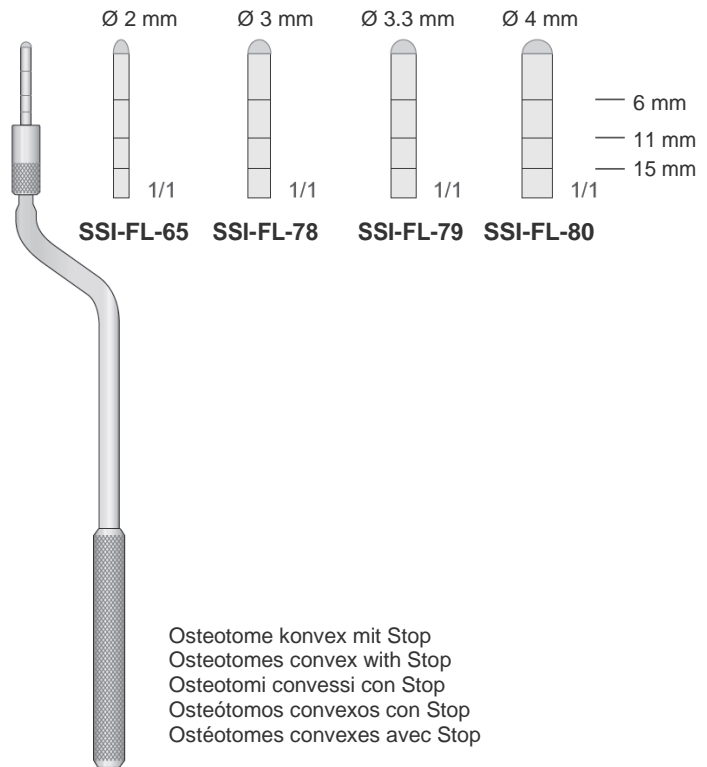
SSI-FL-70/SSI-FL-73
 165 mm



SSI-FL-74/SSI-FL-77
 165 mm



SSI-FL-66/SSI-FL-69
 165 mm

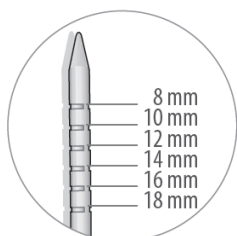


SSI-FL-65/SSI-FL-80
 160 mm

Email: sheffieldsurgicalinstruments@gmail.com
 Web: www.sheffieldsurgicalinst.com

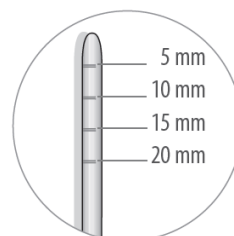


Osteotome
Osteotomes
Osteotomi
Osteótomos
Ostéotomes



Dilatator
Dilator
Dilatatori
Dilatador
Dilatateur

A-Form



Spreader
Spreader
Expansori
Expansor
Expandeur

**D-Form
Convex Tip**

Ø 2 mm

Ø 3 mm

Ø 3.3 mm

Ø 4 mm

Ø 3 mm

Ø 4 mm

Ø 5 mm



SSI-FL-25
145 mm

SSI-FL-26
145 mm

SSI-FL-27
145 mm

SSI-FL-28
145 mm

SSI-FL-37
145 mm

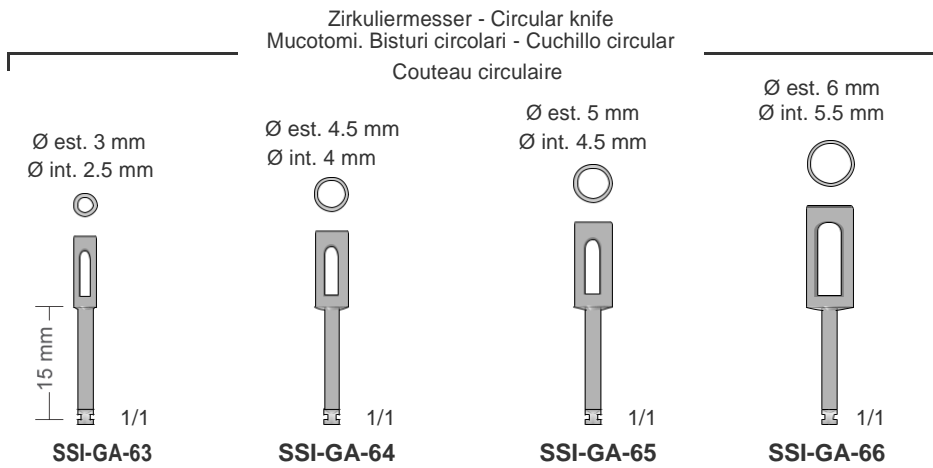
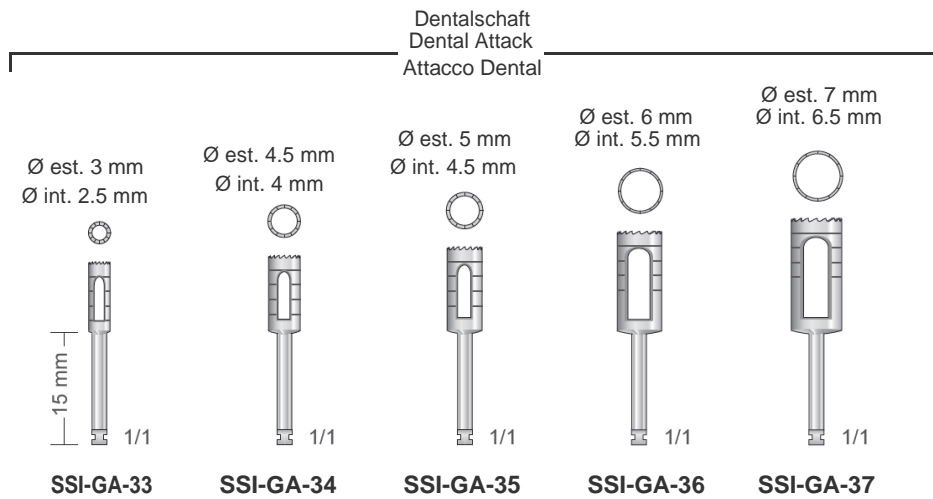
SSI-FL-38
145 mm

SSI-FL-39
145 mm

Email: sheffieldsurgicalinstruments@gmail.com
Web: www.sheffieldsurgicalinst.com

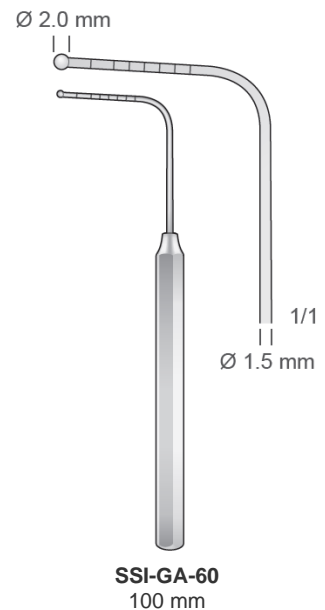
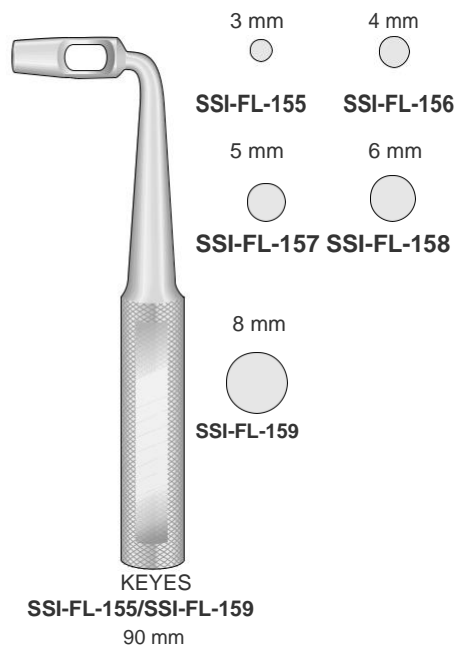
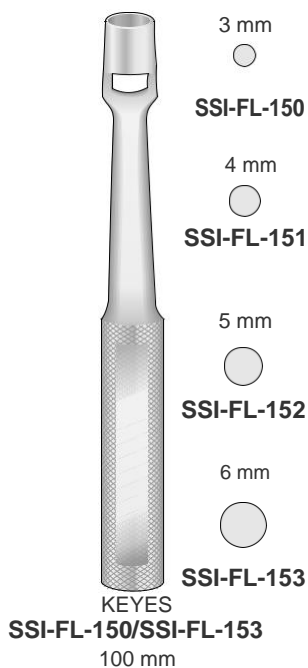


Trepanbohrer
Trepines
Trepine
Trépanos
Trépanos



Hautstanzen - Tissue punches
Mucotomi Punches - Instrumentos para cortar tejidos
Instruments à couper le tissu

Implant Graduierung
Implant depth gauge with ball end
Sonda per controllare la profondità del sito
Sonda para controlar la profundidad



Email: sheffieldsurgicalinstruments@gmail.com
Web: www.sheffieldsurgicalinst.com



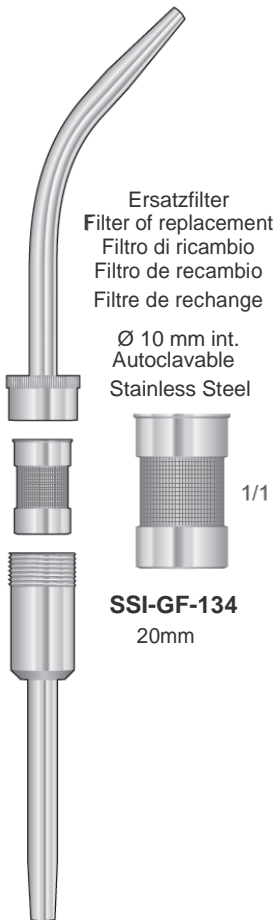
Knochenschale
 Bone Well
 Bacinella per osso
 Cubeta para hueso
 Cuvette à os



Rostfrei
 Stainless Steel
 Acciaio inossidabile
 Acero inoxidable
 Acier Inoxydable

SSI-SS-65
 35 mm

Absaugkanülen für Knochen. mit Filter
 Suction tube for bone. with filter
 Cannule d'aspiration con trattenuta osso. con filtro
 Cánulas aspiradoras para hueso. con filtro
 Canule d'aspiration pour os avec filtre



Ersatzfilter
 Filter of replacement
 Filtro di ricambio
 Filtro de recambio
 Filtre de rechange

Ø 10 mm int.
 Autoclavable
 Stainless Steel

1/1

SSI-GF-134
 20mm

SSI-GF-133
 180 mm

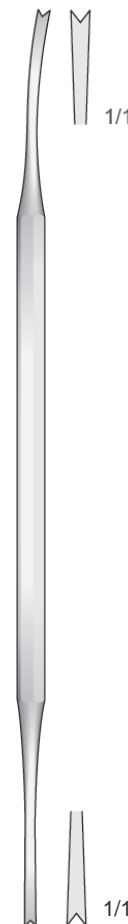
Membranplatzierungsinstrumente
 Membrane Placement Instruments
 Strumenti per posizionare membrana
 Instrumentos para colocar membranas
 Instruments pour application de membrane



2/1

1/1

SSI-MPI-1
 185 mm



1/1

1/1

LUNIATSCHEK
SSI-PF-6
 170 mm

Aufbring Instrument für Knochenmaterial
 Applicator for bone material
 Applicatore per materiale osseo
 Cucharillas para material osseo
 Applicateur pour matière osseuse



1/1

1/1

SSI-IM-15
 180 mm

Knochenmühlen - und spritzen
 Bone Mills and Syringes
 Macina e siringhe per osso
 Molinos y jeringas para hueso
 Moulinis et seringues à os



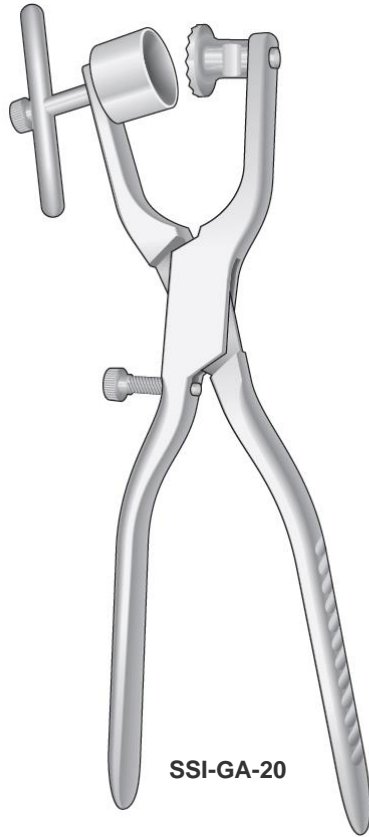
SSI-GA-18
 Lower
 Titanium



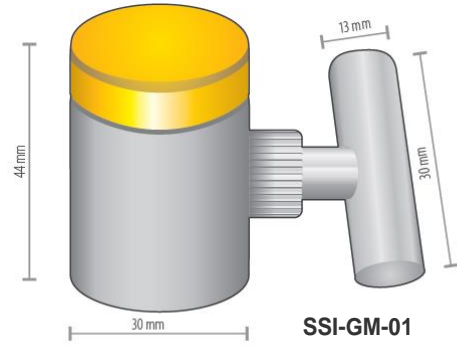
SSI-GA-17
 Upper
 Titanium



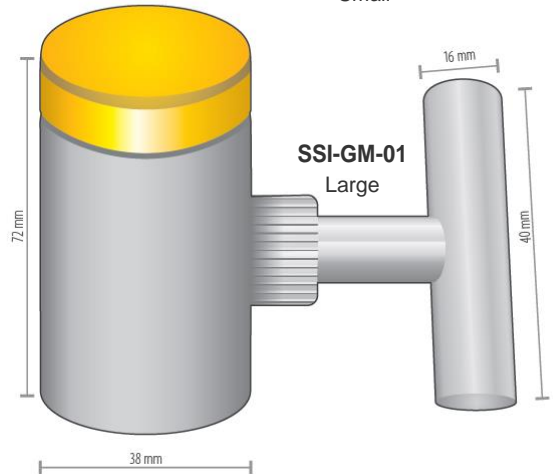
SSI-GA-19
 Handle
 with screw



SSI-GA-20

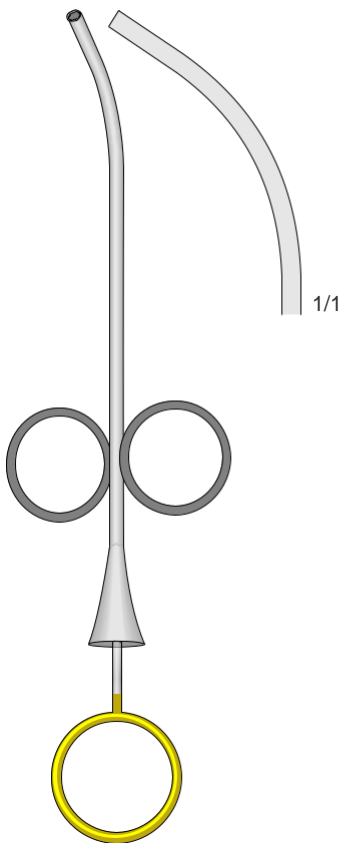


SSI-GM-01
 Small



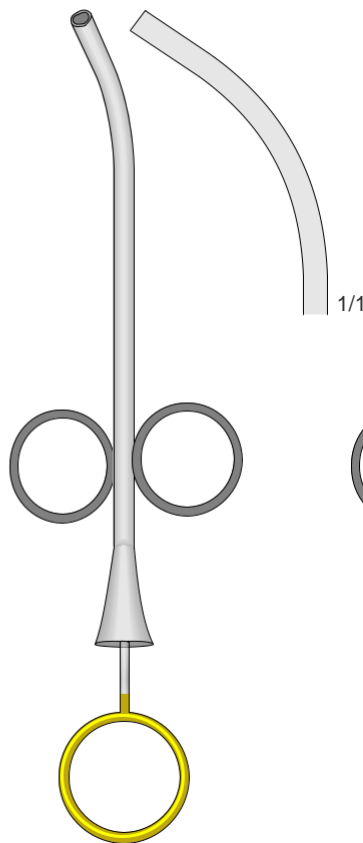
SSI-GM-01
 Large

Ø Int. 2.5 mm
 Ø Est. 3.5 mm



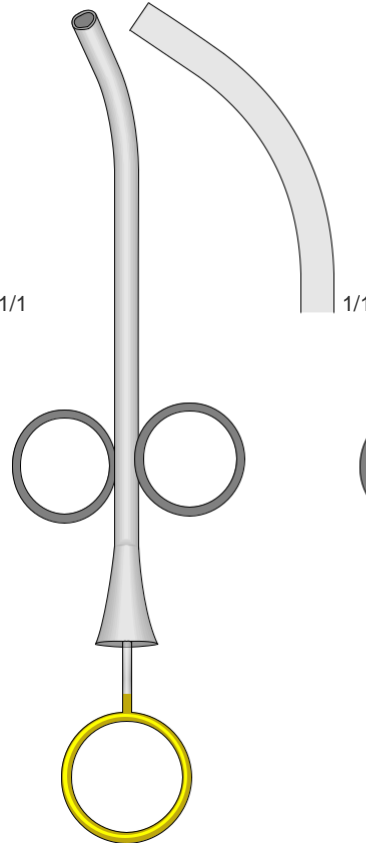
SSI-SS-60M
 160 mm

Ø Int. 3.5 mm
 Ø Est. 4.5 mm



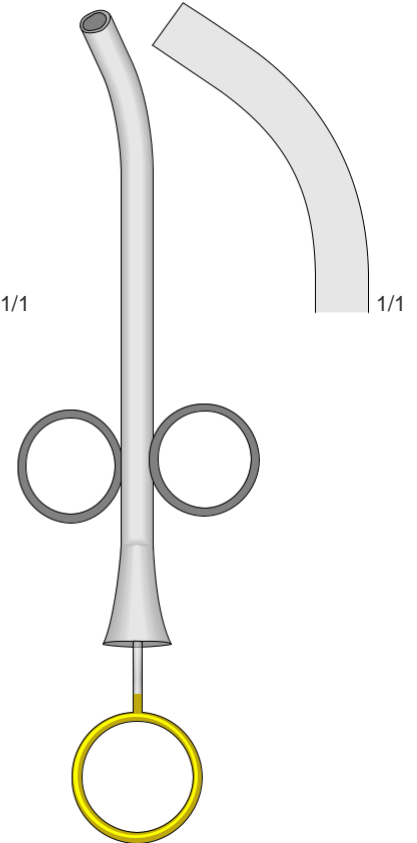
SSI-SS-61M
 160 mm

Ø Int. 4.4 mm
 Ø Est. 5.5 mm



SSI-SS-62M
 160 mm

Ø Int. 6 mm
 Ø Est. 7 mm



SSI-SS-64M
 160 mm

Email: sheffieldsurgicalinstruments@gmail.com
 Web: www.sheffieldsurgicalinst.com



Knochenstopfer
 Bone Tampers - Bone Grafting Packers
 Compattatore per osso
 Compactador para hueso
 Compacteur à os



| | Non Serrated Tips | | | | Serrated Tips | | | |
|-------------------|-------------------|-------|---|-------|---------------|-------|---|-------|
| SSI-USB-P1 | ○ | Ø 1.8 | ○ | Ø 2.8 | ● | Ø 1.8 | ● | Ø 2.8 |
| SSI-USB-P2 | ○ | Ø 3.2 | ○ | Ø 3.8 | ● | Ø 3.2 | ● | Ø 3.8 |
| SSI-USB-P3 | ○ | Ø 4.2 | ○ | Ø 4.8 | ● | Ø 4.2 | ● | Ø 4.8 |
| SSI-USB-P4 | ○ | Ø 5.0 | ○ | Ø 5.5 | ● | Ø 5.0 | ● | Ø 5.5 |

Ø 3 mm

Ø 5 mm

Ø 4 mm

Ø 3 mm

Ø 5 mm

3 mm

6 mm

Misura interna

- **SSI-SS-20** Ø 3 mm
- **SSI-SS-21** Ø 4 mm
- **SSI-SS-22** Ø 5 mm

SSI-FL-20
155 mm

SSI-FL-21
155 mm

SSI-FL-31
155 mm

SSI-FL-33
155 mm

SSI-FL-35
155 mm

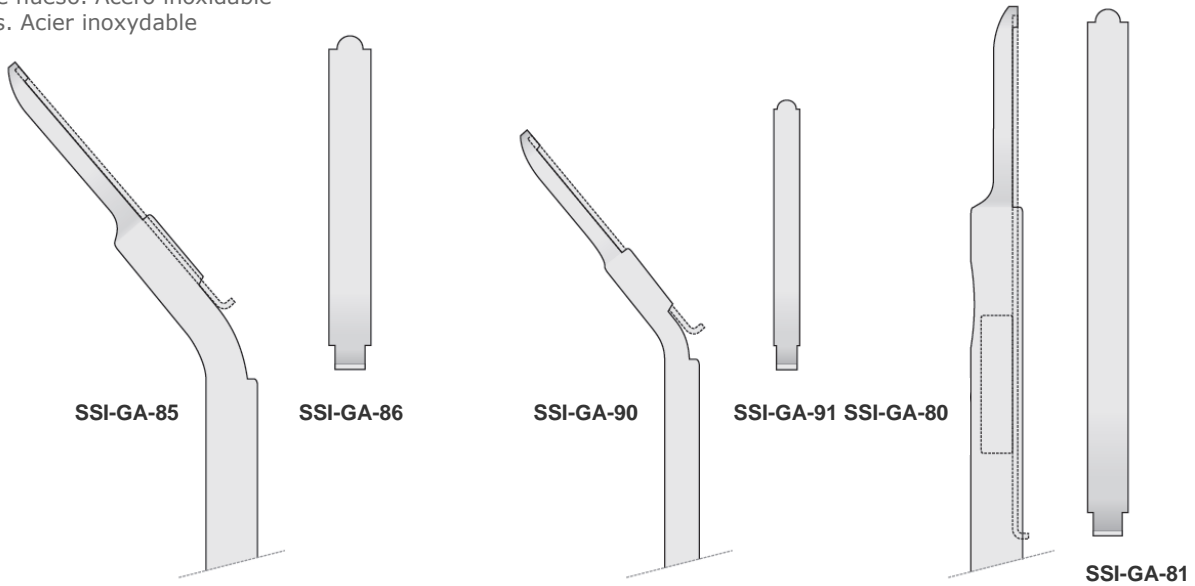
SSI-OSSI-P-7
170 mm

SSI-OSSI-P-8
170 mm

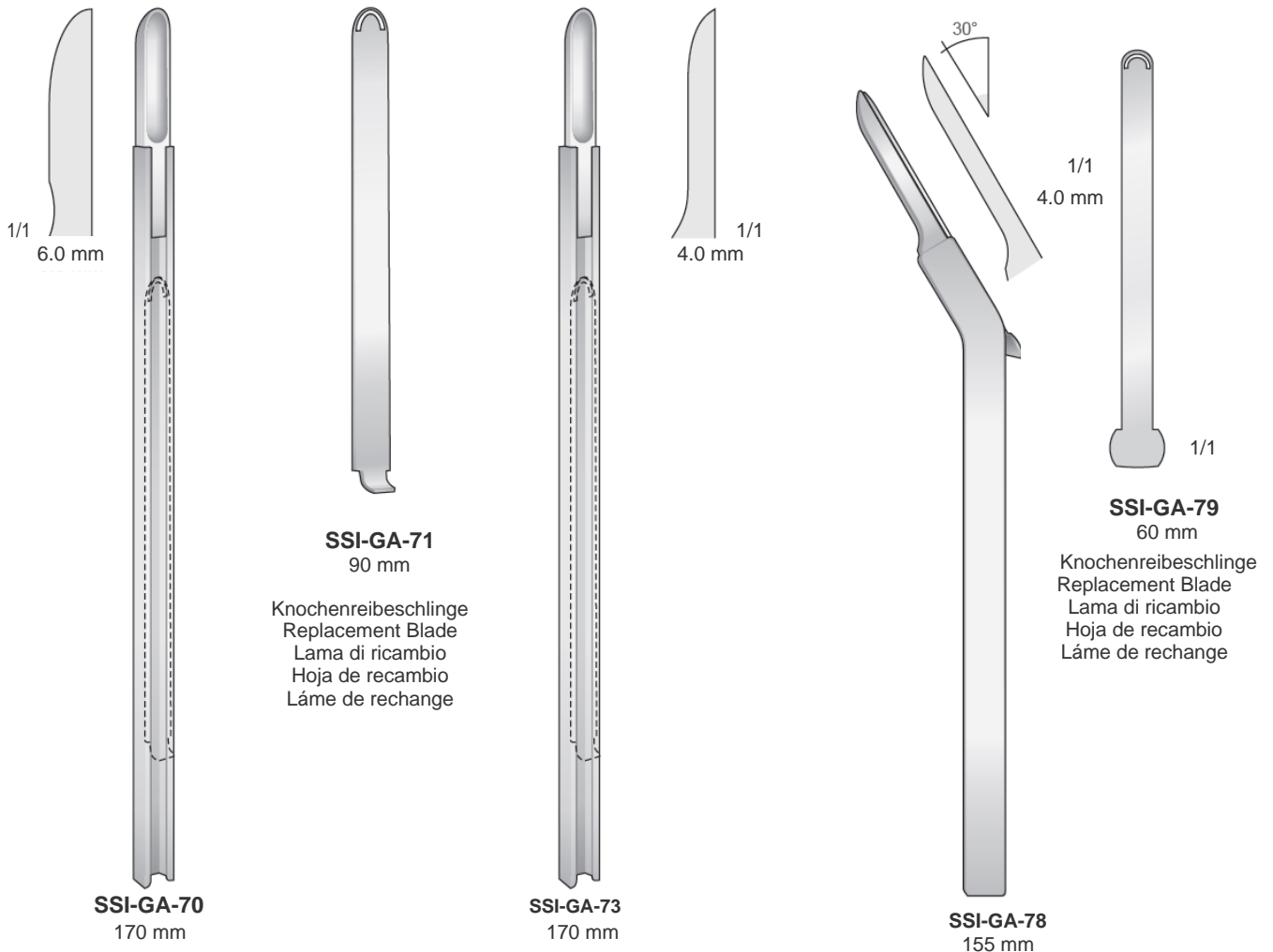
FOITZIK
SSI-SS-20/SSI-SS-22
140 mm

Email: sheffieldsurgicalinstruments@gmail.com
 Web: www.sheffieldsurgicalinst.com

Knochenschaber. Rostfrei Stahl
 Bone-Grafter. Stainless Steel
 Grattini per osso. Inox
 Raspador de hueso. Acero inoxidable
 Racleur d'os. Acier inoxydable



Knochenschaber mit Reibeklinge
 Bone-Grafter with blade
 Grattino con lama
 Raspador de hueso con hoja
 Racleur d'os avec lame



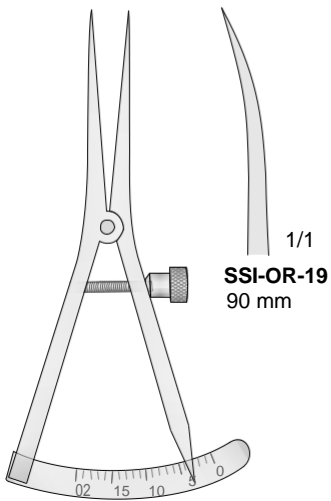
30°

Email: sheffieldsurgicalinstruments@gmail.com
 Web: www.sheffieldsurgicalinst.com



Messinstrumente
Measuring instruments
Strumenti per misura
Instrumentos para medir
Instruments à mesurer

Meßbereich: 0 - 20 mm
Measuring range: 0 - 20 mm
Campo di misura: 0 - 20 mm
Alcance de medición: 0 - 20 mm
Etendue de mesure: 0 - 20 mm



SSI-OR-19
CASTROVIEJO
90 mm



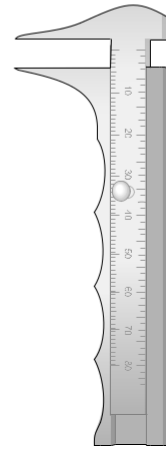
SSI-LS-08
100 mm



SSI-LS-09
200 mm



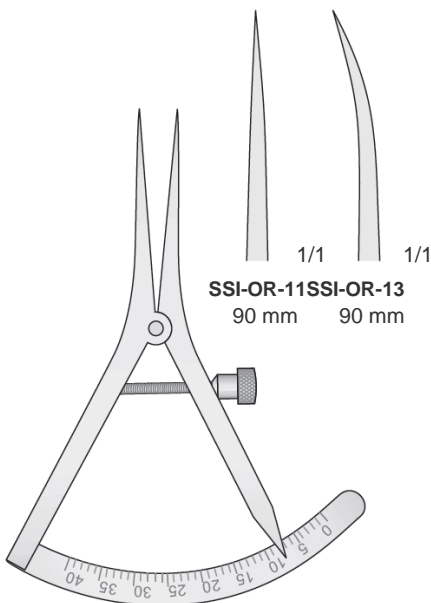
SSI-OR-40
125 mm



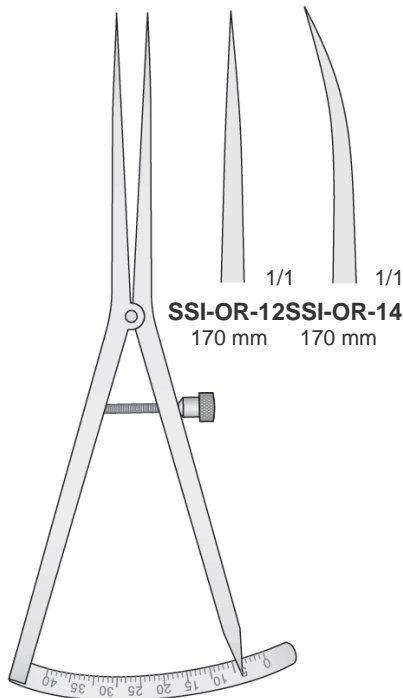
SSI-OR-45
95 mm

Meßbereich: 0 - 80 mm
Measuring range: 0 - 80 mm
Campo di misura: 0 - 80 mm
Alcance de medición: 0 - 80 mm
Etendue de mesure: 0 - 80 mm

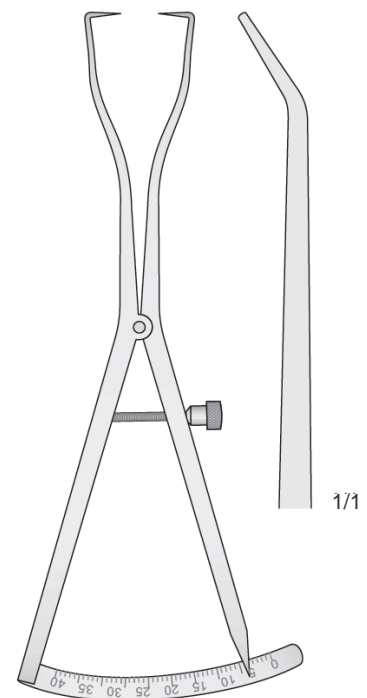
0 - 40 mm
Meßbereich / Measuring range / Campo di misura
Alcance de medición / Etendue de mesure



CASTROVIEJO
SSI-OR-11/SSI-OR-13
90 mm



CASTROVIEJO
SSI-OR-12/SSI-OR-14
170 mm

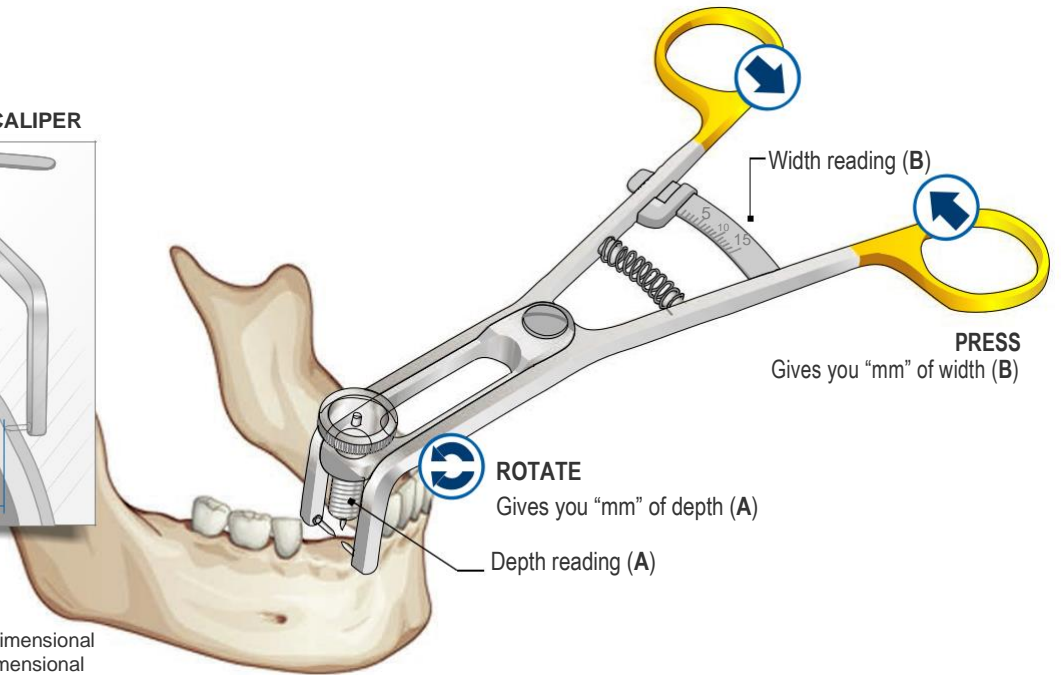
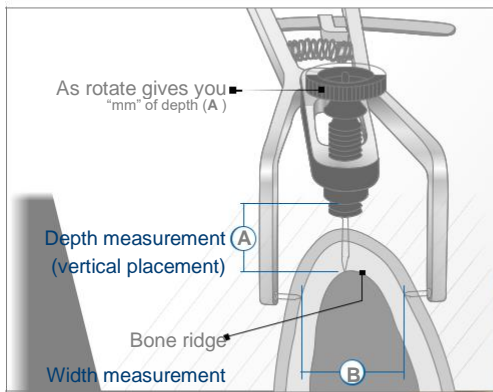


CASTROVIEJO
SSI-OR-18
170 mm

Email: sheffieldsurgicalinstruments@gmail.com
Web: www.sheffieldsurgicalinst.com

Osteometer
 Osteometer
 Osteometro
 Osteometro
 Osteometer

TRIDIMENSIONAL IMPLANTOLOGY CALIPER

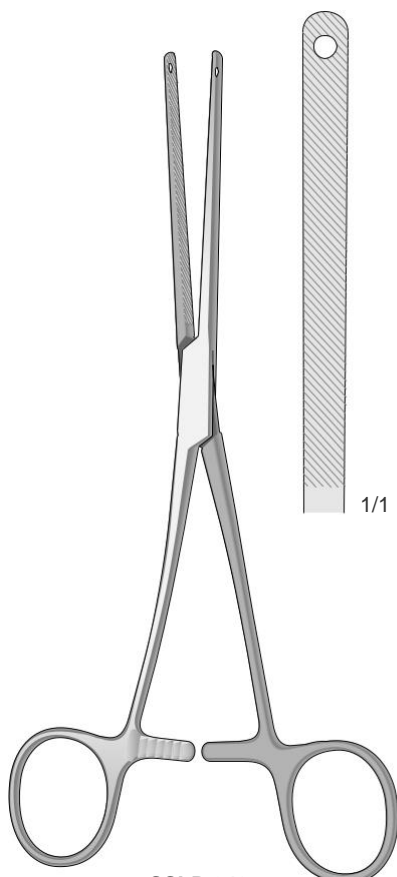


DB-300

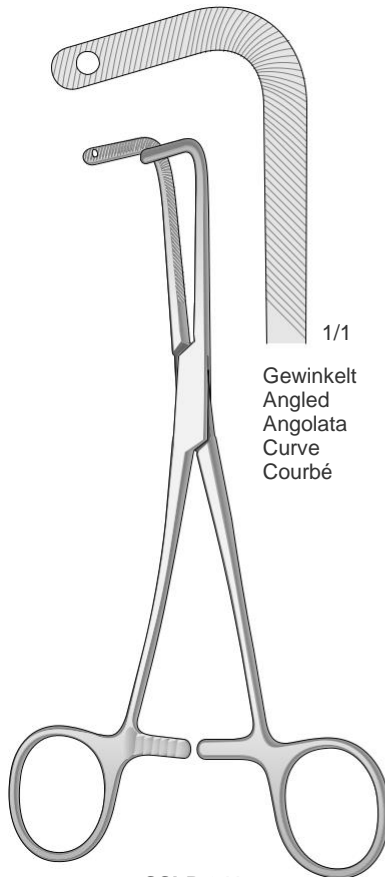
Schieblehre für Implantologie
 Implantology Calliper
 Calibro per Implantologie
 Calibre para Implantología
 Calibre pour Implantologie

Trei-Dimensional
 Tridimensional
 Tridimensionale
 Tridimensional
 Tridimensionnel

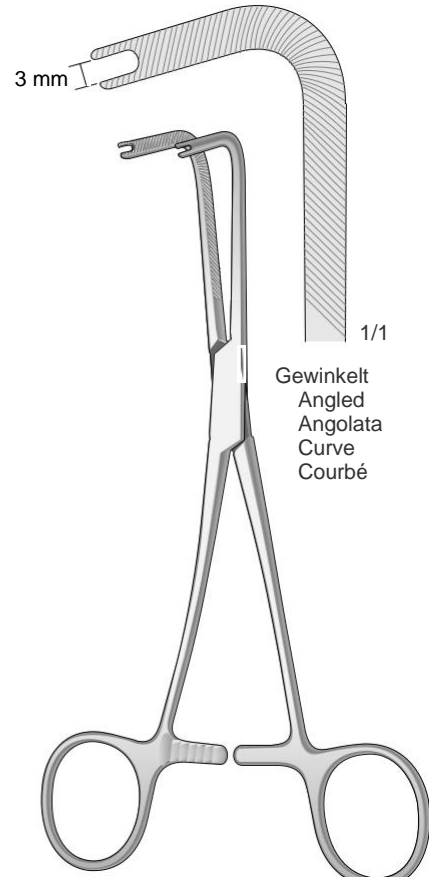
BONE BLOCK CLAMP
 Bone Holding Clamps
 Knochenhalteklammern
 Daviers à os
 Pinzas de sujeción para hueso
 Pinze per fissare l'osso



SSI-P-340
 220 mm



SSI-P-341
 200 mm



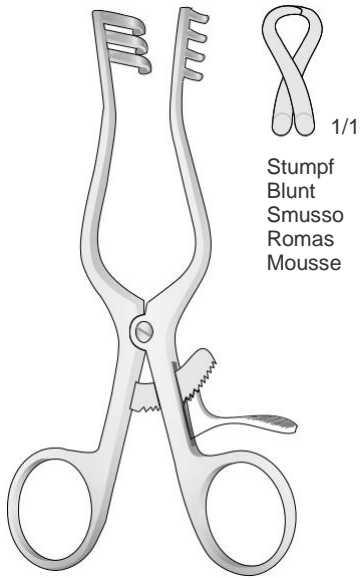
SSI-P-342
 200 mm

Email: sheffieldsurgicalinstruments@gmail.com
 Web: www.sheffieldsurgicalinst.com

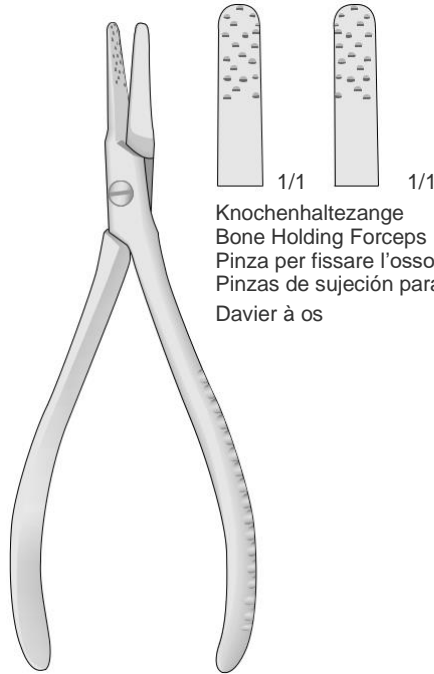


Retraktoren - Knochenhaltezeuge
 Retractors - Bone Holding Forceps
 Divaricatori - Pinza per fissare l'osso
 Separadores - Pinzas para sujeción para hueso
 Écarteurs - Daviers à os

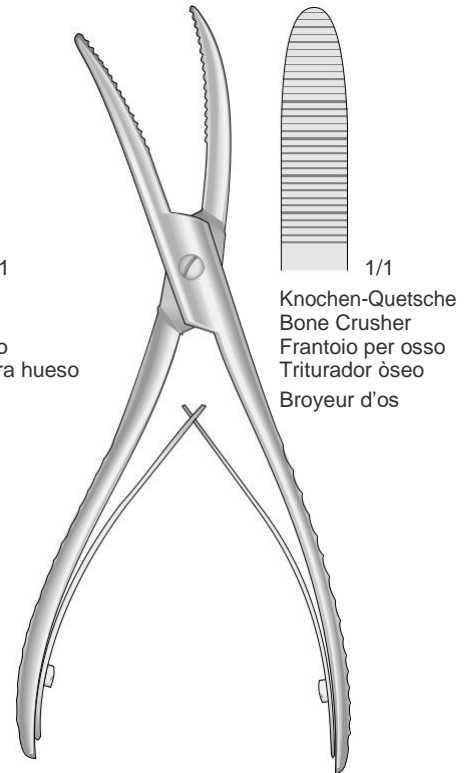
Tibia Wundspreizer Tibial and Iliac
 Retractor Divaricatore per tibia e
 cresta iliaca Separadores tibiales e
 iliacos Écarteur pour tibia e crête
 iliaque



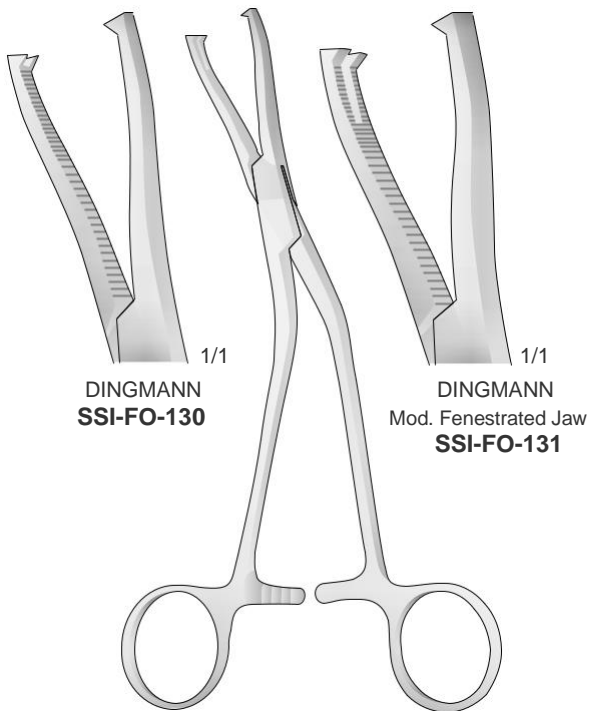
WEITLANER
SSI-BV-23
 165 mm



RADOLF
SSI-FO-159
 135 mm



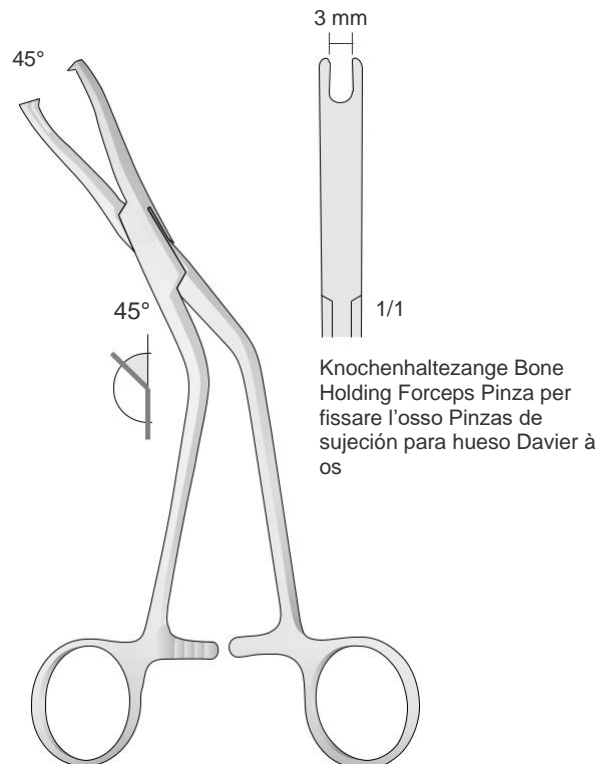
WOLFF
SSI-LX-113
 180 mm



DINGMANN
SSI-FO-130

DINGMANN
 Mod. Fenestrated Jaw
SSI-FO-131

DINGMANN
SSI-FO-130/SSI-FO-131
 190 mm



DINGMANN - Mod. Fenestrated Jaw
SSI-FO-131S
 190 mm

Email: sheffieldsurgicalinstruments@gmail.com
 Web: www.sheffieldsurgicalinst.com

Bone Rongeurs

Hohlmeißelzangen
Pinces gouges
Pinzas gubias
Pinze ossivore

Bone files

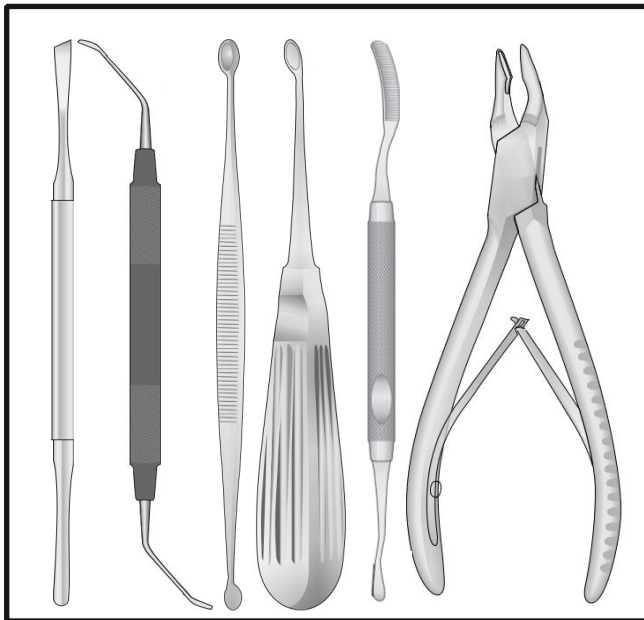
Knochenfeilen
Limes à os
Limas para hueso
Lime per osso

Curettes

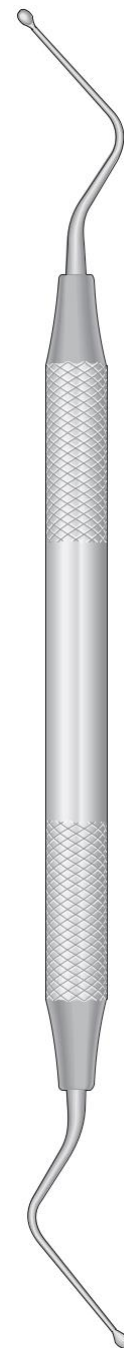
Küretten
Curettes
Curetas
Curettes

Periosteals (Raspatories)

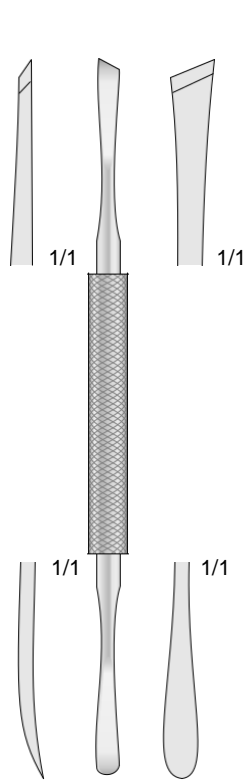
Raspatorien
Rugines périostiques
Periostótomos (Legras)
Scollaperiostei (Periostotomi)



Sheffield Surgical is highly experienced Manufacturer & exporter of high quality Dental Instruments and also in the field of General Surgery, Bone Surgery an Orthopedic Instruments.



Raspatorien
 Periosteals (Raspatories)
 Scollaperiosteai (Periostotomi)
 Periostótomos (Legras)
 Rugines périostiques



MEAD
165 mm

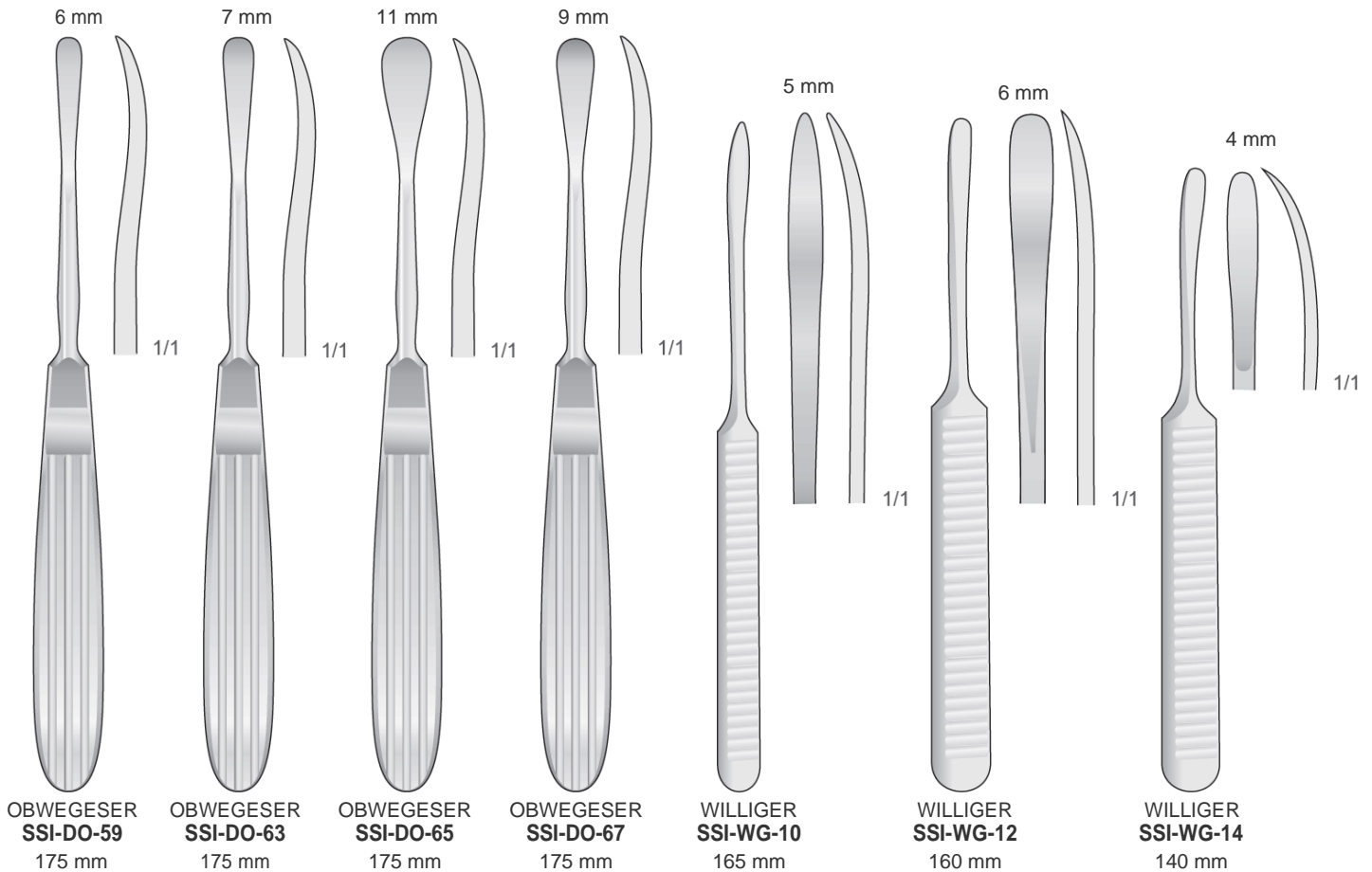


WEST
185 mm

**PERIOSTEAL
ELEVATORS**

Scharf - Sharp - Taglienti - Cortante - Tranchant

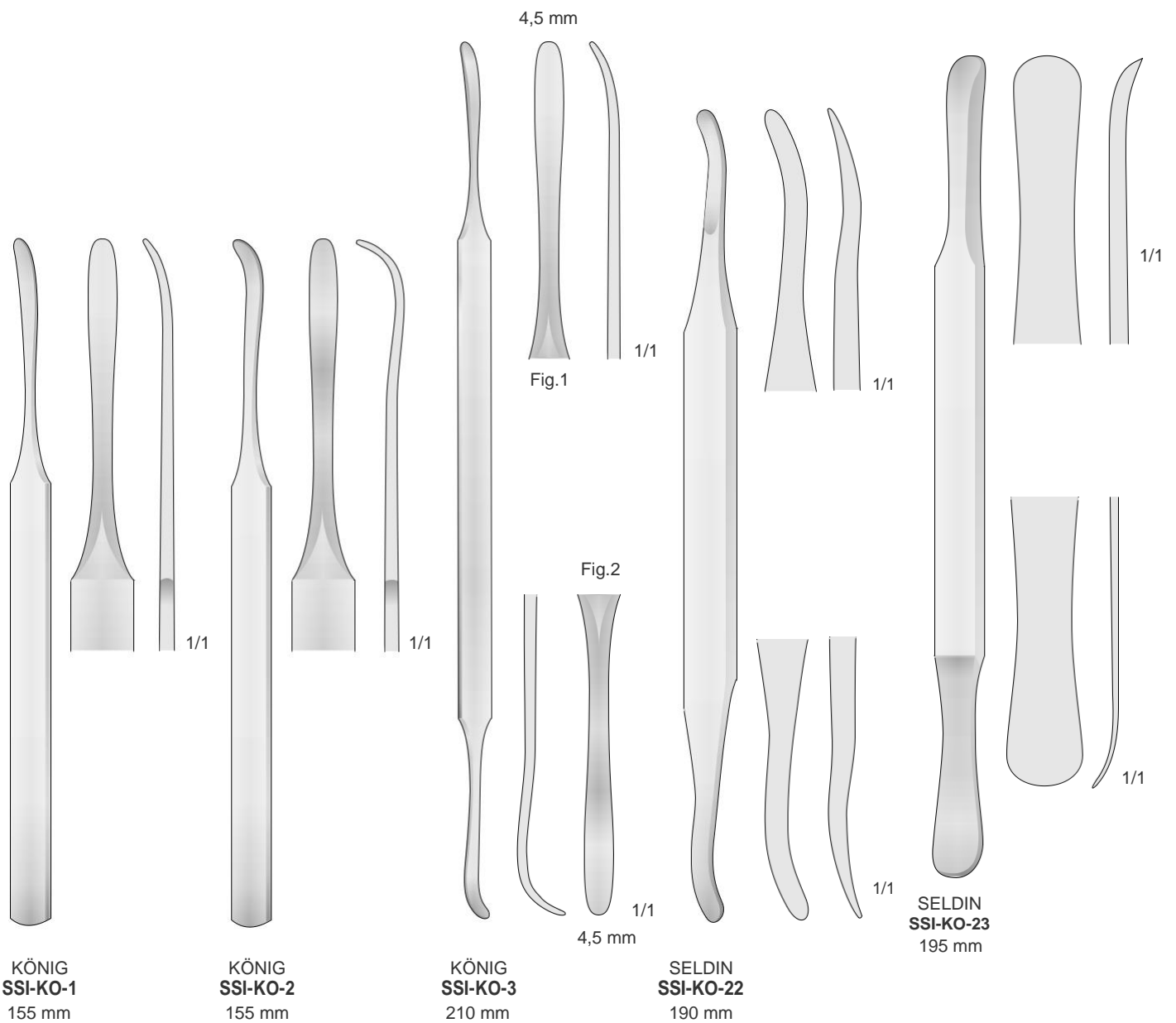
**PERIOSTEAL
RASPATORIES**



Email: sheffieldsurgicalinstruments@gmail.com
 Web: www.sheffieldsurgicalinst.com

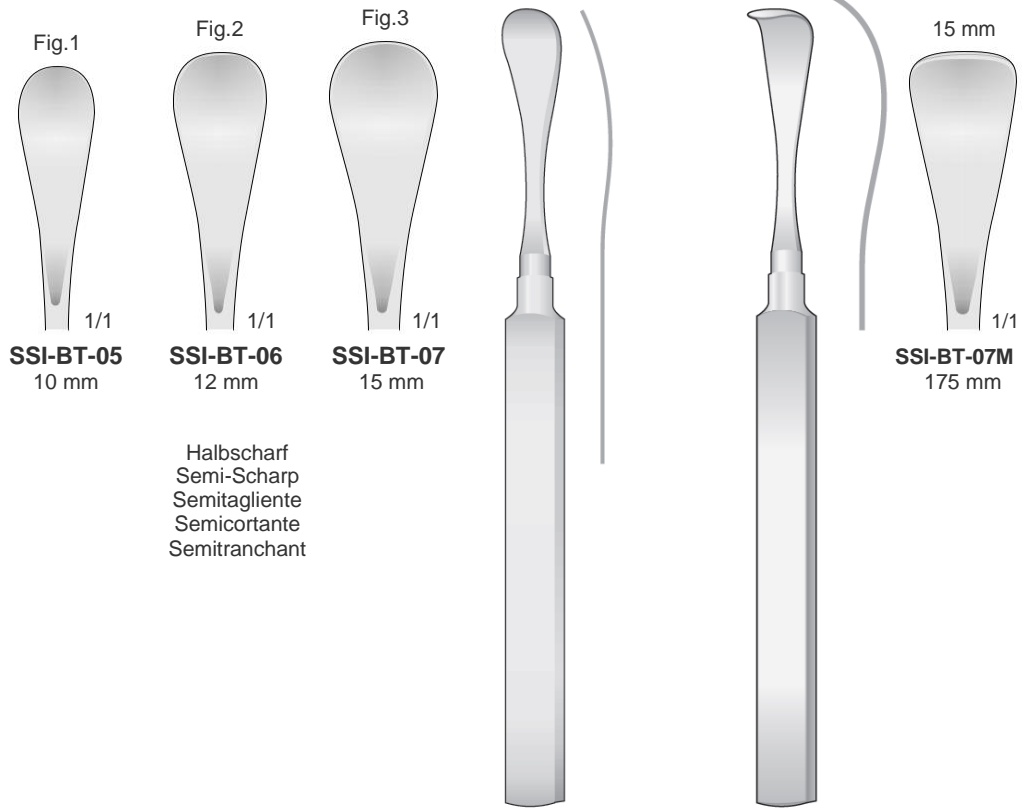


Raspatorien
Periosteals (Raspatories)
Scollaperiosteai (Periostotomi)
Periostótomos (Legras)
Rugines périostiques



Email: sheffieldsurgicalinstruments@gmail.com
Web: www.sheffieldsurgicalinst.com

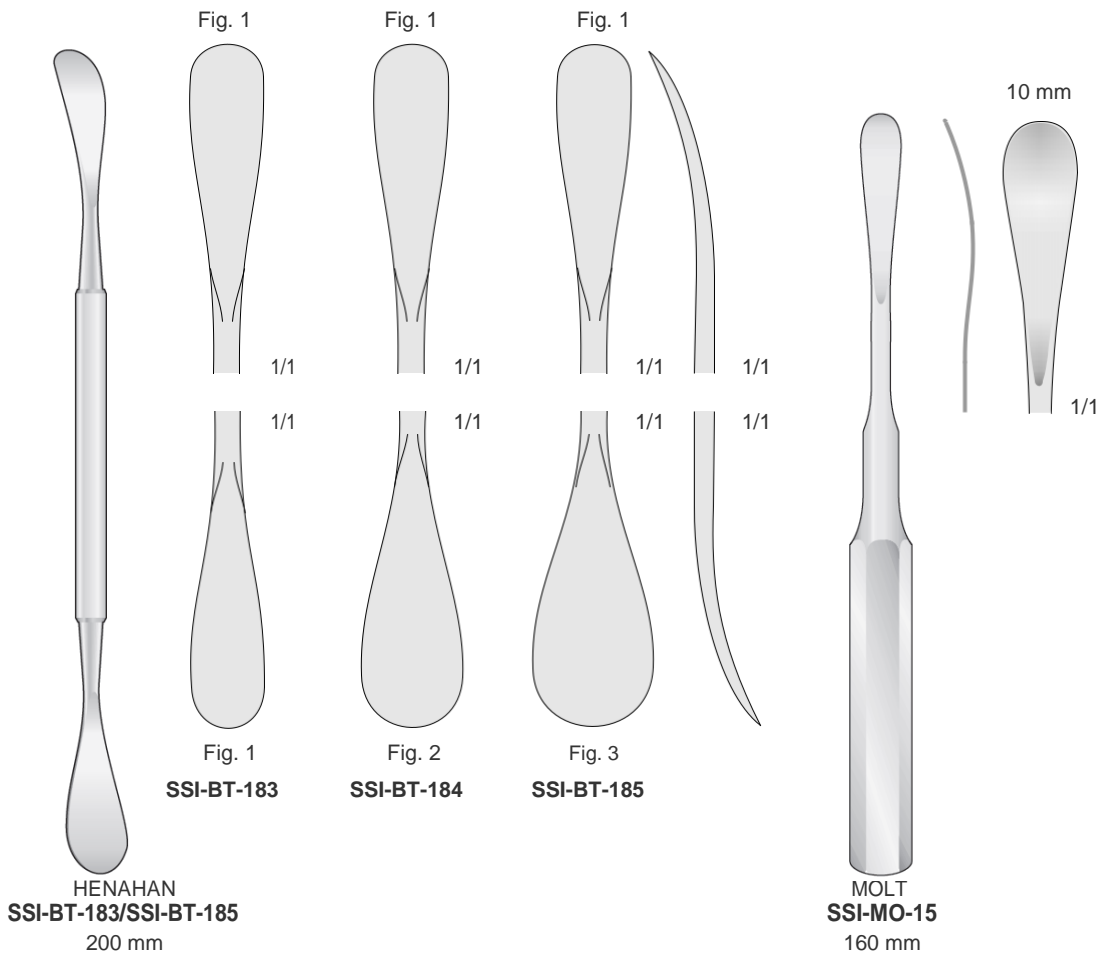
Raspatorien - Elevatorien
 Raspatories - Elevators
 Periostotomi - Elevatori
 Legras - Elevadores
 Rugines - Elevateurs



Halbscharf
 Semi-Scharp
 Semitagliente
 Semicortante
 Semitranchant

HENAHAN
 SSI-BT-05/SSI-BT-07
 175 mm

HENAHAN
 SSI-BT-07M
 175 mm



HENAHAN
 SSI-BT-183/SSI-BT-185
 200 mm

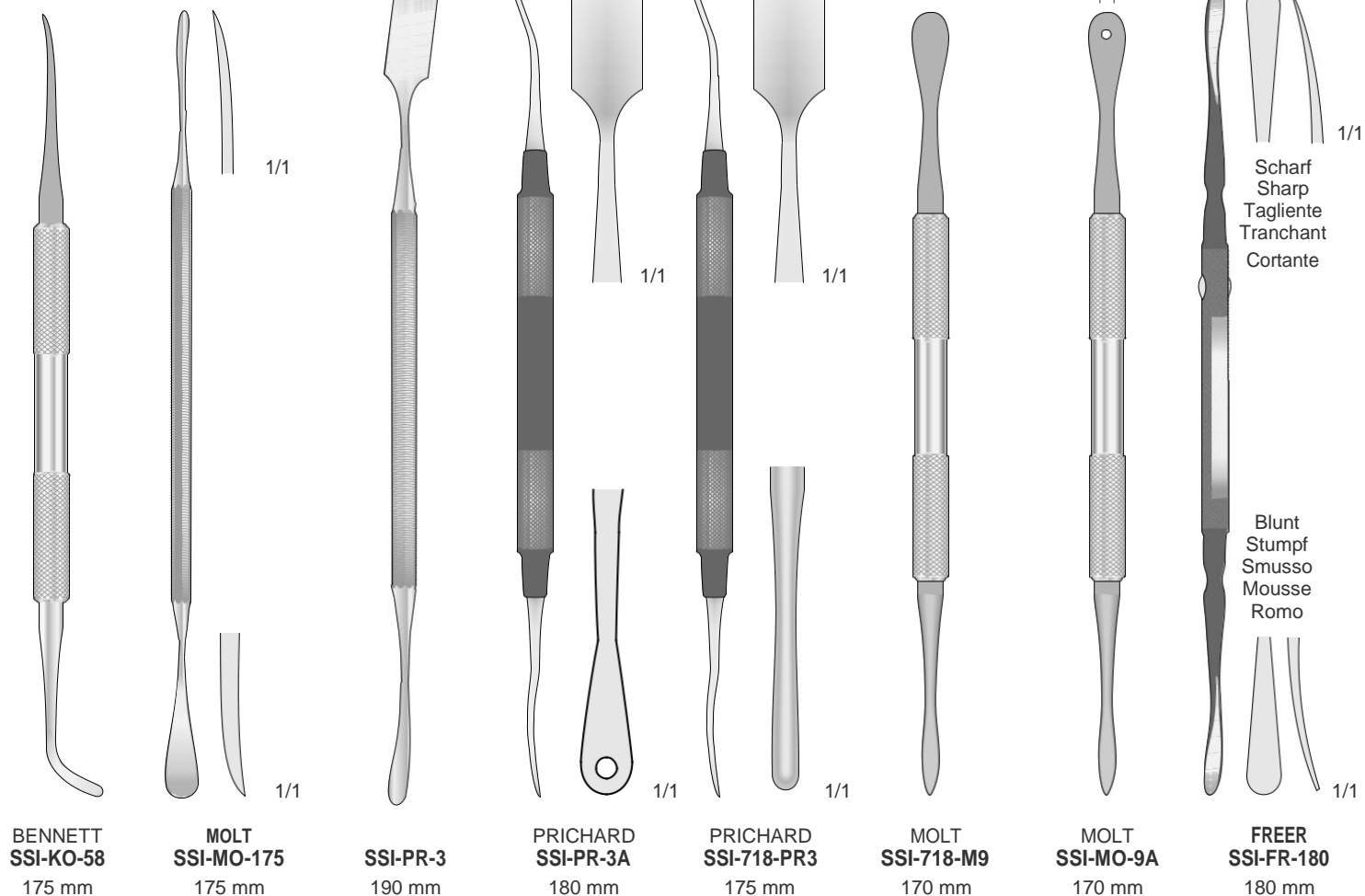
MOLT
 SSI-MO-15
 160 mm

Email: sheffieldsurgicalinstruments@gmail.com
 Web: www.sheffieldsurgicalinst.com



Raspatorien - Elevatorien
Raspatories - Elevators
Periostotomi - Elevatori
Legras - Elevadores
Rugines - Elevateurs

Fig. 12S

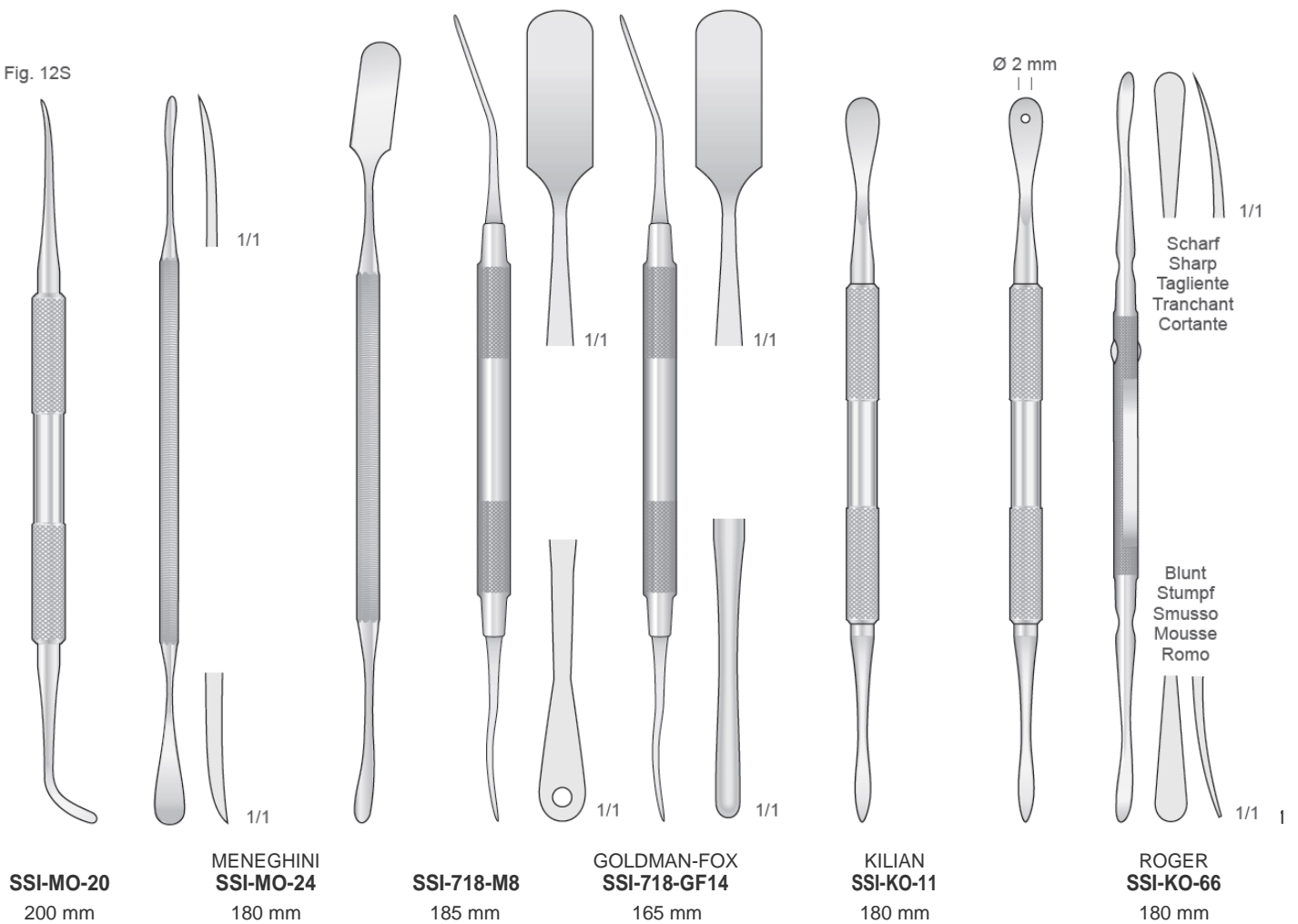


Email: sheffieldsurgicalinstruments@gmail.com
Web: www.sheffieldsurgicalinst.com

INSTRUMENTS

Raspatorien - Elevatorien
 Raspatories - Elevators
 Periostotomi - Elevatori
 Legras - Elevadores
 Rugines - Elevateurs

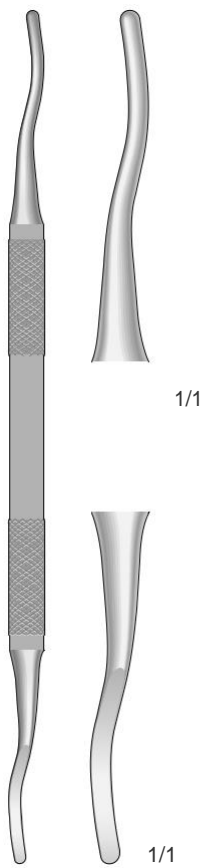
Fig. 12S



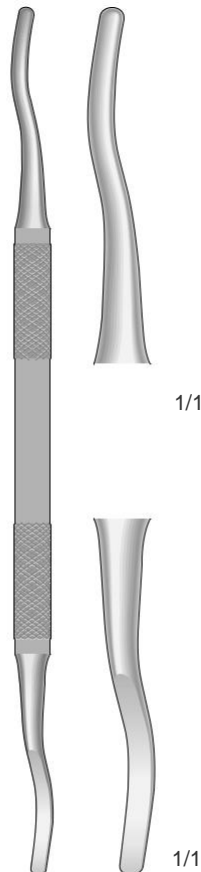
Email: sheffieldsurgicalinstruments@gmail.com
 Web: www.sheffieldsurgicalinst.com



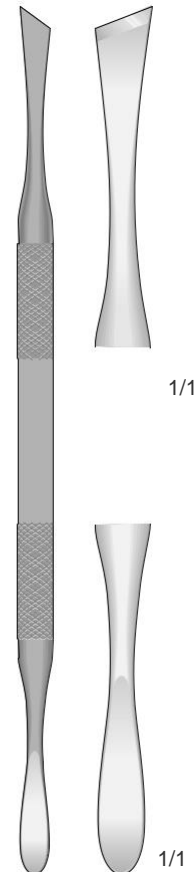
Raspatorien - Elevatorien
 Raspatories - Elevators
 Periostotomi - Elevatori
 Legras - Elevadores
 Rugines - Elevateurs



**HOPKINS
 SSI-718-191**
 185 mm

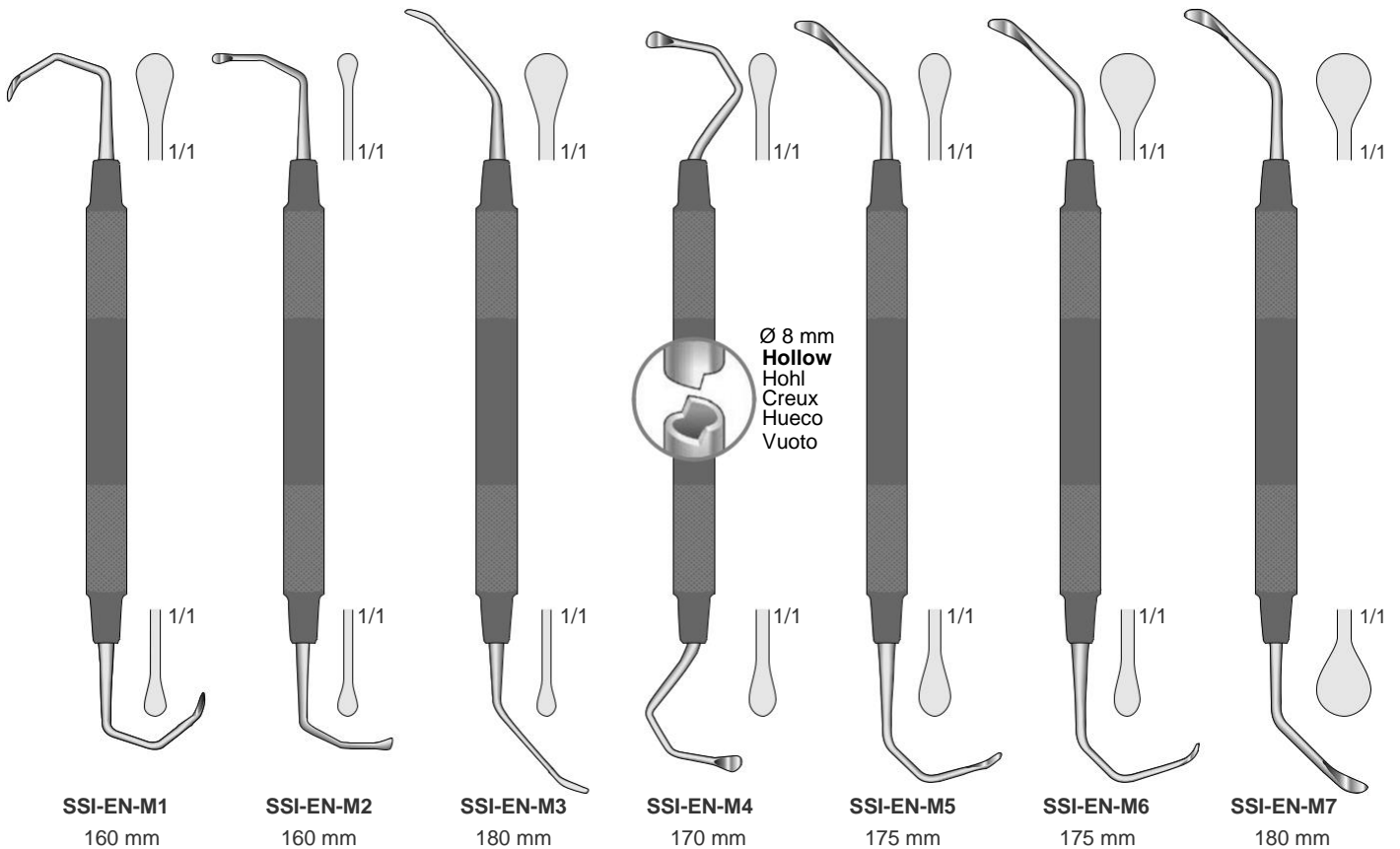


**HOPKINS
 SSI-718-192**
 185 mm



**MEAD
 SSI-718-223**
 185 mm

Instrumente für Sinuslift / Sinus Lift Instruments / Strumenti per rialzo del seno
 Instrumentos para elevación de seno maxilar / Instruments d'élévation sinusienne



SSI-EN-M1
 160 mm

SSI-EN-M2
 160 mm

SSI-EN-M3
 180 mm

SSI-EN-M4
 170 mm

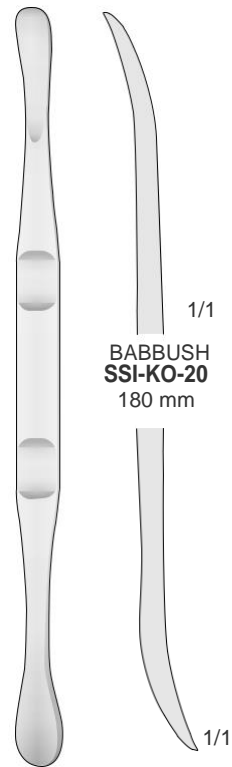
SSI-EN-M5
 175 mm

SSI-EN-M6
 175 mm

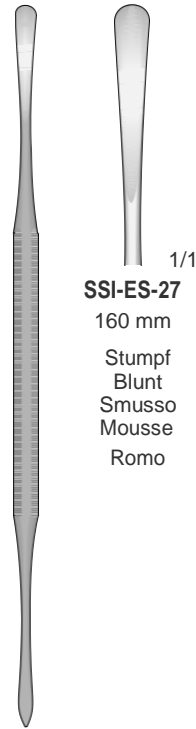
SSI-EN-M7
 180 mm

Email: sheffieldsurgicalinstruments@gmail.com
 Web: www.sheffieldsurgicalinst.com

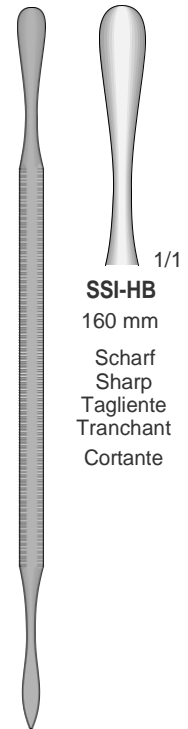
Raspatorien - Elevatorien
 Raspatories - Elevators
 Periostotomi - Elevatori
 Legras - Elevadores
 Rugines - Elevateurs



BABBUSH
SSI-KO-20
 180 mm



SSI-ES-27
 160 mm
 Stumpf
 Blunt
 Smusso
 Mousse
 Romo



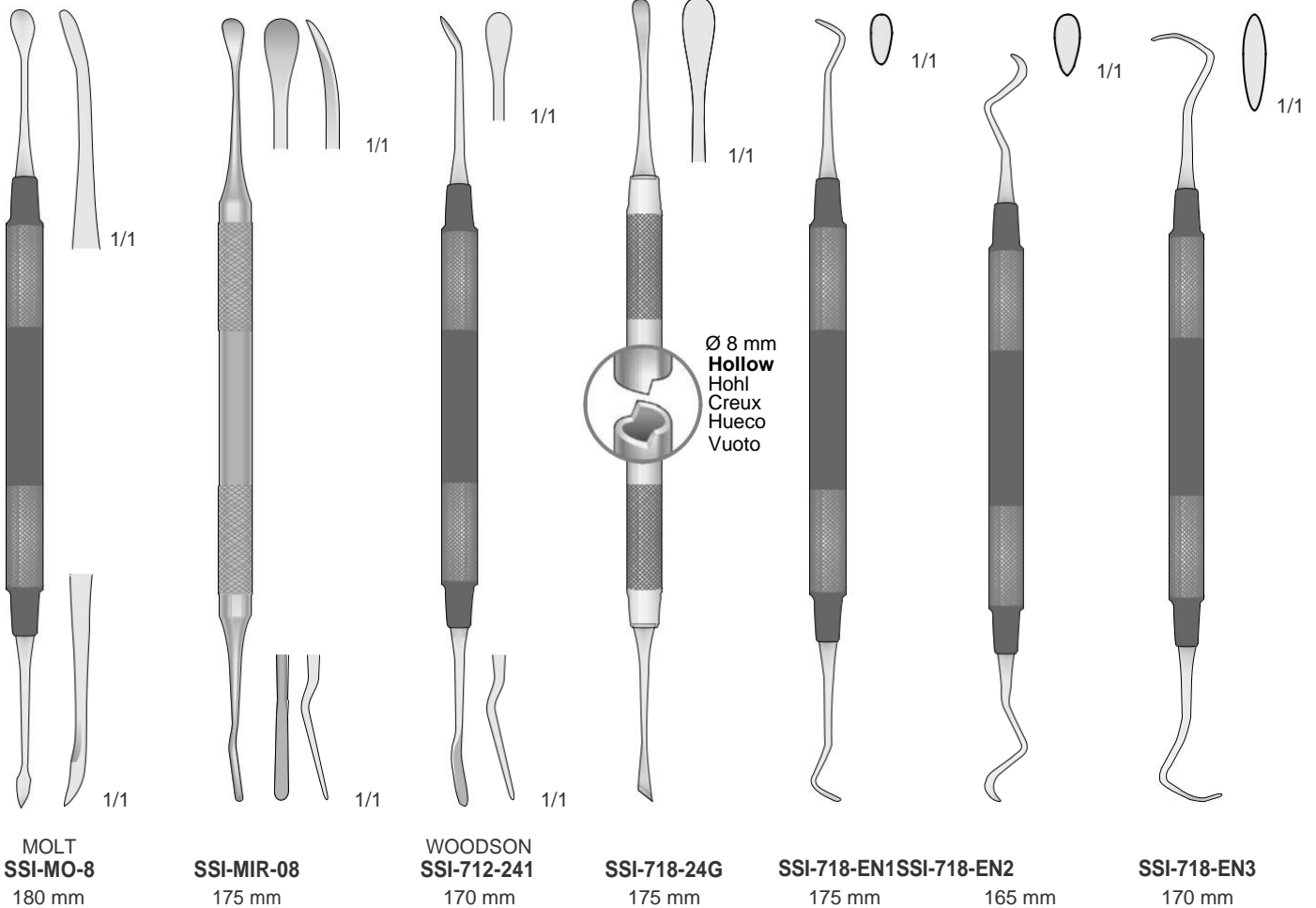
SSI-HB
 160 mm
 Scharf
 Sharp
 Tagliente
 Tranchant
 Cortante

Fig. 24G

Instrumente für Sinuslift
 Sinus Lift Instruments

Strumenti per rialzo del seno

Instrumentos para elevación de seno maxilar
 Instruments d'élévation sinusienne



Ø 8 mm
Hollow
 Hohl
 Creux
 Hueco
 Vuoto

MOLT
SSI-MO-8
 180 mm

SSI-MIR-08
 175 mm

WOODSON
SSI-712-241
 170 mm

SSI-718-24G
 175 mm

SSI-718-EN1
SSI-718-EN2
 175 mm 165 mm

SSI-718-EN3
 170 mm

Email: sheffieldsurgicalinstruments@gmail.com
 Web: www.sheffieldsurgicalinst.com

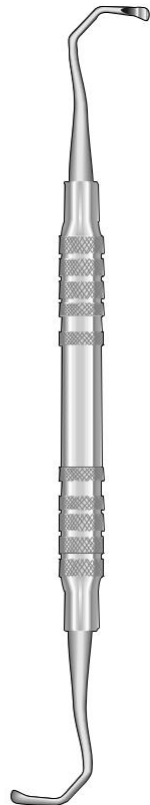


Raspatorien - Elevatorien
Raspatories - Elevators
Periostotomi - Elevatori
Legras - Elevadores
Rugines - Elevateurs



Ø 8 mm
Hollow
Hohl
Creux
Hueco
Vuoto

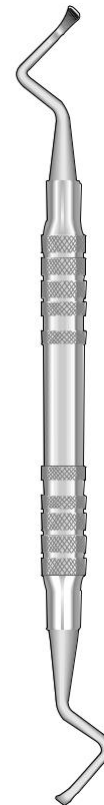
SSI-TASO-1



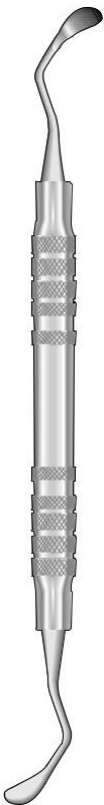
SSI-TASO-2



SSI-TASO-3



SSI-TASO-4



SSI-TASO-5



SSI-TASO-6



SSI-TASO-7



Ø 8 mm
Hollow
Hohl
Creux
Hueco
Vuoto

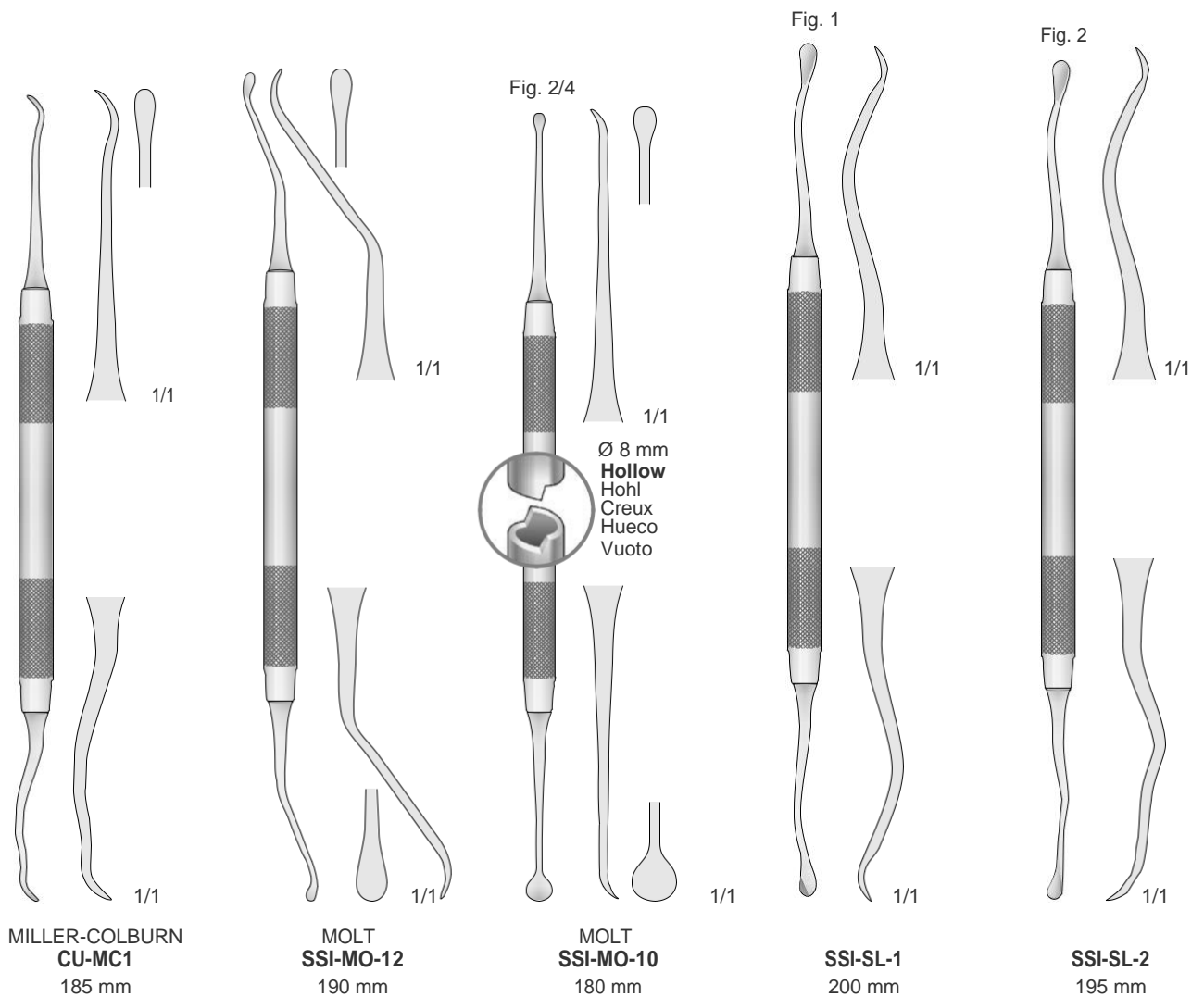
SSI-TASO-8

Email: sheffieldsurgicalinstruments@gmail.com
Web: www.sheffieldsurgicalinst.com

Raspatorien
Raspatories
Periostotomi
Legras
Rugines

Curettes
Küretten
Curettes
Curetas
Curettes

Instrumente für Sinuslift
Sinus Lift Instruments
Strumenti per rialzo del seno
Instrumentos para elevación de seno maxilar
Instruments d'élévation sinusienne

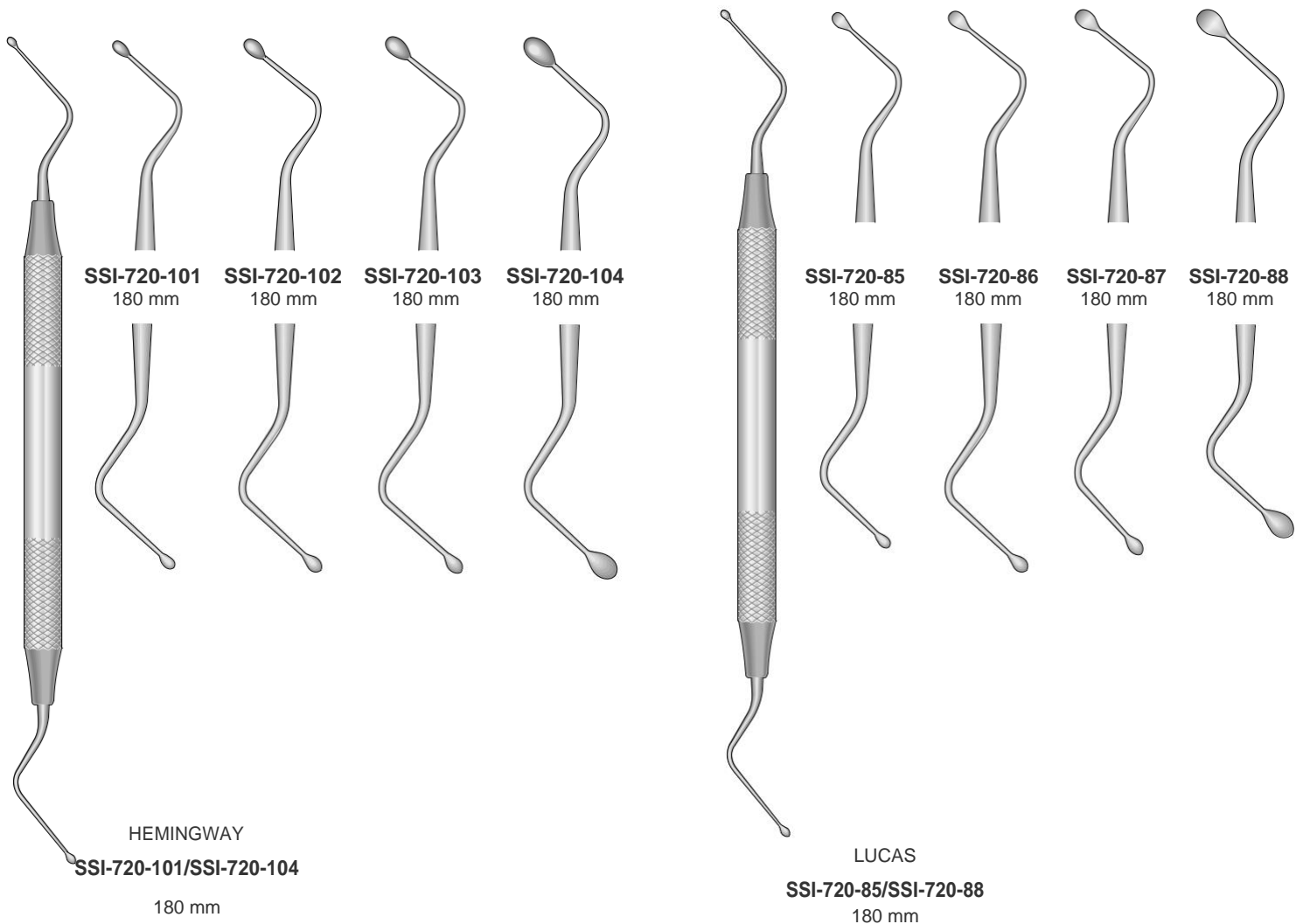


Email: sheffieldsurgicalinstruments@gmail.com
Web: www.sheffieldsurgicalinst.com



Küretten
Curettes
Curettes
Curetas
Curettes

Runder Hohlgriff 8 mm
Hollow Round Handle 8 mm
Manico tondo vuoto 8 mm
Mango hueco 8 mm
Manche rond vide 8 mm



Email: sheffieldsurgicalinstruments@gmail.com
Web: www.sheffieldsurgicalinst.com

Küretten
Curettes
Curettes
Curetas
Curettes

Wundhachen Mandibular
Mandibular Nerve Diplace
Per spostamento
nervo mandibolare
Para nero mandibular



HEMINGWAY
SSI-C-1
170 mm



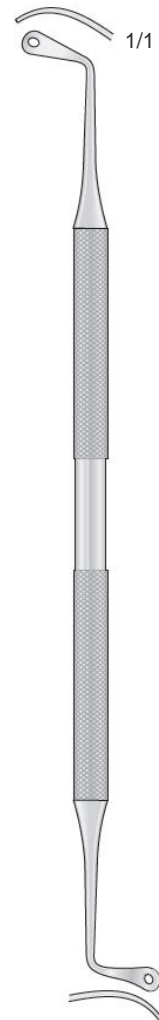
HEMINGWAY
SSI-C-2
170 mm



HEMINGWAY
SSI-C-3
170 mm



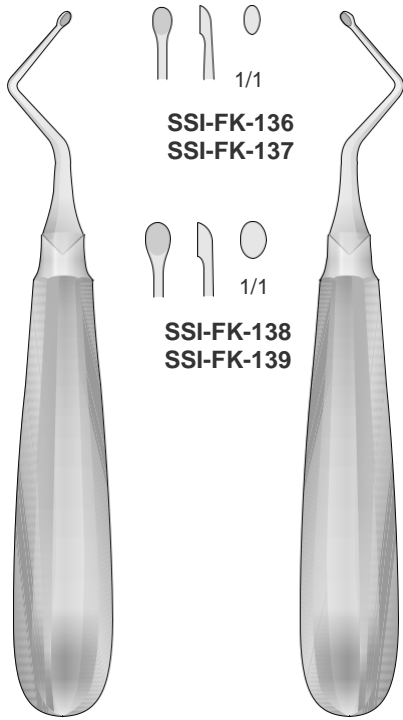
HEMINGWAY
SSI-C-4
170 mm



SSI-SL-21
165 mm



Küretten
Curettes
Curettes
Curetas
Curettes



SSI-FK-136
SSI-FK-137

SSI-FK-138
SSI-FK-139

KERPEL
SSI-FK-136
SSI-FK-138
145 mm

KERPEL
SSI-FK-137
SSI-FK-139
145 mm



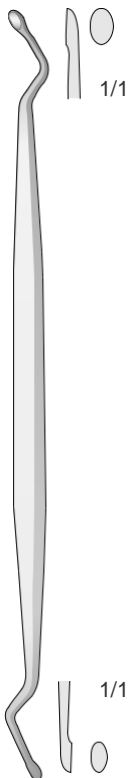
SSI-DL-50
155 mm



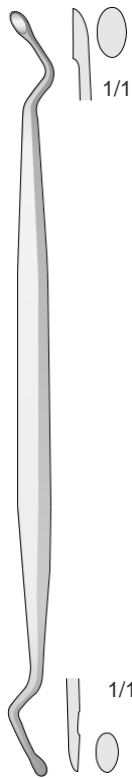
SSI-DL-51
150 mm



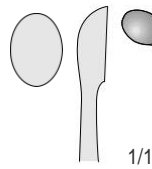
SSI-DL-52
150 mm



SSI-FK-83
160 mm



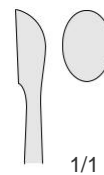
JANSEN
SSI-FK-84
160 mm



UFFENORDE
SSI-FK-188
170 mm



UFFENORDE
SSI-FK-189
170 mm



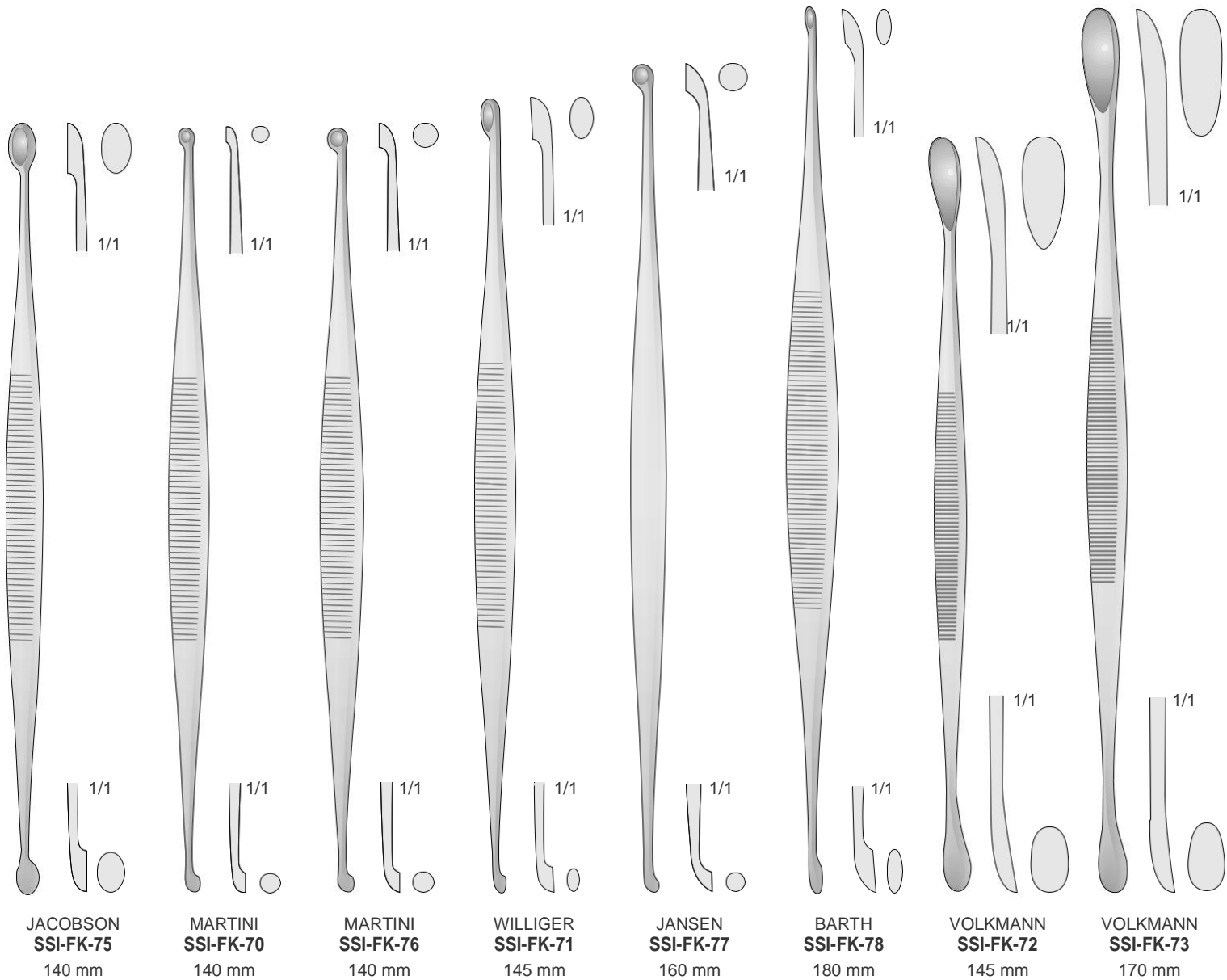
WILLIGER
SSI-FK-197/SSI-FK-198
170 mm

Fig. 00
3,4 mm
1/1
SSI-FK-197

Fig. 1
5,2 mm
1/1
SSI-FK-198

Email: sheffieldsurgicalinstruments@gmail.com
Web: www.sheffieldsurgicalinst.com

Küretten
Curettes
Curettes
Curetas
Curettes











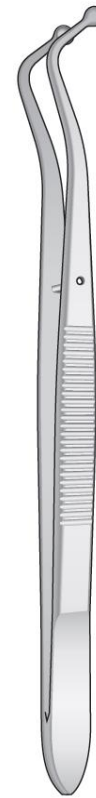
Email: sheffieldsurgicalinstruments@gmail.com
Web: www.sheffieldsurgicalinst.com



Küretten
Curettes
Curettes
Curetas
Curettes

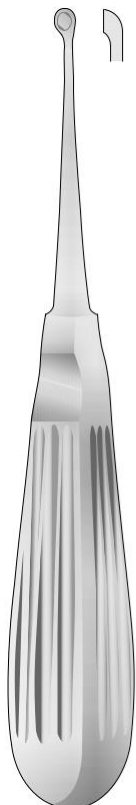








- | | | | |
|---|--|---|---|
| Fig.0000 2,8 mm  1/1 SSI-FK-60 | Fig.000 3,6 mm  1/1 SSI-FK-61 | Fig.00 4,4 mm  1/1 SSI-FK-62 | ,Fig.0 5,2 mm  1/1 SSI-FK-63 |
| Fig.1 6,8 mm  1/1 SSI-FK-64 | Fig.2 8,5 mm  1/1 SSI-FK-65 | Fig.3 10 mm  1/1 SSI-FK-66 | Fig.4 11,5 mm  1/1 SSI-FK-67 |

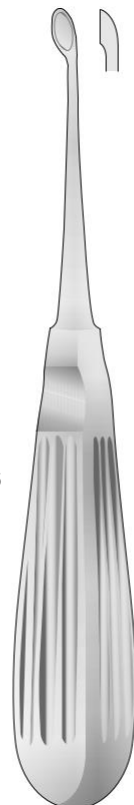








COLLEGE CURETTE
SSI-MIR-10
160 mm

VOLKMANN
SSI-FK-60/SSI-FK-67
170 mm



- | | | |
|--|--|---|
| 3 mm  1/1 SSI-FK-110 | 4 mm  1/1 SSI-FK-111 | 5 mm  1/1 SSI-FK-112 |
| 6 mm  1/1 SSI-FK-113 | 8 mm  1/1 SSI-FK-114 | 12 mm  1/1 SSI-FK-116 |



- | | | |
|--|--|--|
| 2,5 mm  1/1 SSI-FK-120 | 3,4 mm  1/1 SSI-FK-121 | 4,2 mm  1/1 SSI-FK-122 |
| 5,2 mm  1/1 SSI-FK-123 | 6,3 mm  1/1 SSI-FK-124 | 8 mm  1/1 SSI-FK-126 |

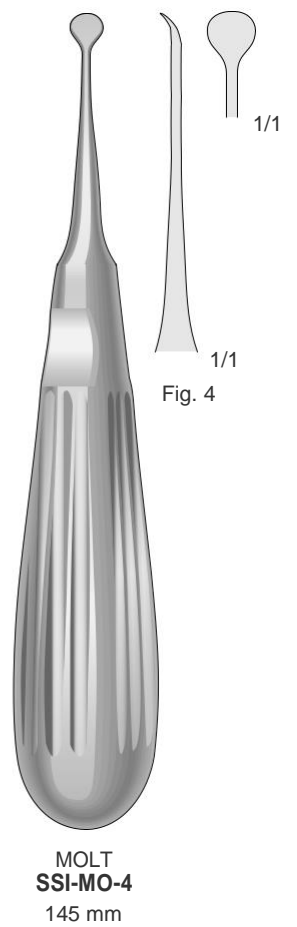
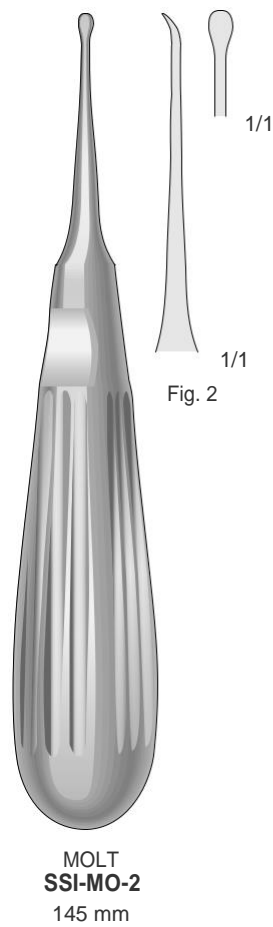
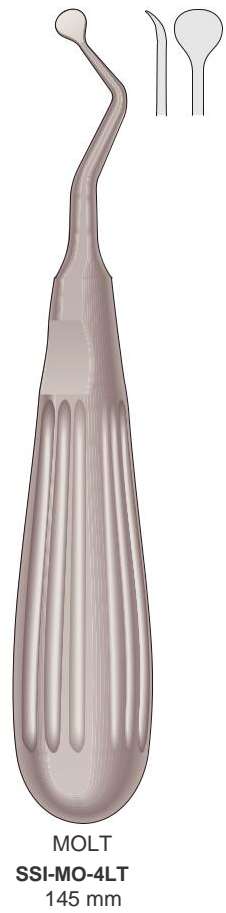
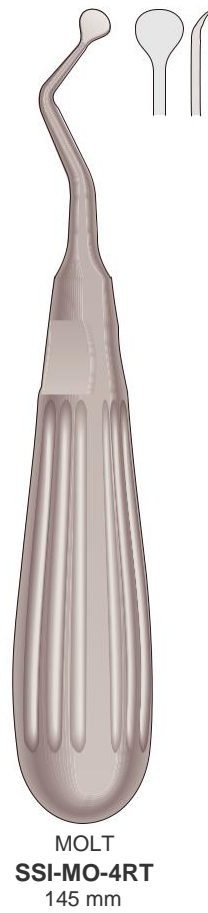
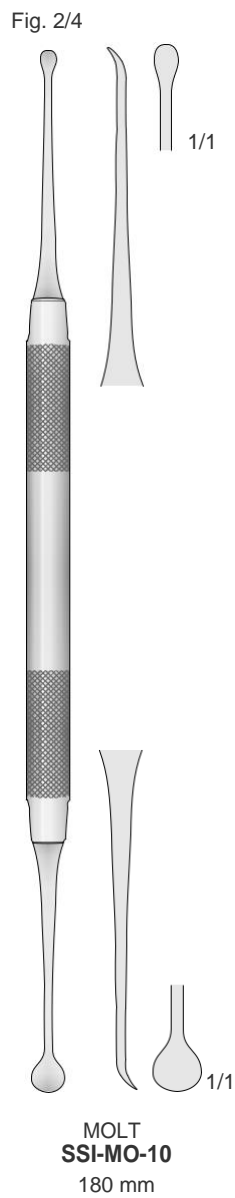
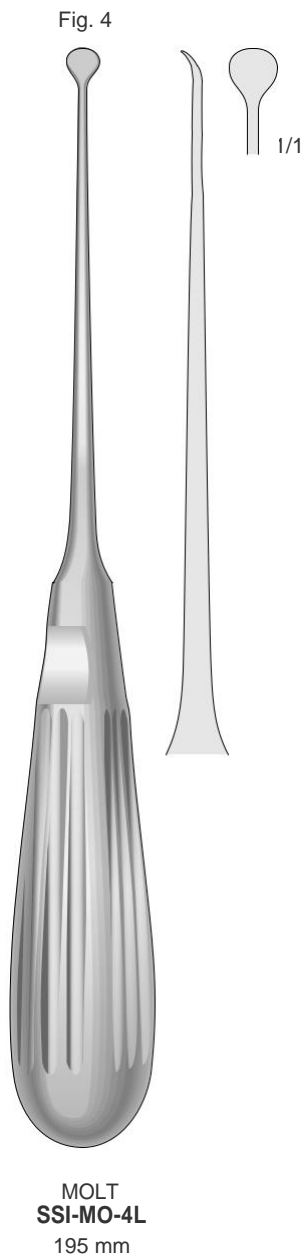
BRUNS
SSI-FK-110/SSI-FK-116
165 mm

SCHEDE
SSI-FK-120/SSI-FK-126
170 mm

Email: sheffieldsurgicalinstruments@gmail.com
Web: www.sheffieldsurgicalinst.com



Chirurgische Küretten
Surgical Curettes
Curette chirurgie
Curetas quirúrgicas
Curettes chirurgicales

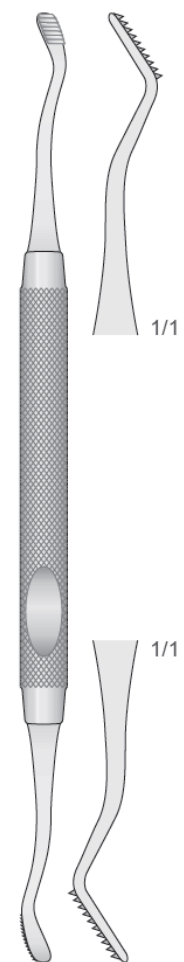


Email: sheffieldsurgicalinstruments@gmail.com
Web: www.sheffieldsurgicalinst.com



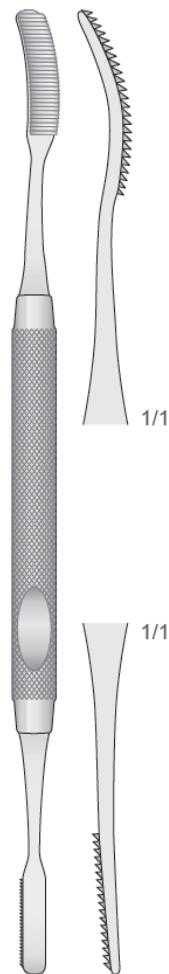
Knochenfeilen
Bone Files Lime
per osso Limes
para hueso Limes
à os

Fig. 67



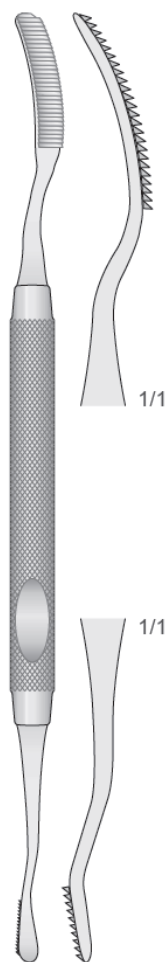
HOWARD
SSI-DO-1
180 mm

Fig. 45



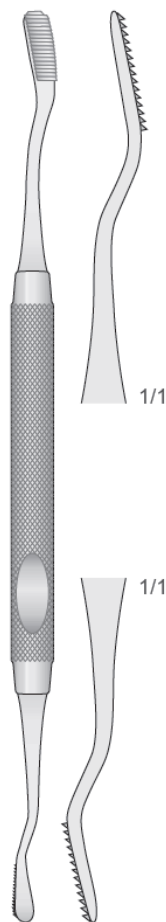
MILLER
SSI-DO-2
185 mm

Fig. 52



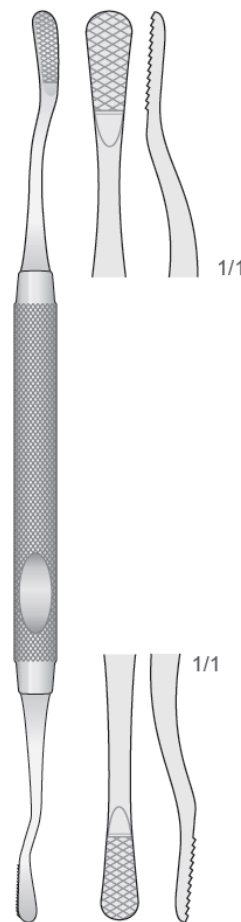
MILLER
SSI-DO-3
180 mm

Fig. 12



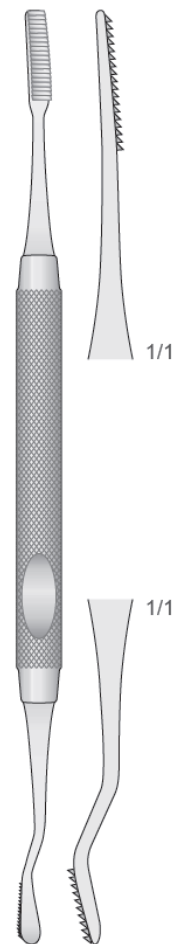
HOWARD
SSI-DO-4
170 mm

Fig. 12A



MILLER
SSI-DO-4C
170 mm

Fig. 64

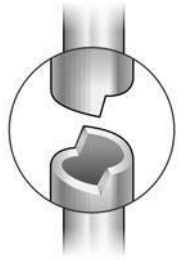


MILLER
SSI-DO-5
175 mm

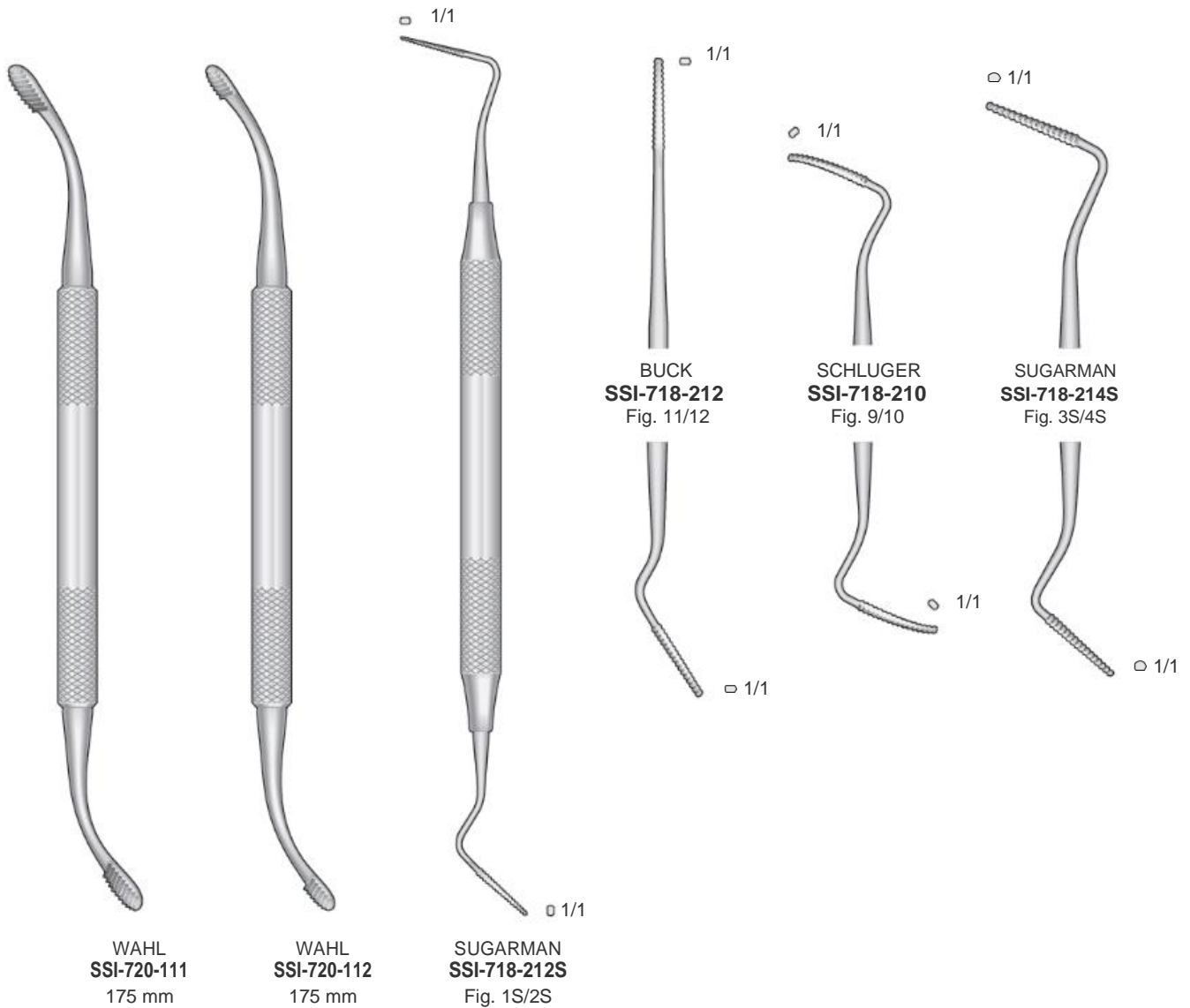
Email: sheffieldsurgicalinstruments@gmail.com
Web: www.sheffieldsurgicalinst.com

Knochenfeilen
 Bone Files Lime
 per osso Limas
 para hueso Limes
 à os

Runder Hohlgriff 8 mm
 Hollow Round Handle 8 mm
 Manico tondo vuoto 8 mm
 Mango hueco 8 mm
 Manche rond vide 8 mm



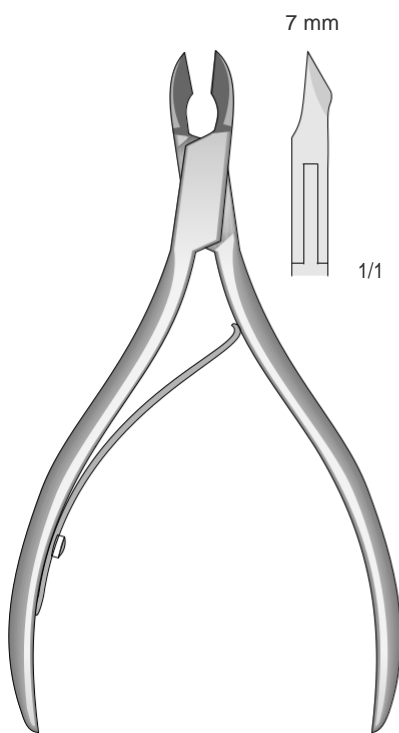
Parodontal Feilen
 Periodontal Files
 Lime parodontali
 Limas periodontales
 Limes parodontales



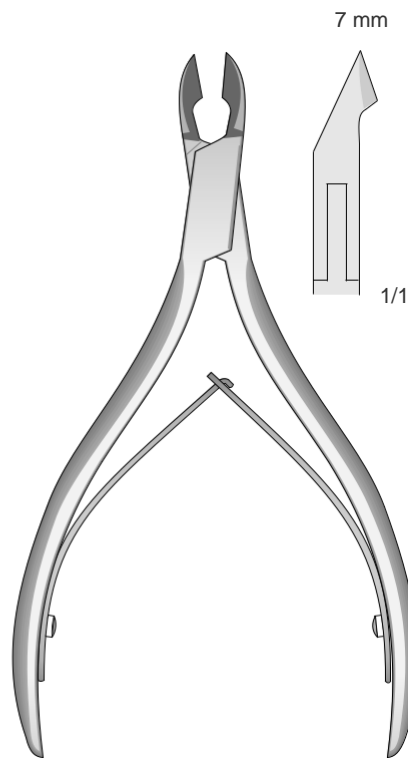
Email: sheffieldsurgicalinstruments@gmail.com
 Web: www.sheffieldsurgicalinst.com



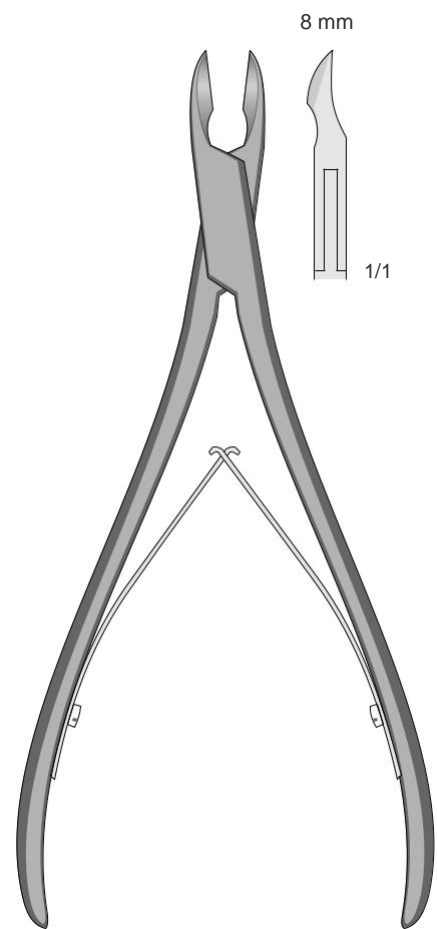
Gewebezängchen
Tissue Nippers
Tronchesi per gengive e tessuti
Pinzas para cortar tejidos
Pincas coupante pour tissue



CHOEN
SSI-LX-60
105 mm



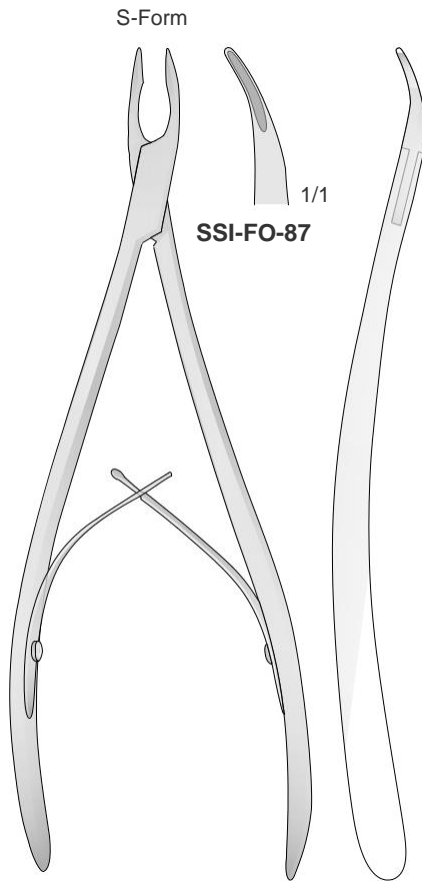
ILIC
SSI-LX-50
115 mm



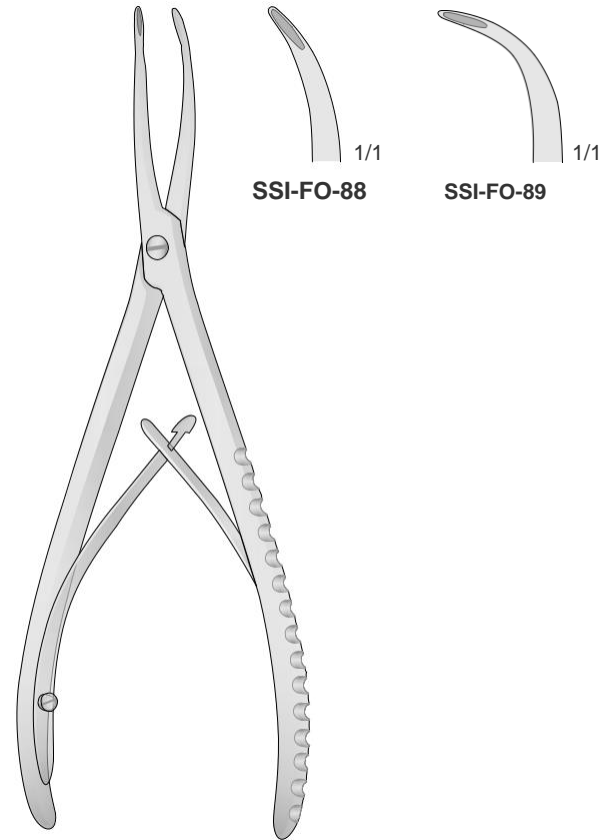
SSI-LX-52
140 mm

Email: sheffieldsurgicalinstruments@gmail.com
Web: www.sheffieldsurgicalinst.com

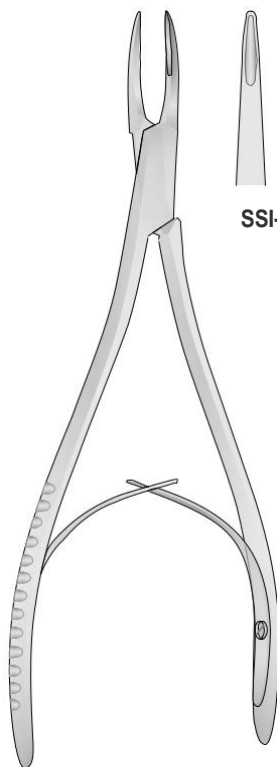
Hohlmeißelzangen
 Bone rongeurs
 Pinze ossivore
 Pinzas gubias
 Pincas gouges



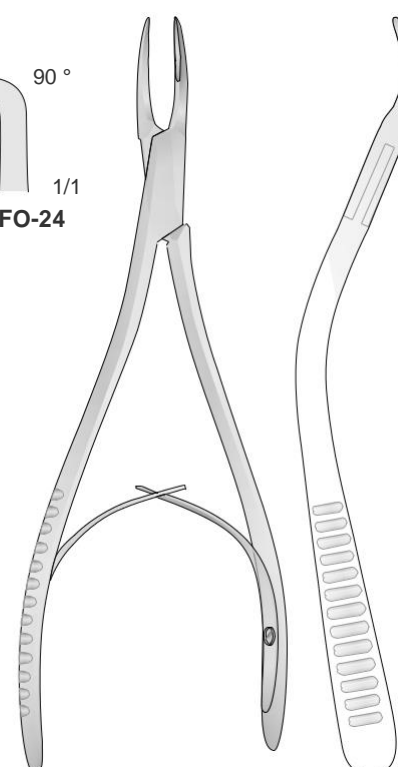
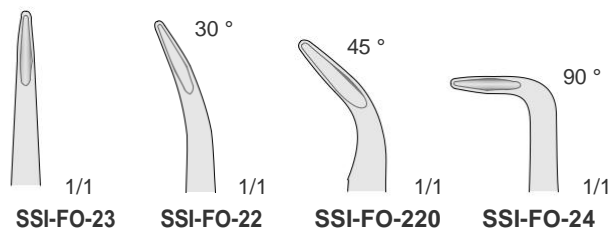
STELLBRINK
SSI-FO-87
 190 mm



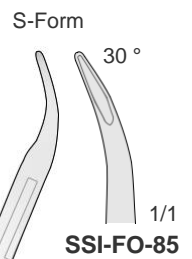
STELLBRINK
SSI-FO-88/SSI-FO-89
 170 mm



MINI-FRIEDMANN
SSI-FO-22/SSI-FO-220
 150 mm

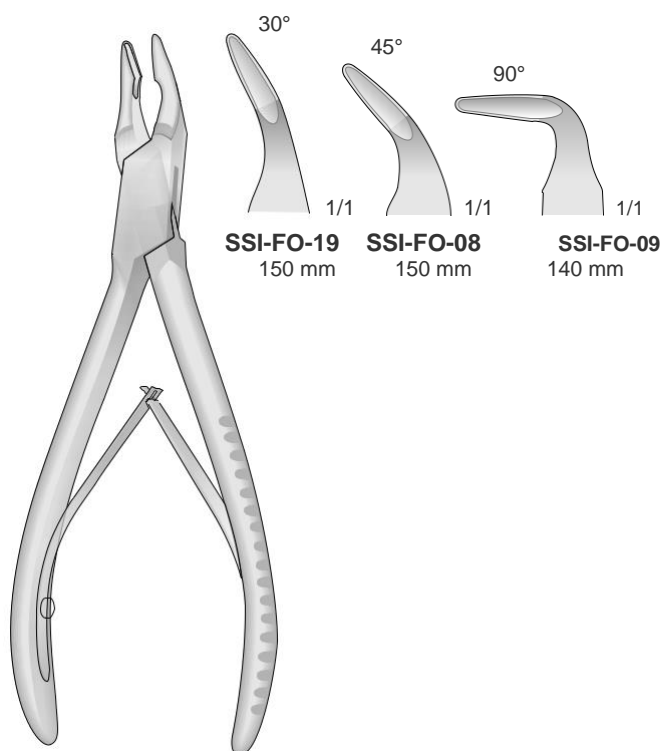


MINI-FRIEDMANN
SSI-FO-85
 145 mm

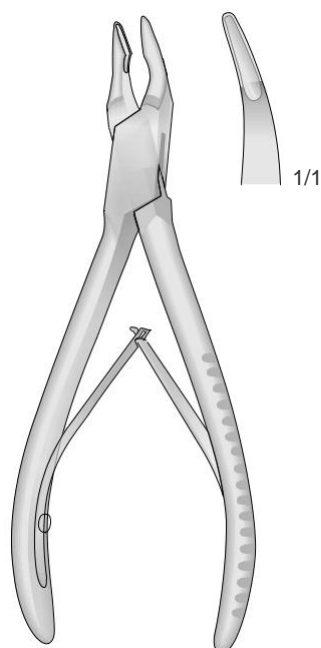


Email: sheffieldsurgicalinstruments@gmail.com
 Web: www.sheffieldsurgicalinst.com

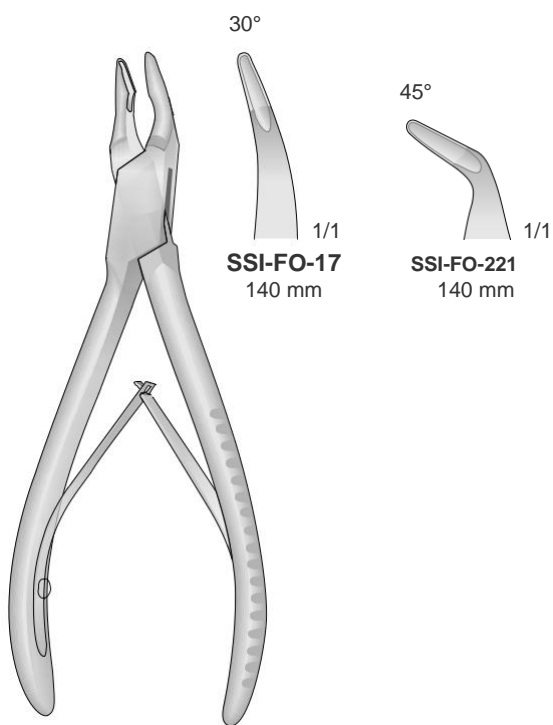
Hohlmeißelzangen
 Bone rongeurs
 Pinze ossivore
 Pinzas gubias
 Pincas gouges



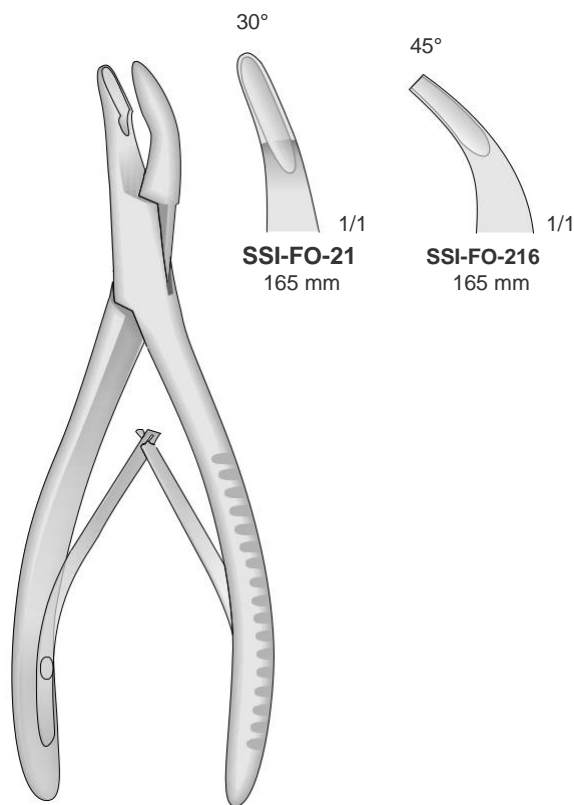
BLUMENTHAL
 SSI-FO-08/SSI-FO-19



MINI FRIEDMAN
 SSI-FO-15
 120 mm



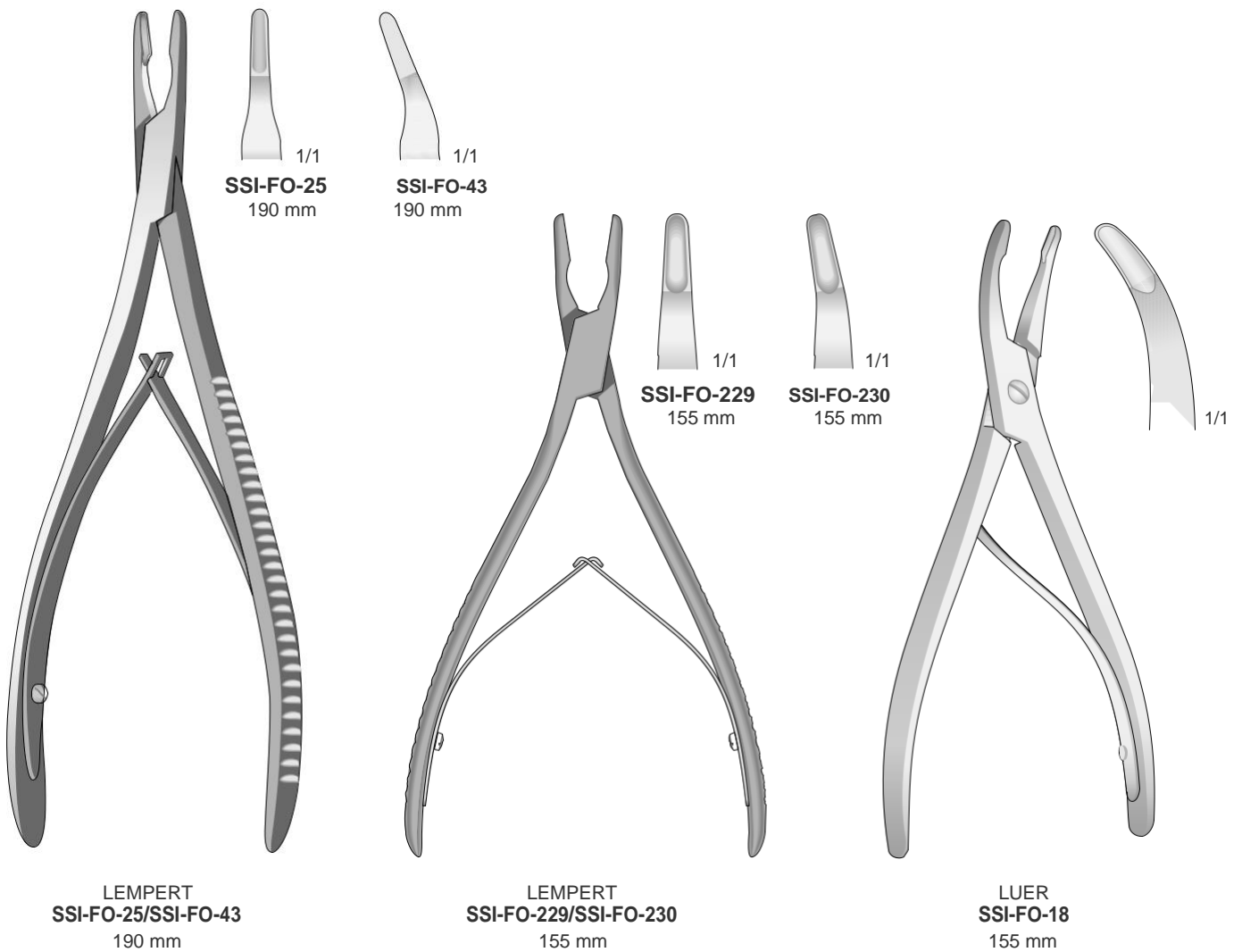
FRIEDMANN
 SSI-FO-17/SSI-FO-221
 140 mm



MEAD
 SSI-FO-21/SSI-FO-216
 165 mm

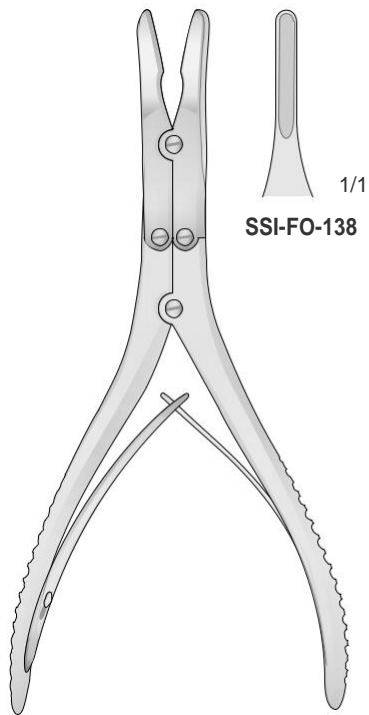
Email: sheffieldsurgicalinstruments@gmail.com
 Web: www.sheffieldsurgicalinst.com

Hohlmeißelzangen
 Bone rongeurs
 Pinze ossivore
 Pinzas gubias
 Pincas gouges

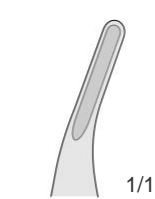


Email: sheffieldsurgicalinstruments@gmail.com
 Web: www.sheffieldsurgicalinst.com

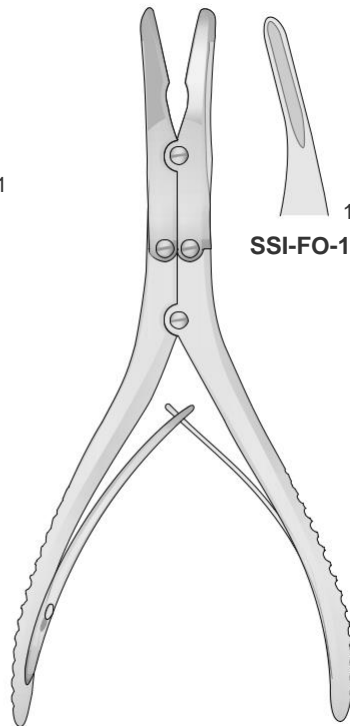
Hohlmeißelzangen
 Bone rongeurs
 Pinze ossivore
 Pinzas gubias
 Pincas gouges



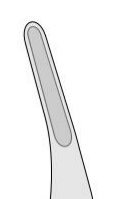
SSI-FO-138



SSI-FO-139



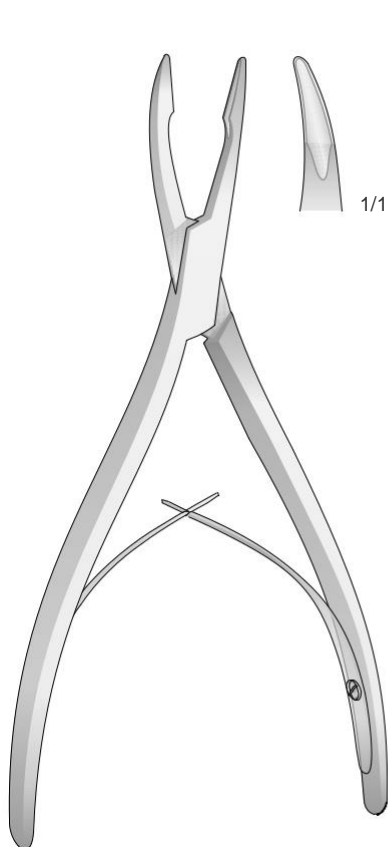
SSI-FO-156



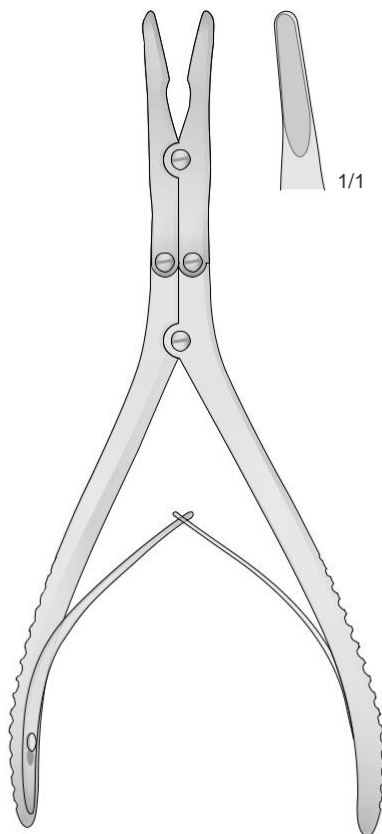
SSI-FO-157

RUSKIN
 SSI-FO-138/SSI-FO-139
 150 mm

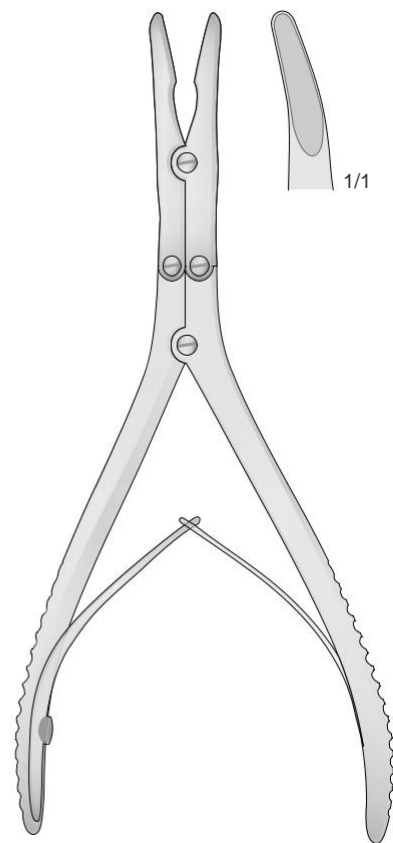
KLEINERT-KUTZ
 SSI-FO-156/SSI-FO-157
 155 mm



FRIEDMANN
 SSI-FO-16
 160 mm



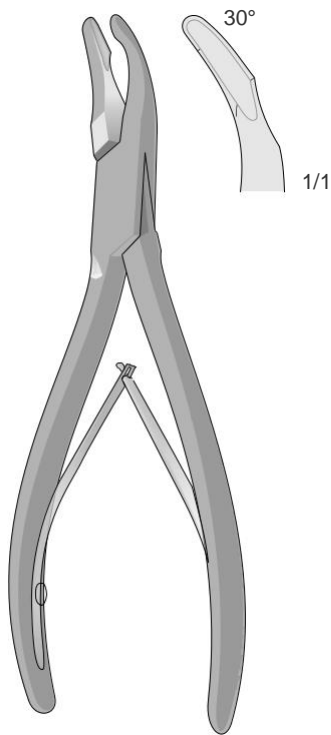
BEYER
 SSI-FO-20
 180 mm



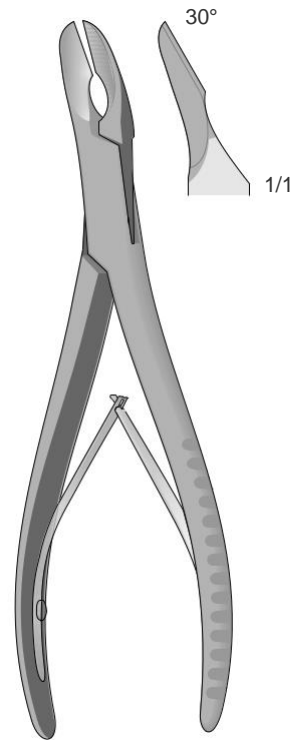
ZAUFAL-JANSEN
 SSI-FO-34
 180 mm

Email: sheffieldsurgicalinstruments@gmail.com
 Web: www.sheffieldsurgicalinst.com

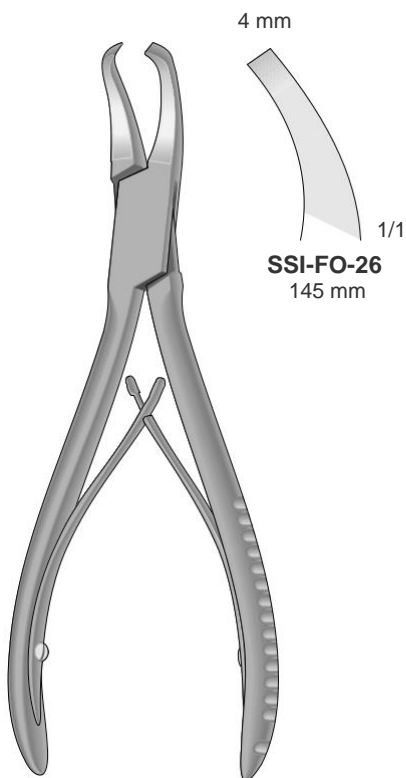
Hohlmeißelzangen
 Bone rongeurs
 Pinze ossivore
 Pinzas gubias
 Pincas gouges



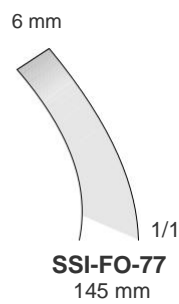
CLEVELAND
SSI-FO-231 140 mm
SSI-FO-232 170 mm



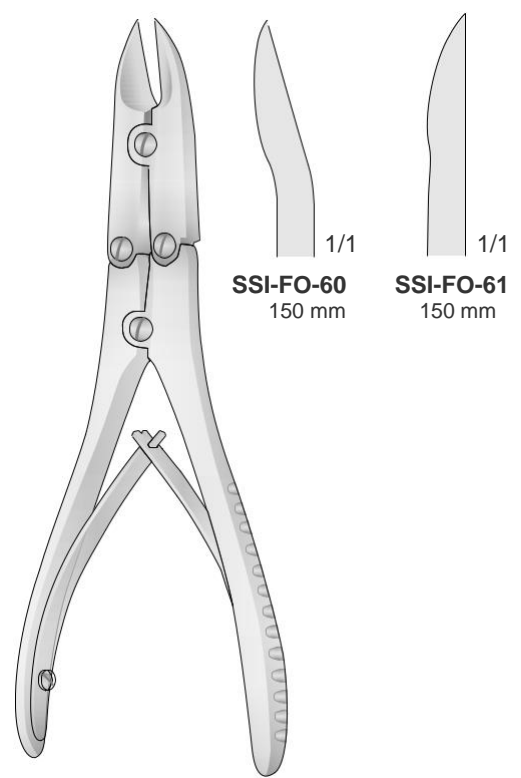
CLEVELAND
SSI-FO-233 150 mm
SSI-FO-234 170 mm



GARDNER
SSI-FO-26/SSI-FO-77
 145 mm



SSI-FO-77
 145 mm



BÖHLER
SSI-FO-60/SSI-FO-61
 150 mm

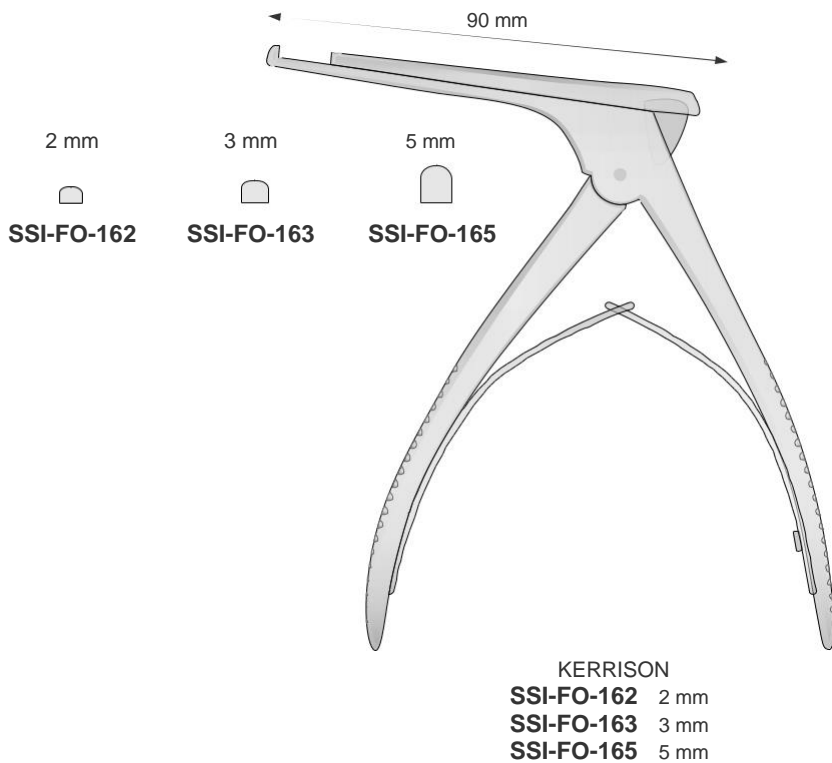
Email: sheffieldsurgicalinstruments@gmail.com
 Web: www.sheffieldsurgicalinst.com



Punches - Stanzen

Bone cutting forceps
for opening the Sinus
Strumento tagliente per
aumentare il volume del seno

Knochensplitterzangen
Bone cutting forceps
Pinze ossivore
Pinzas cortantes para huesos
Pincas coupantes à os



Bone cutting forceps
for opening the Sinus
Strumento tagliente per
aumentare il volume del seno

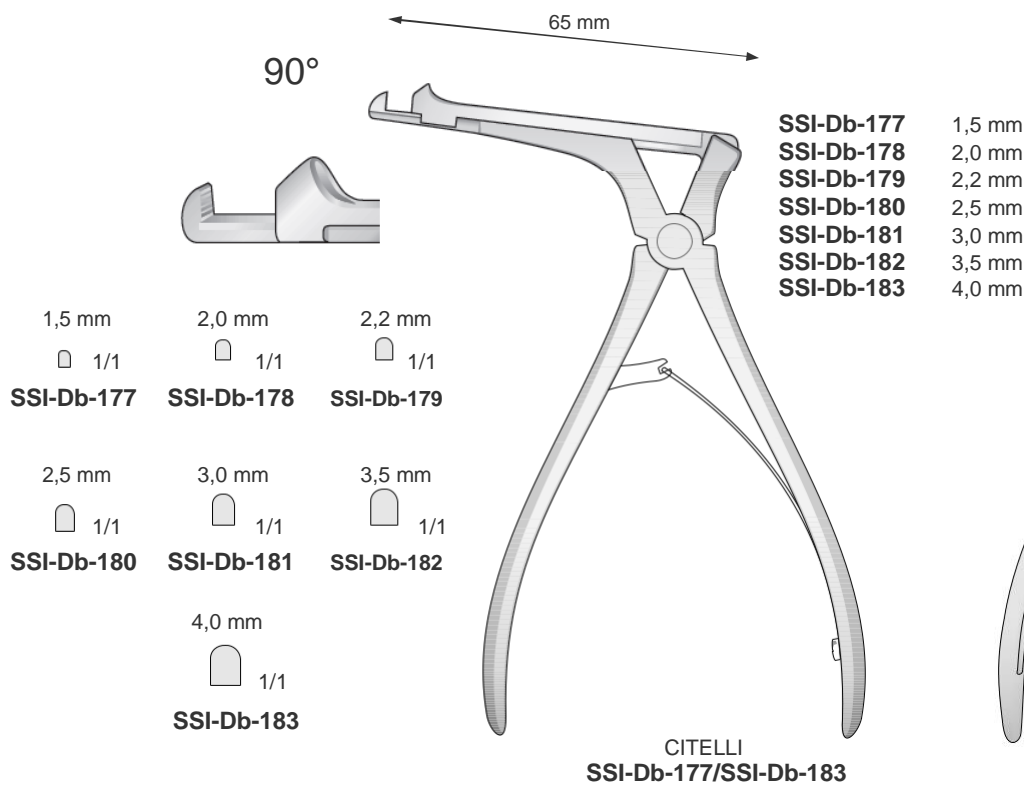
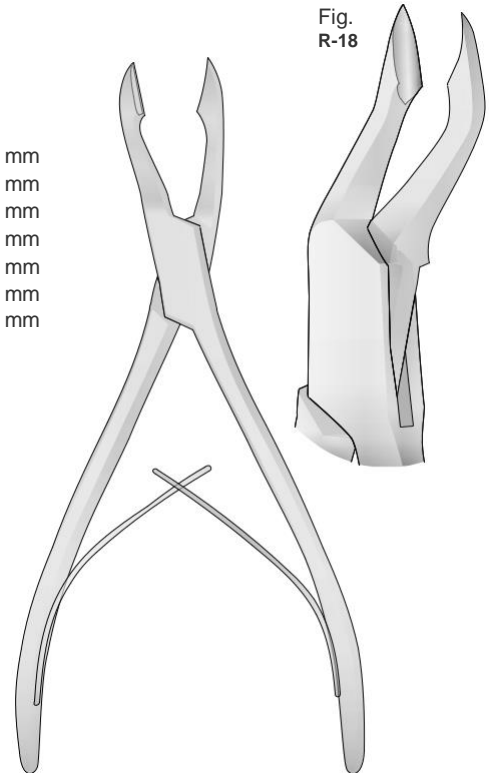


Fig.
R-18



Email: sheffieldsurgicalinstruments@gmail.com
Web: www.sheffieldsurgicalinst.com



Dental Restoration

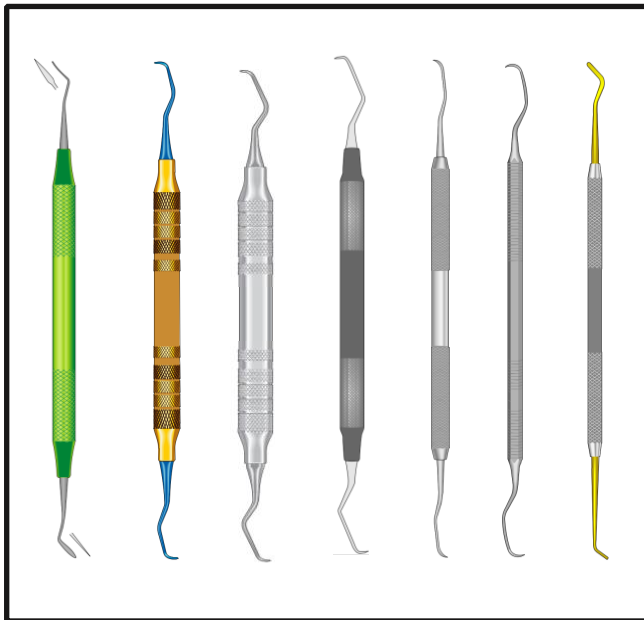
Restaurative Zahnheilkunde
Odontologie conservatrice
Odontología conservadora
Odontoiatria conservativa

Diagnosis

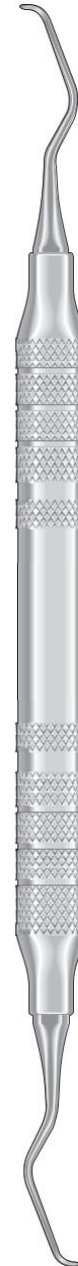
Diagnose
Diagnostic
Diagnóstico
Diagnosi

Periodontology

Parodontologie
Parodontie
Periodoncia
Parodontologia

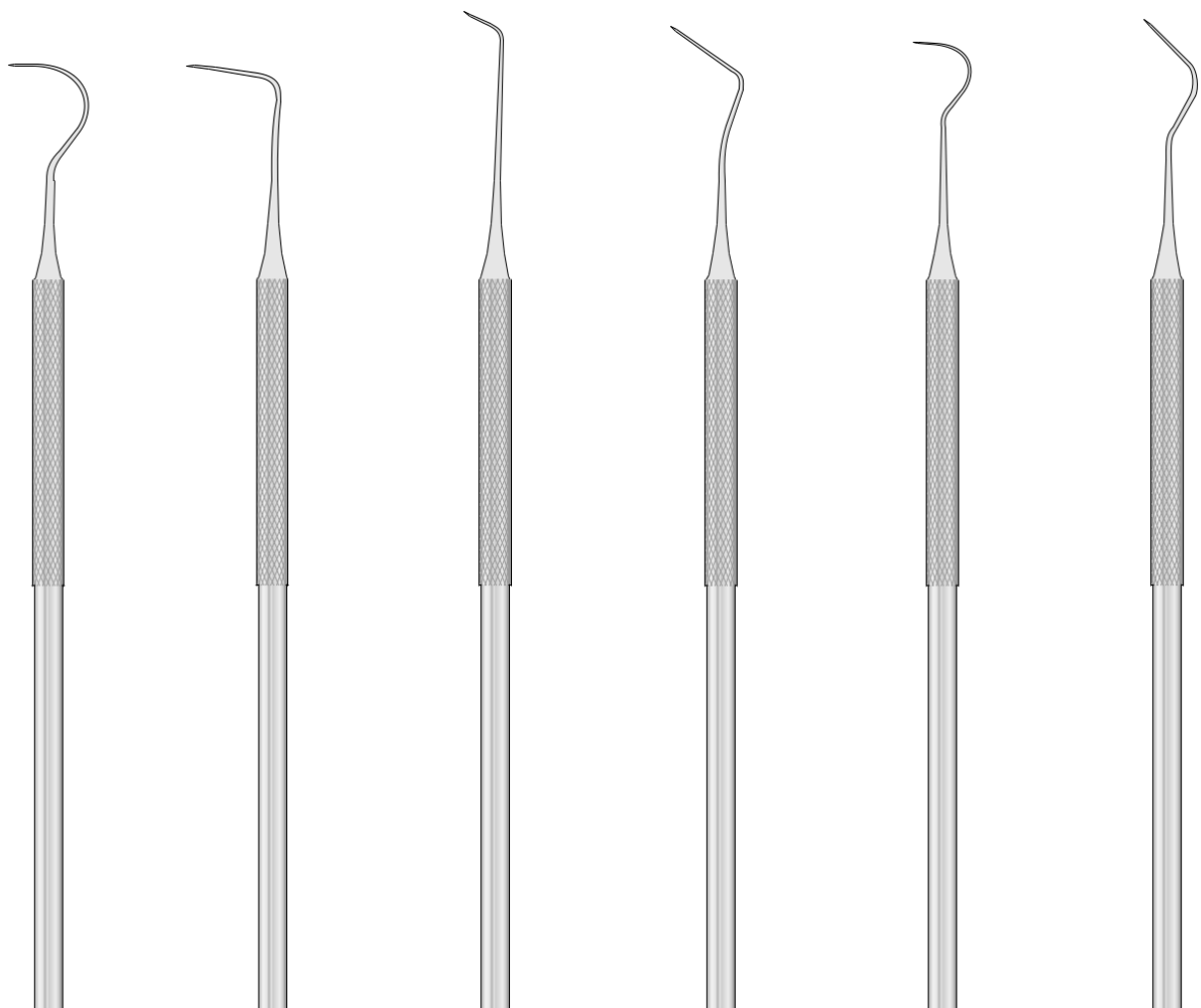


Sheffield Surgical is highly experienced Manufacturer & exporter of high quality Dental Instruments and also in the field of General Surgery, Bone Surgery an Orthopedic Instruments.



Email: sheffieldsurgicalinstruments@gmail.com
Web: www.sheffieldsurgicalinst.com

Zahnsonden
Explorers - Sickle Probes
Esploratori - Sonde falce
Sondas exploradoras
Sondes exploratrices



SSI-SO-1
Fig. 23

SSI-SO-2
Fig. 11

SSI-SO-3
Fig. 6

SSI-SO-4
Fig. 9

SSI-SO-5
Fig. 2

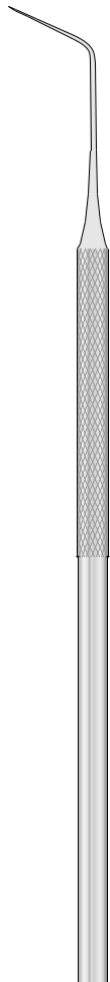
SSI-SO-6
Fig. 10



Zahnsonden
Explorers - Sickle Probes
Esploratori - Sonde falce
Sondas exploradoras
Sondes exploratrices



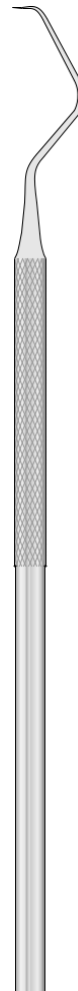
SSI-SO-7
Fig. 12



SSI-SO-8
Fig. 6A



SSI-SO-9
Fig. 8A



SSI-SO-10
Fig. 17A



SSI-SO-11
Fig. 3A

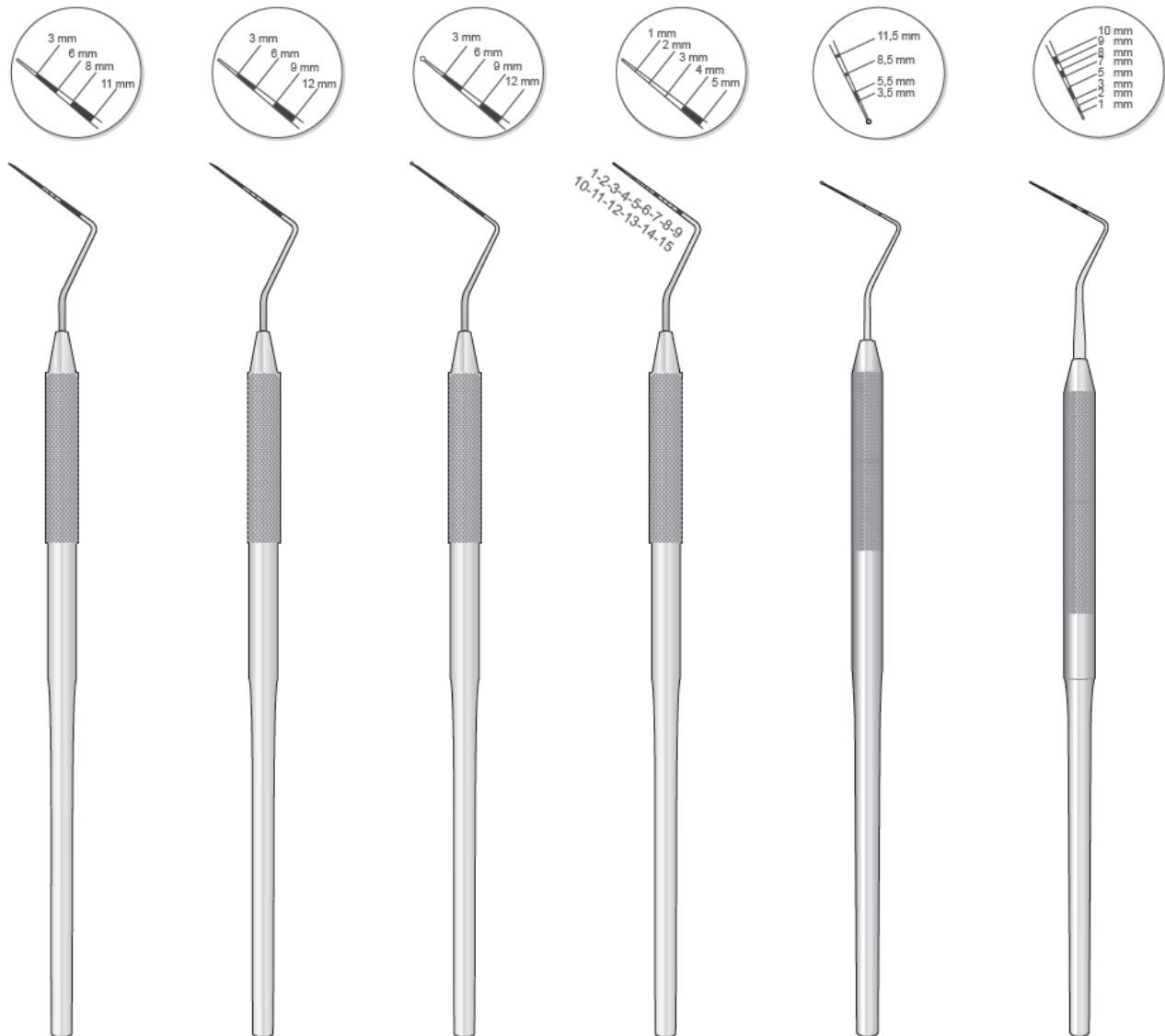


SSI-SO-12
Fig. 3

Email: sheffieldsurgicalinstruments@gmail.com
Web: www.sheffieldsurgicalinst.com

Parodontometer
 Periodontal Probes
 Sonde parodontali
 Sondas parodontales
 Sondes parodontales

Do not sterilizing with ultra sound - Not Metal brushes
 Non sterilizzare in ultrasuoni - No spazzola metallica



CSSI-P11
 SSI-SM-11
 160 mm

CSSI-P12
 SSI-SM-12
 160 mm

CSSI-P12S
 SSI-SM-13
 160 mm

1-2-3-4-5-6-7-8-9
 10-11-12-13-14-15

CSSI-P15UNC
 SSI-SM-15
 160 mm

WHO
 SSI-SM-21
 160 mm

CSSI-P10
 SSI-SM-19
 160 mm



Parodontometer
 Periodontal Probes
 Sonde parodontali
 Sondas parodontales
 Sondes parodontales

Double-ended Explorer
 Doppelendiger Zahnsonden
 Sonde esploratrice double
 Sonda exploradora doble
 Sonda falce doppia



11/12 ODU
SSI-SO-20
 165 mm



UT3/4 CATTONI
SSI-SM-20
 165 mm



2QN NABERS
SSI-SM-22
 175 mm



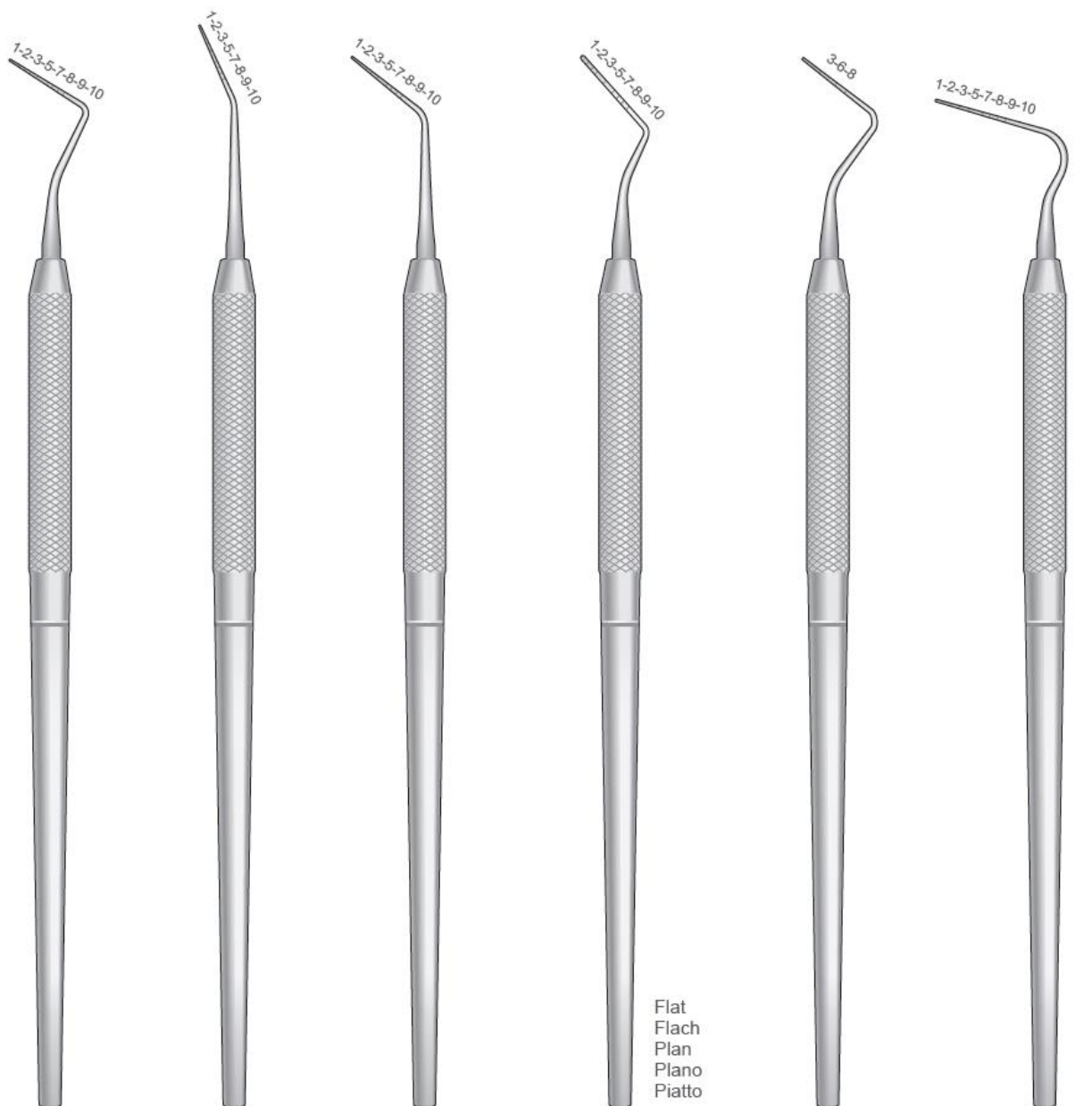
23 CSSI-P11
SSI-EX-11



23 CSSI-P12
SSI-EX-12

Email: sheffieldsurgicalinstruments@gmail.com
 Web: www.sheffieldsurgicalinst.com

Parodontometer
 Periodontal Probes
 Sonde parodontali
 Sondas parodontales
 Sondes parodontales



WILLIAMS
SSI-SM-1

MERRIT A
SSI-SM-2

MERRIT B
SSI-SM-3

GOLDMAN-FOX
SSI-SM-4

Flat
 Flach
 Plan
 Plano
 Piatto

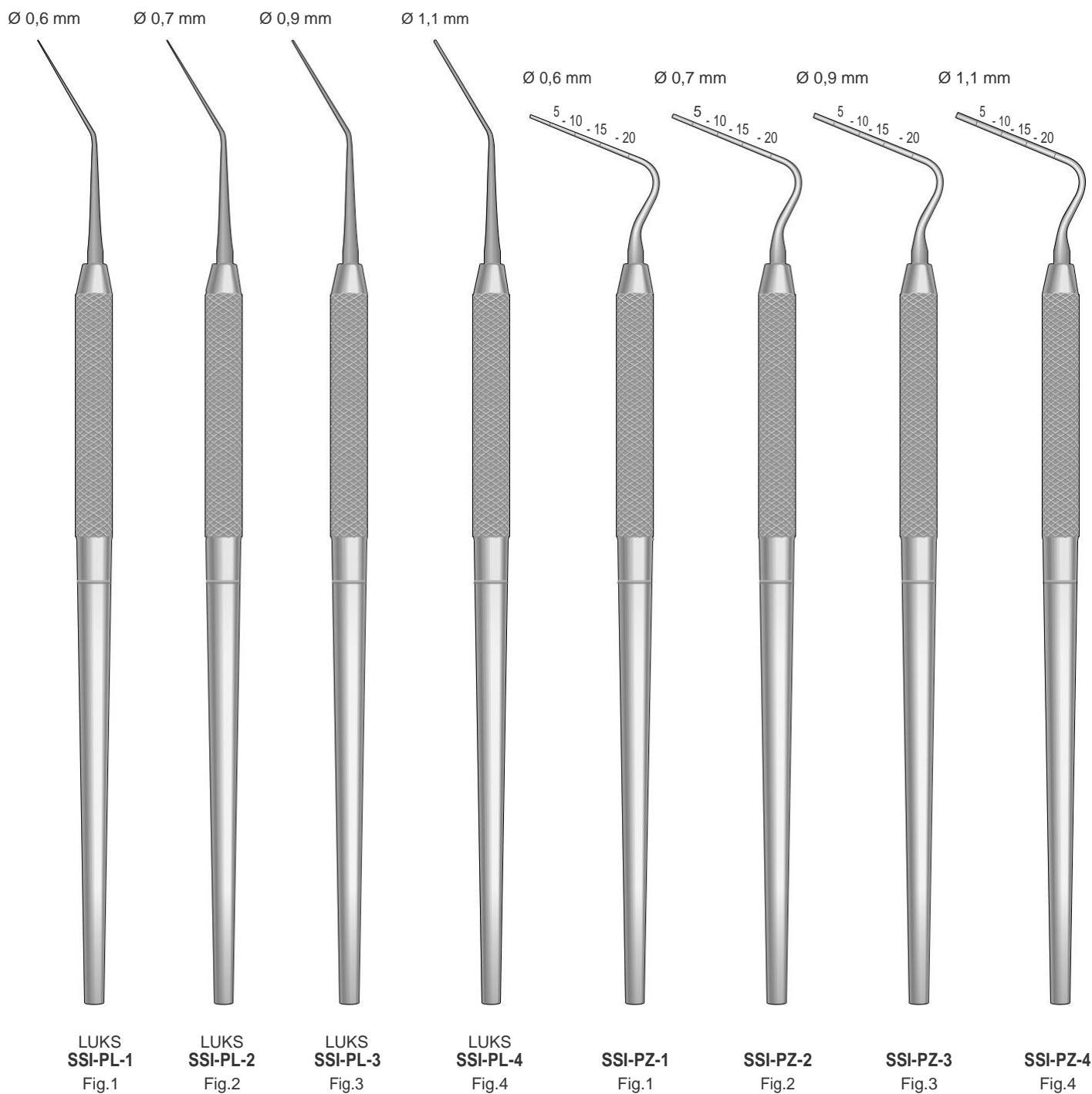
UNIVERSITY
OF MICHIGAN
SSI-SM-5

26 G
SSI-SM-6

Email: sheffieldsurgicalinstruments@gmail.com
 Web: www.sheffieldsurgicalinst.com



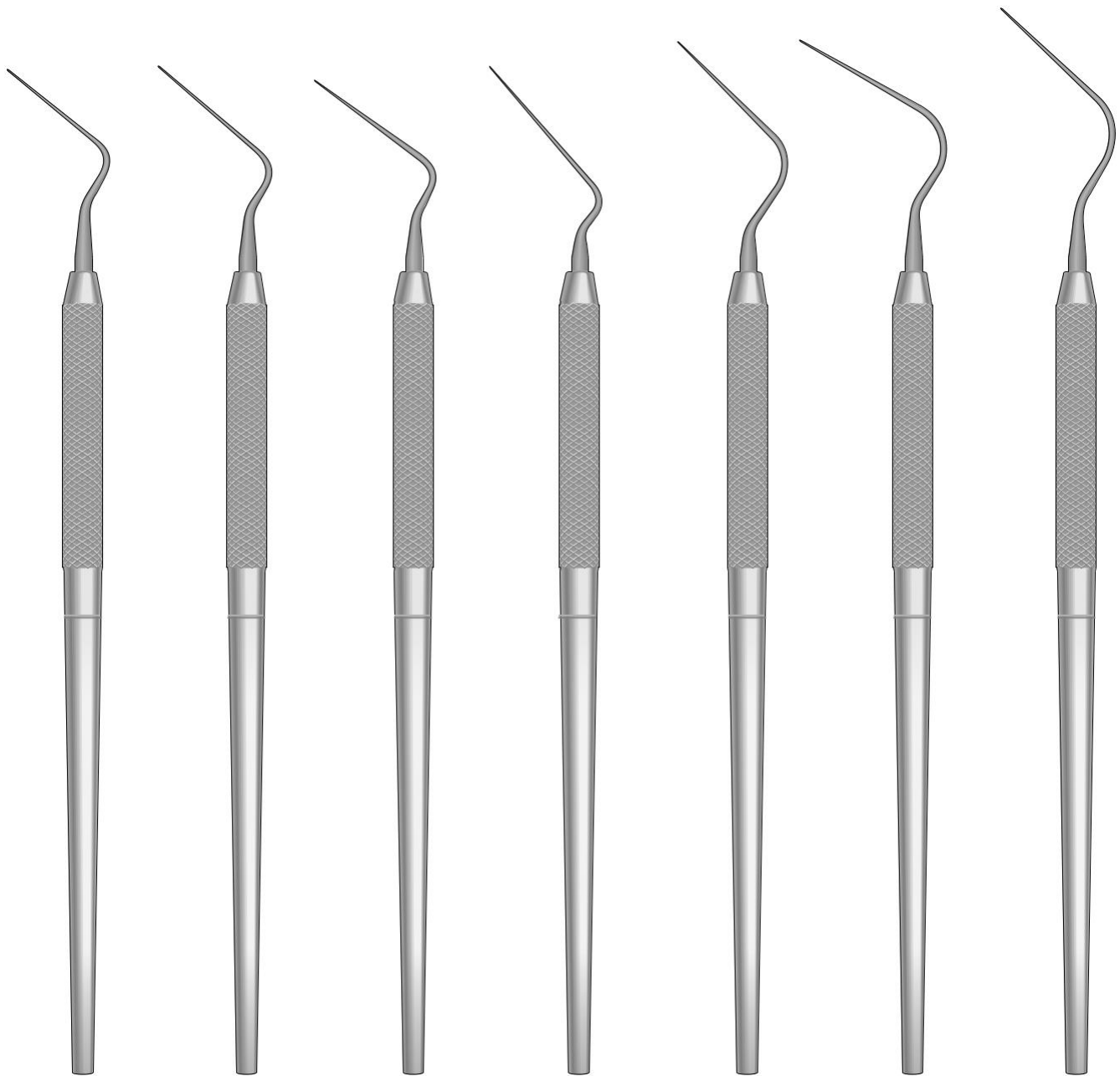
Instrumente für Endodontie
Endodontic Instruments
Strumenti per Endodonzia
Instrumentos para Endodoncia
Instruments pour Endodontie



Email: sheffieldsurgicalinstruments@gmail.com
Web: www.sheffieldsurgicalinst.com

Instrumente für Endodontie
Endodontic Instruments
Strumenti per Endodonzia
Instrumentos para Endodoncia
Instruments pour Endodontie

Spreaders



SSI-SSSI-P1
Fig.1S

SSI-SSSI-P2
Fig.2S

SSI-SSSI-P3
Fig.D11

SSI-SSSI-P4
Fig.MA57

SSI-SSSI-P5
Fig.0

SSI-SSSI-P6
Fig.00

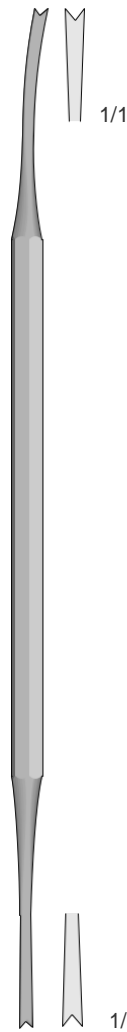
SSI-SSSI-P7
Fig.3

Email: sheffieldsurgicalinstruments@gmail.com
Web: www.sheffieldsurgicalinst.com



Watteträger
Cotton Applicators
Porta cotone
Portaalgodón
Applicateur de coton

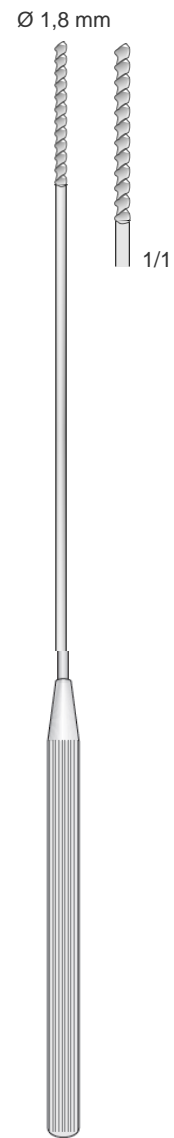
Tamponstopfer
Gauze Packers
Porta tamponi
Portatampones
Porte tampons



LUNIATSCHEK
SSI-PF-6
170 mm



UNIVERSAL
SSI-PF-40
140 mm



UNIVERSAL
SSI-PF-41
180 mm

Email: sheffieldsurgicalinstruments@gmail.com
Web: www.sheffieldsurgicalinst.com

Mundspiegel und Griffe
Mirrors and handles
Specchietti e manici
Espejos y mangos
Miroirs et manches

Rhodiumspiegel
Rhodium Mirror
Specchietto rodato
Espejo de rodio
Miroir au rhodium

Box of 12

| | | |
|---------------|--------------|----------------|
| SSI-P3 | # 3 - Ø 18mm | Flach Plane |
| SSI-P4 | # 4 - Ø 22mm | Piano |
| SSI-P5 | # 5 - Ø 24mm | Plano Plan |

Box of 12

| | | |
|-----------------|--------------|----------------|
| SSI-RH-4 | # 4 - Ø 22mm | Simple Stem |
| SSI-RH-5 | # 5 - Ø 24mm | |

| | |
|------------------|----------------|
| SSI-RH-4A | Cone Socket |
| SSI-RH-5A | |

Box of 12

| | | |
|----------------|--------------|---|
| SSI-G-3 | # 3 - Ø 18mm | Hohl-Vergrößernd Concave with enlarging effect |
| SSI-G-4 | # 4 - Ø 22mm | Concavo con ingrandimento |
| SSI-G-5 | # 5 - Ø 24mm | Còncavo con efecto de aumento Creux avec effect d'agrandissant |

Box of 6

| | |
|------------------|--------------|
| SSI-RH-14 | # 4 - Ø 22mm |
|------------------|--------------|

MEGA DUO
RHODIUM n.4

Beidseitig Rhodium Beschichtet
Both sides Rhodium-coated
Con rivestimento in rodio su entrambi i lati
Revestido con rodio en ambos lados
Revêtu de rhodium des deux côtés

Massiv - Solid
Pieno - Sólido - Solide

Hohl - Hollow
Vuoto - Hueco - Creux

SSI-MA-1
Simple Stem
120 mm

SSI-MA-1A
Cone Socket
120 mm

SSI-MA-2
Simple Stem
125 mm

SSI-MA-2A
Cone Socket
125 mm

inox
STAINLESS
STEEL

SSI-MA-3
125 mm

SSI-AL-MA5
120 mm

SSI-MA-7
135 mm

Cr
CHROMIUM

Al
ALUMINIUM

inox
STAINLESS
STEEL

3
18 mm
1/1

4
22 mm
1/1

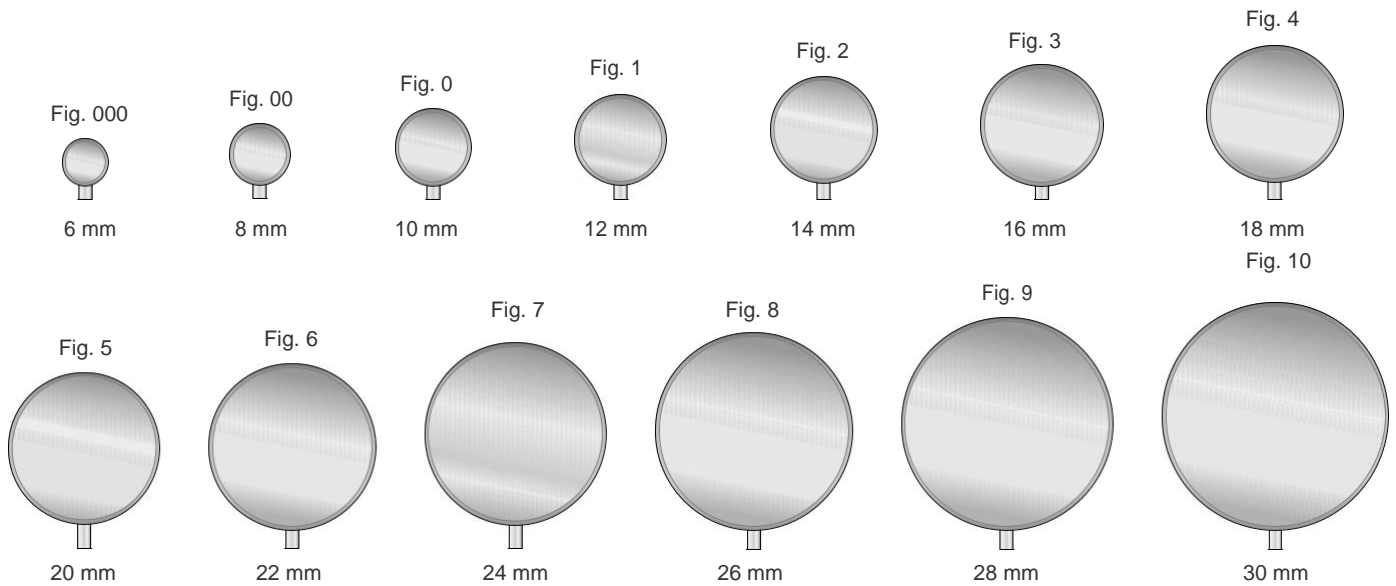
5
24 mm
1/1

Email: sheffieldsurgicalinstruments@gmail.com
Web: www.sheffieldsurgicalinst.com

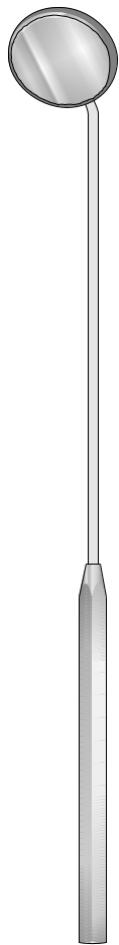


Mundspiegel und Griffe
Mirrors and handles
Specchietti e manici
Espejos y mangos
Miroirs et manches

Spiegeldurchmesser - Diameter of mirrors
Diametro dello specchio - Diamètre des miroirs
Diámetro de los espejos



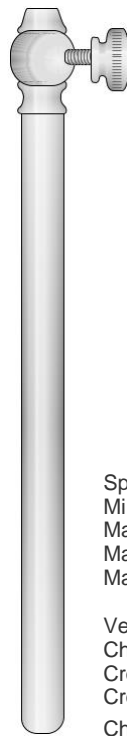
Inox



Kehlkopfspiegel mit
Sechskantgriff
Laryngeal mirrors
with hexagonal handle
Specchietto laringeo
con manico esagonale
Espejo laringeo
con mango hexagonal
Miroirs laryngiens
avec manche hexagonal

- SSI-G-8 Fig. 00
- SSI-G-10 Fig. 0
- SSI-G-12 Fig. 1
- SSI-G-14 Fig. 2
- SSI-G-16 Fig. 3
- SSI-G-18 Fig. 4
- SSI-G-20 Fig. 5
- SSI-G-22 Fig. 6
- SSI-G-24 Fig. 7
- SSI-G-26 Fig. 8
- SSI-G-28 Fig. 9
- SSI-G-30 Fig. 10

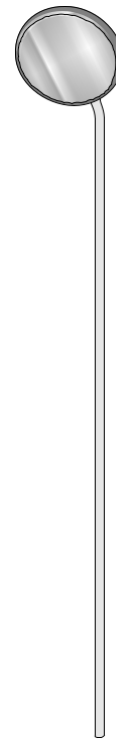
SSI-G-8/SSI-G-30
180 mm



Spiegelgriff
Mirrors handle
Manico per specchietti
Mango para espejos
Manche à miroir

Verchromt
Chromium
Cromato
Cromado
Chromé

SSI-MA-6
120 mm



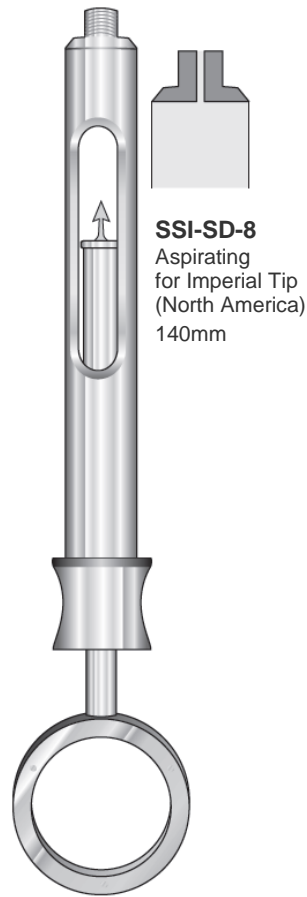
Kehlkopfspiegel
Laryngeal mirrors
Specchietto laringeo
Espejos laringeos
Miroirs laryngiens

- SSI-P000 Fig. 000
- SSI-P00 Fig. 00
- SSI-P0 Fig. 0
- SSI-P01 Fig. 1
- SSI-P02 Fig. 2
- SSI-P03 Fig. 3
- SSI-P04 Fig. 4
- SSI-P05 Fig. 5
- SSI-P06 Fig. 6

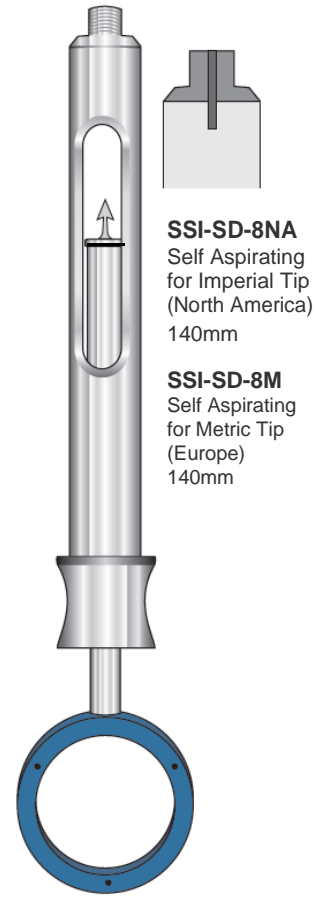
SSI-P000/SSI-P06
120 mm

Email: sheffieldsurgicalinstruments@gmail.com
Web: www.sheffieldsurgicalinst.com

Dental-Spritzen
Dental Syringes
Siringhe dentali
Jeringas dentales
Seringues dentaires



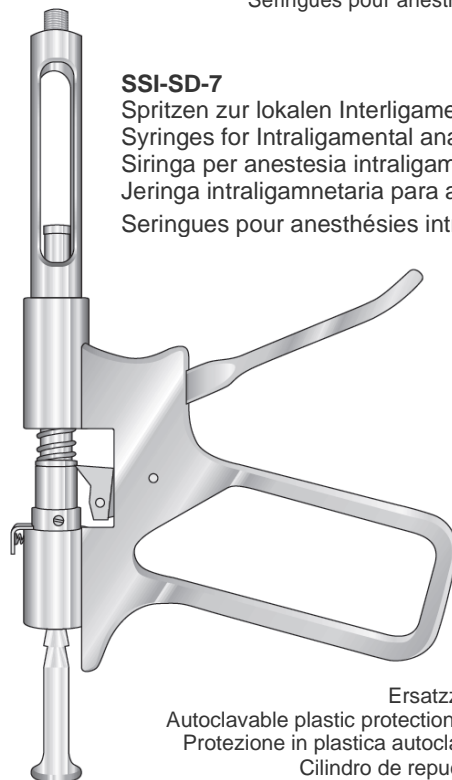
SSI-SD-8
Aspirating
for Imperial Tip
(North America)
140mm



SSI-SD-8NA
Self Aspirating
for Imperial Tip
(North America)
140mm

SSI-SD-8M
Self Aspirating
for Metric Tip
(Europe)
140mm

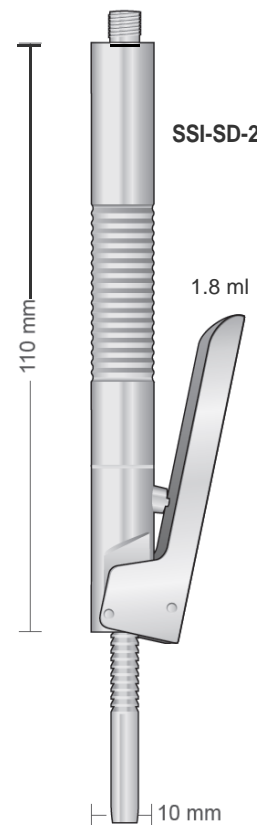
Spritzen zur lokalen Interligamentär-Anästhesie
Syringes for Intraligamental anaesthesia
Siringa per anestesia intraligamentare
Jeringa intraligamentaria para anestesia
Seringues pour anesthésies intraligementaires



SSI-SD-7
Spritzen zur lokalen Interligamentär-Anästhesie
Syringes for Intraligamental anaesthesia
Siringa per anestesia intraligamentare
Jeringa intraligamentaria para anestesia
Seringues pour anesthésies intraligementaires



SSI-SD-7R
Ersatzzylinder für SSI-SD-7
Autoclavable plastic protection sleeve for SSI-SD-7
Protezione in plastica autoclavabile per SSI-SD-7
Cilindro de repuesto para SSI-SD-7
Cylindre de rechange pour SSI-SD-7



SSI-SD-20

1.8 ml

110 mm

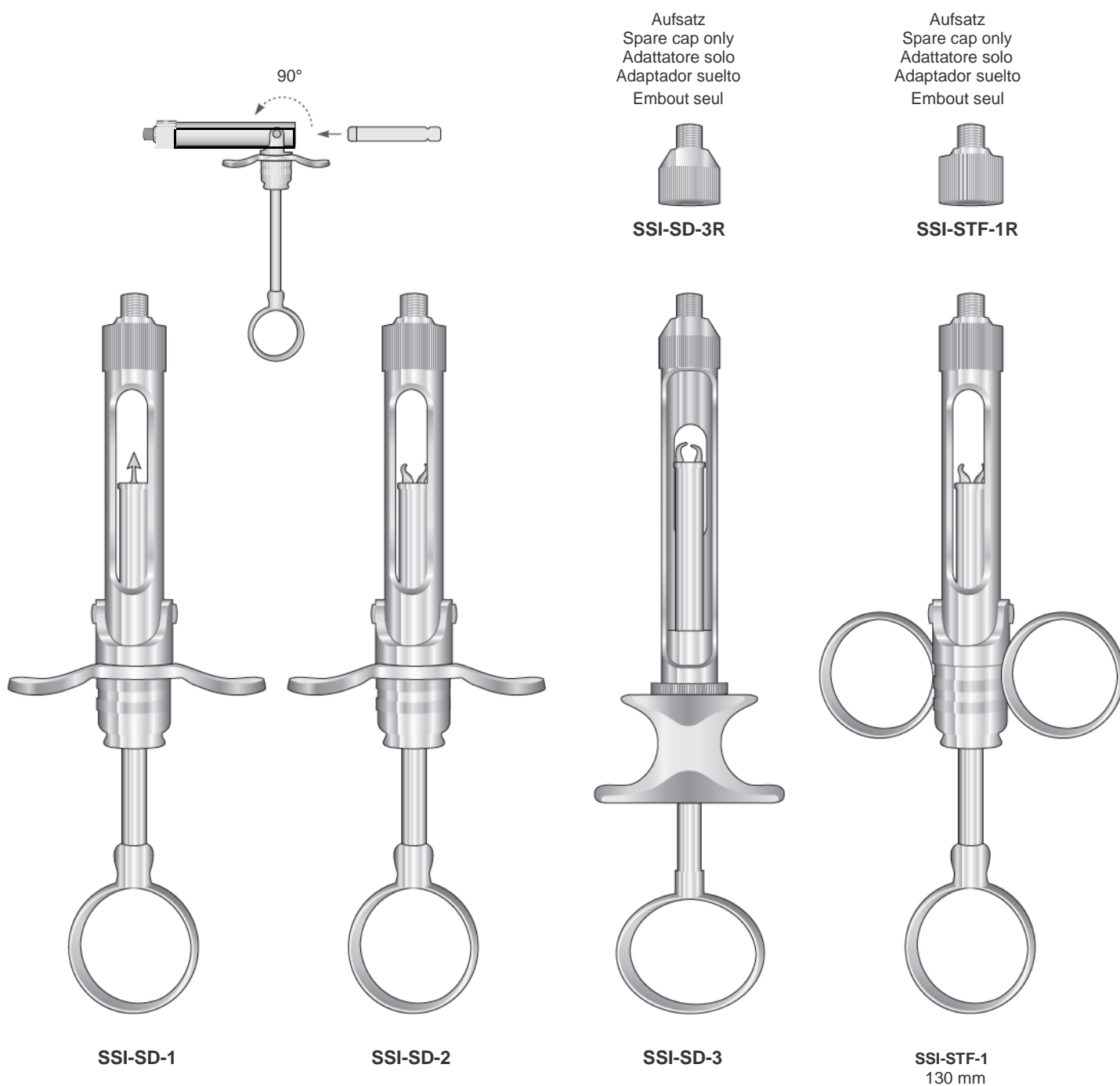
10 mm

Email: sheffieldsurgicalinstruments@gmail.com
Web: www.sheffieldsurgicalinst.com



Dental-Spritzen
Dental syringes
Siringhe dentali
Jeringas dentales
Seringues dentaires

Zylinder-Ampullen Spritzen
Cartridge Syringes
Siringhe per tubofiale
Jeringas de ampollas
Seringues d'ampoules

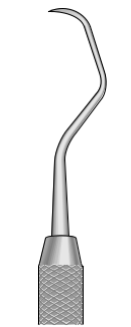


Email: sheffieldsurgicalinstruments@gmail.com
Web: www.sheffieldsurgicalinst.com

Küretten
Curettes
Curette
Curetas
Curettes



GRACEY
SSI-CU-1/2



GRACEY
SSI-CU-3/4



GRACEY
SSI-CU-5/6



GRACEY
SSI-CU-7/8



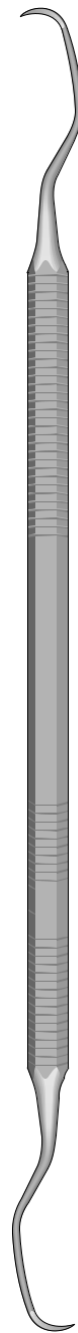
GRACEY
SSI-CU-9/10



GRACEY
SSI-CU-11/12



GRACEY
SSI-CU-13/14



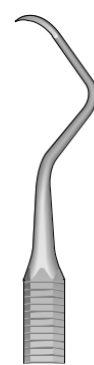
LANGER Fig.1/2
SSI-COL-1/2



LANGER Fig.3/4
SSI-COL-3/4



COLUMBIA
SSI-COL-2RL



COLUMBIA
SSI-COL-4RL



COLUMBIA
SSI-COL-13/14



Ø 9 mm

Hollow
Hohl
Creux
Hueco
Vuoto



Scaler und Küretten
Scalers and Curettes
Scaler e Curette
Raspadores y Curetas
Dértartreurs et Curettes



SSI-USG-1/2ET
Gracey
Curette 1/2ET



SSI-USG-3/4ET
Gracey
Curette 3/4ET



SSI-USG-5/6ET
Gracey
Curette 5/6ET



SSI-USG-7/8ET
Gracey
Curette 7/8ET



SSI-USG-9/10ET
Gracey
Curette 9/10ET



SSI-USG-11/12ET
Gracey
Curette 11/12ET



SSI-USG-13/14ET
Gracey
Curette 13/14ET



SSI-USG-15/16ET
Gracey
Curette 15/16ET

Email: sheffieldsurgicalinstruments@gmail.com
Web: www.sheffieldsurgicalinst.com



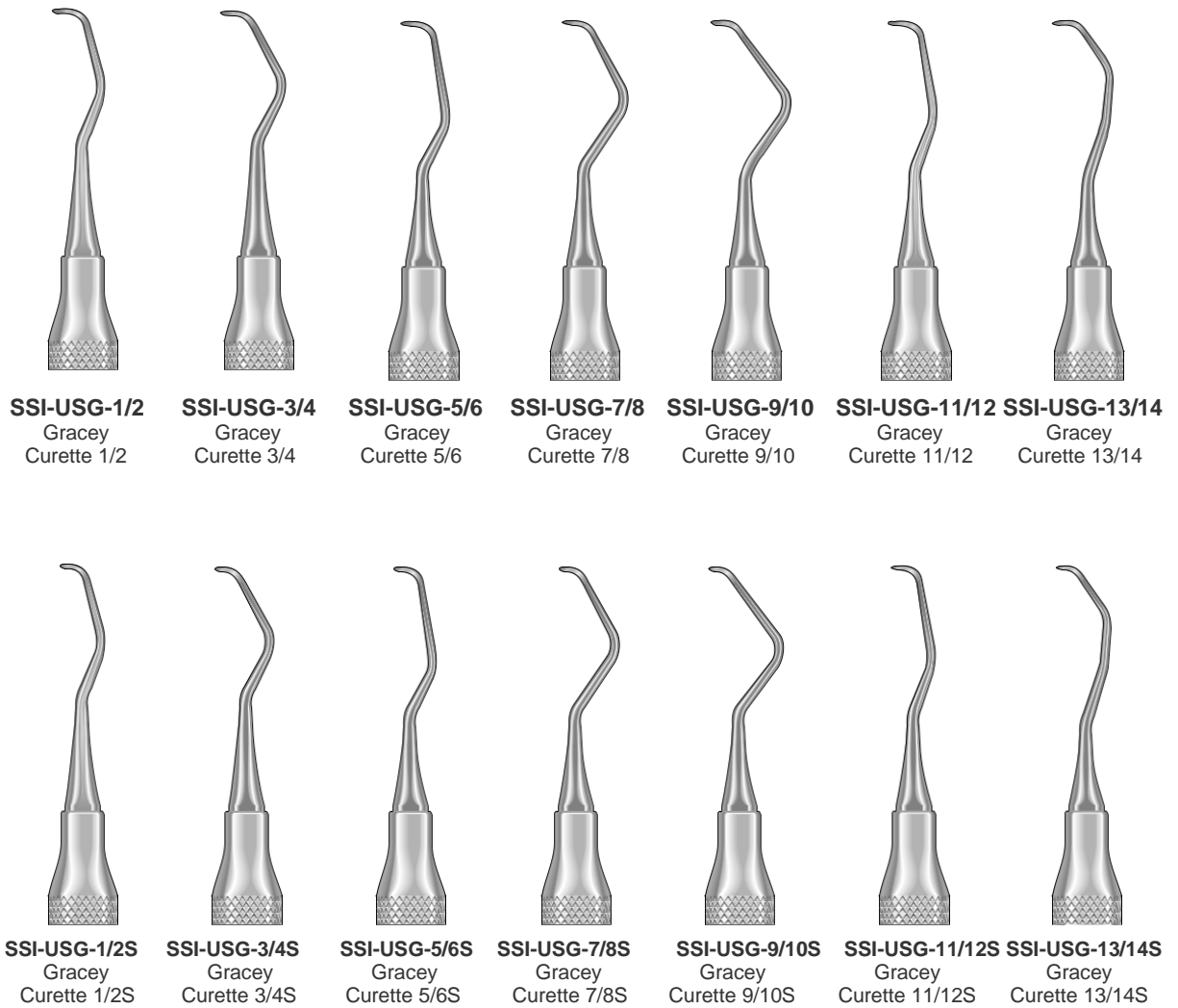
Scaler und Küretten
Scalers and Curettes
Scaler e Curette
Raspadores y Curetas
Détartreurs et Curettes



Hollow
Hohl
Creux
Hueco
Vuoto



Ø 9 mm



Email: sheffieldsurgicalinstruments@gmail.com
Web: www.sheffieldsurgicalinst.com



Hollow
Hohl
Creux
Hueco
Vuoto



Ø 9 mm

Scaler und Küretten
Scalers and Curettes
Scaler e Curette
Raspadores y Curetas
Détartreurs et Curettes



SSi-USG-1/2L
Gracey
Curette 1/2L



SSi-USG-3/4L
Gracey
Curette 3/4L



SSi-USG-5/6L
Gracey
Curette 5/6L



SSi-USG-7/8L
Gracey
Curette 7/8L



SSi-USG-9/10L
Gracey
Curette 9/10L



SSi-USG-11/12L
Gracey
Curette 11/12L



SSi-USG-13/14L
Gracey
Curette 13/14L



SSi-USG-15/16
Gracey
Curette 15/16



SSi-USG-17/18S
Gracey
Curette 17/18S



SSi-USS-KRA1
Kramer
Curette 1



SSi-USS-KRA3
Kramer
Curette 3



SSi-USG-KN1/26
Kramer-Nevins
Chisels 1/2



SSi-USS-MC11/12
McCall
Scaler 11/12



SSi-USS-MC13/14
McCall
Curette 13/14



SSi-USS-MC13/14S
McCall
Curette 13S/14S



SSi-USS-MC17/18S
McCall
Curette 17S/18S



SSi-USC-2RL
Columbia
Curette 2RL



SSi-USC-4RL
Columbia
Curette 4RL



SSi-USC-13/14
Columbia
Curette 13/14



SSi-USS-5/6LAN
Langer
Curette 5/6

Email: sheffieldsurgicalinstruments@gmail.com
Web: www.sheffieldsurgicalinst.com



Scaler und Küretten
Scalers and Curettes
Scaler e Curette
Raspadores y Curetas
Détartreurs et Curettes



Hollow
Hohl
Creux
Hueco
Vuoto



Ø 9 mm



SSI-USS-NV0
Scaler
NV0



SSI-USS-NV11/12
Scaler
NV11/12



SSI-USS-NV13/14
Scaler
NV13/14



SSI-USS-T2/3
Taylor
Scaler 2/3



SSI-USS-204S
Scaler
204S



SSI-USS-H6/7
Towner
Scaler
H6/H7



SSI-USS-15/33
Towner
Scaler
U15/J33



SSI-USS-5/33
Towner
Scaler
H5/J33



SSI-USS-15/30
Towner
Scaler
U15/J30



SSI-USS-J14/15
Jaquette
Scaler
J14/15



Email: sheffieldsurgicalinstruments@gmail.com
Web: www.sheffieldsurgicalinst.com



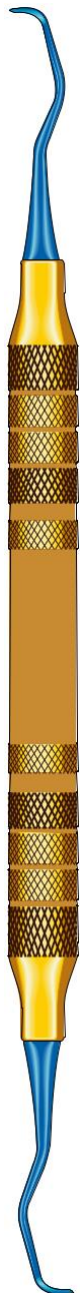
Hollow
Hohl
Creux
Hueco
Vuoto



Ø 98 mm

Elite Titanium
Scaler und Küretten
Scalers and Curettes
Scaler e Curette
Raspadores y Curetas
Détartreurs et Curettes

Designed for removing calculus on implants surfaces. Gold coloured handle with a titanium coating for easy identification purposes so they won't be mixed up with standard stainless instruments.



SSI-T-USG-1/2
Gracey
Curette 1/2



SSI-T-USG-5/6
Gracey
Curette 5/6



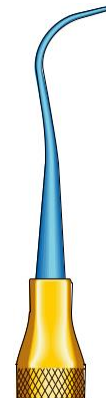
SSI-T-USG-7/8
Gracey
Curette 7/8



SSI-T-USG-11/12
Gracey
Curette 11/12



SSI-T-USG-13/14
Gracey
Curette 13/14



SSI-T-USS-YG7/8
Younger-Good
Curette YG 7/8



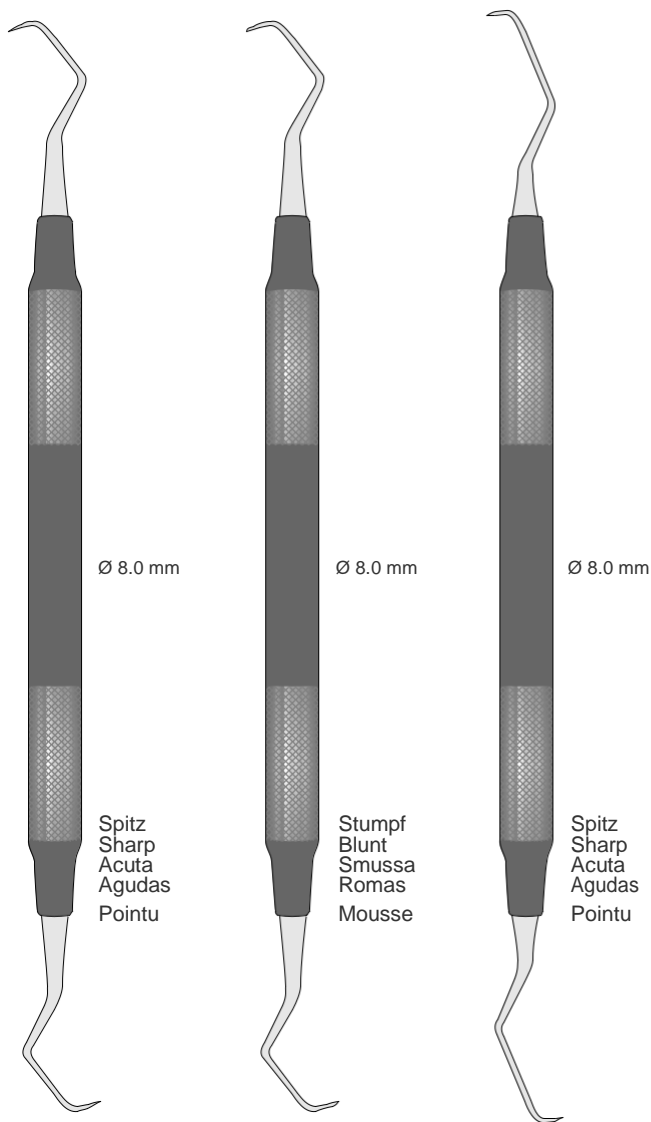
SSI-T-USS-B5/6
Barnhart
Curette 5/6

Email: sheffieldsurgicalinstruments@gmail.com
Web: www.sheffieldsurgicalinst.com

Küretten - Feilen
 Curettes - Files
 Curette - Lime
 Curetasc - Lima
 Curettes - Limes

Universal Küretten
 Universal Curettes
 Curette universali
 Curetas universales
 Curettes universelles

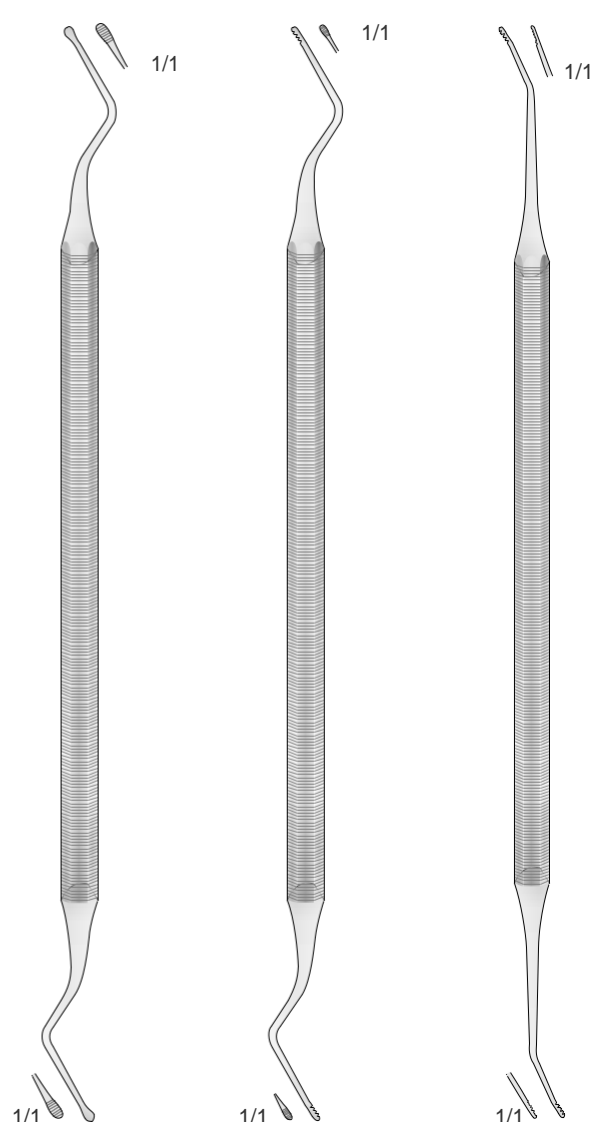
Parodontalfeilen
 Periodontal Files
 Lime parodontali
 Limas parodontales
 Limes parodontales



SSI-718-M23
165 mm

SSI-718-M23A
165 mm

SSI-718-M23B
170 mm



HIRSCHFELD SSI-HF-3/7
170 mm

HIRSCHFELD SSI-HF-5/11
170 mm

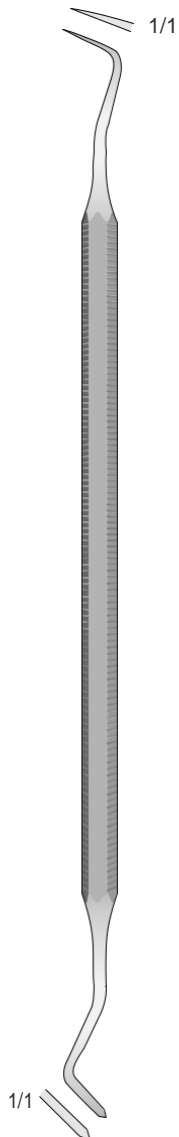
HIRSCHFELD SSI-HF-9/10
175 mm

Email: sheffieldsurgicalinstruments@gmail.com
 Web: www.sheffieldsurgicalinst.com

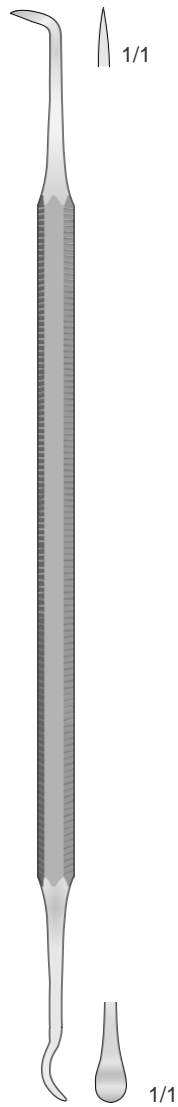


Scaler
Scalers
Ablatori di tartaro
Limpiadores
Détartreurs

Scalers



LANGE
SSI-PF-9
160 mm



MITCHEL
SSI-AT-12
170 mm



SSI-AT-1



SSI-AT-2R



SSI-AT-2L



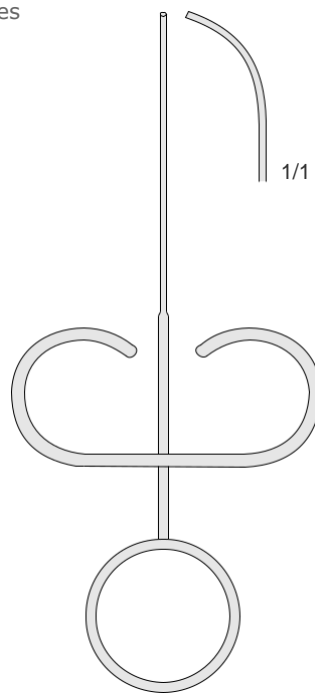
SSI-AT-6

Email: sheffieldsurgicalinstruments@gmail.com
Web: www.sheffieldsurgicalinst.com

Amalgampistole für retrograde
 Amalgam gun for retrograde
 Siringhe portamalgame retrogradi
 Portaamalgame para retrógradas
 Porte-amalgame pour rétrogrades

Nach oben Gebogen - Curved up
 Curva in avanti - Curvas hacia arriba
 Courbes vers le haut

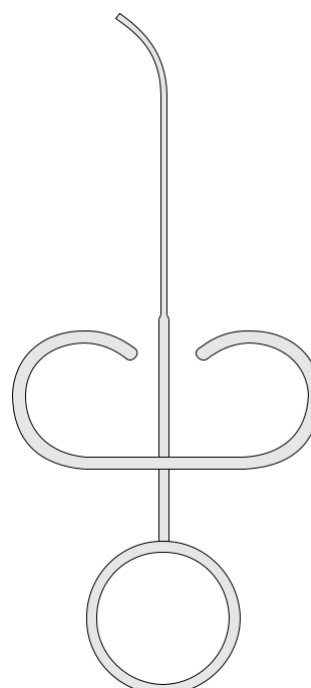
Ø 0,9 mm



SSI-SS-51
 130 mm

Seitwärts Gebogen - Curved to side
 Curva sul lato - Curvas laterales
 Courbes latérales

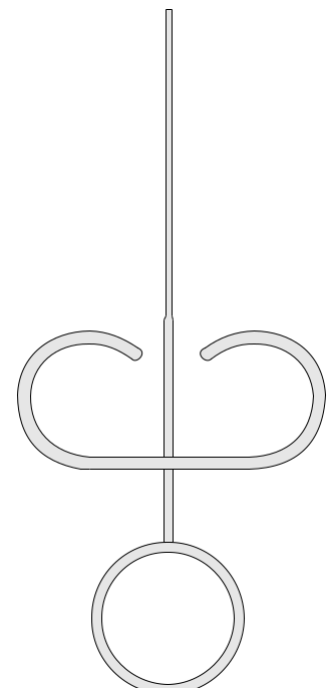
Ø 0,9 mm



SSI-SS-55
 130 mm

Gerade - Straight
 Diritta - Rectas
 Droites

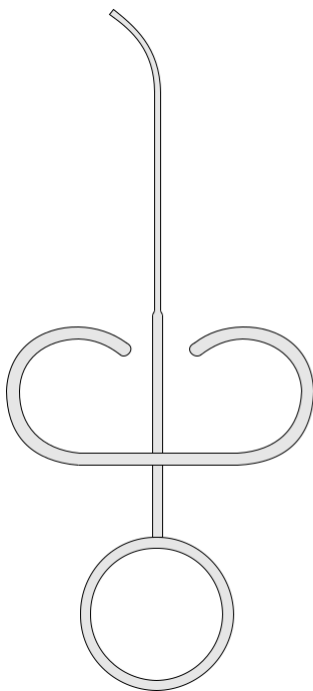
Ø 1,2 mm



SSI-SS-54
 130 mm

Seitwärts Gebogen - Curved to side
 Curva sul lato - Curvas laterales
 Courbes latérales

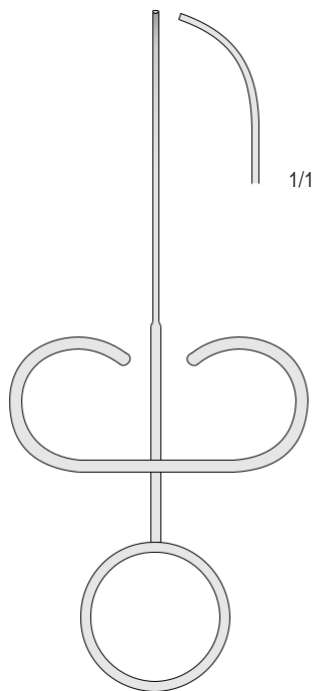
Ø 1,2 mm



SSI-SS-56
 130 mm

Nach oben Gebogen - Curved up
 Curva in avanti - Curva hacia arriba
 Courbes vers le haut

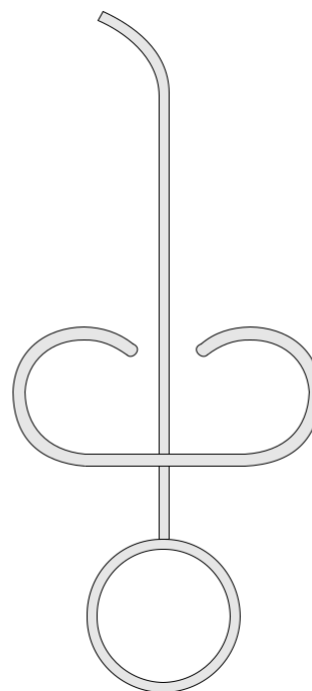
Ø 1,2 mm



SSI-SS-58
 130 mm

Seitwärts Gebogen - Curved to side
 Curva sul lato - Curvas laterales
 Courbes latérales

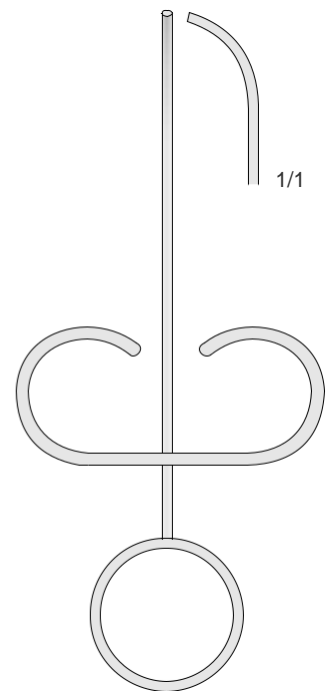
Ø 1,8 mm



SSI-SS-50
 130 mm

Nach oben Gebogen - Curved up
 Curva in avanti - Curvas hacia arriba
 Courbes vers le haut

Ø 1,8 mm



SSI-SS-52
 130 mm

Amalgambecher
 Amalgam Well
 Mortaio per amalgama
 Vaso para amalgama
 Gobelet pour amalgame

Amalgamträger
 Amalgam Carriers
 Porta amalgama
 Porta-amalgamas
 Porte-amalgames

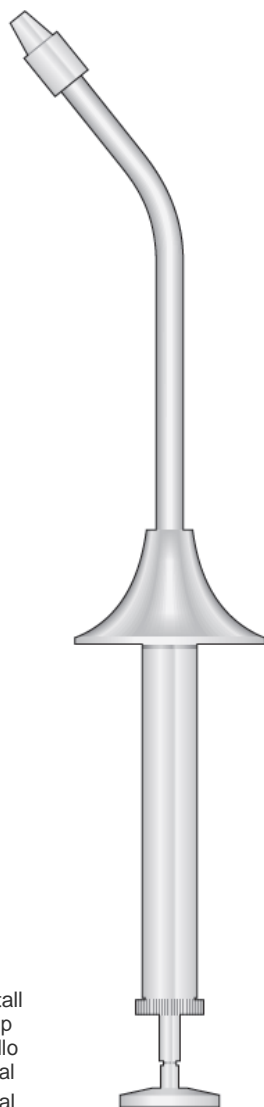


SSI-SS-65
 Ø 35 mm
 h. 35 mm

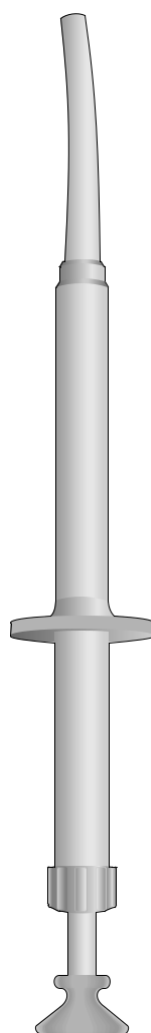


SSI-SS-15

Aus Metall
 Metal tip
 In metallo
 De metal
 En métal

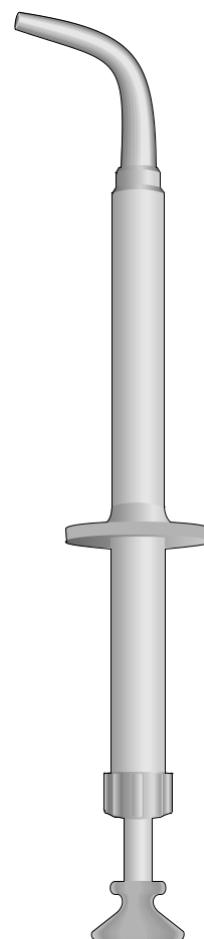


SSI-SS-16



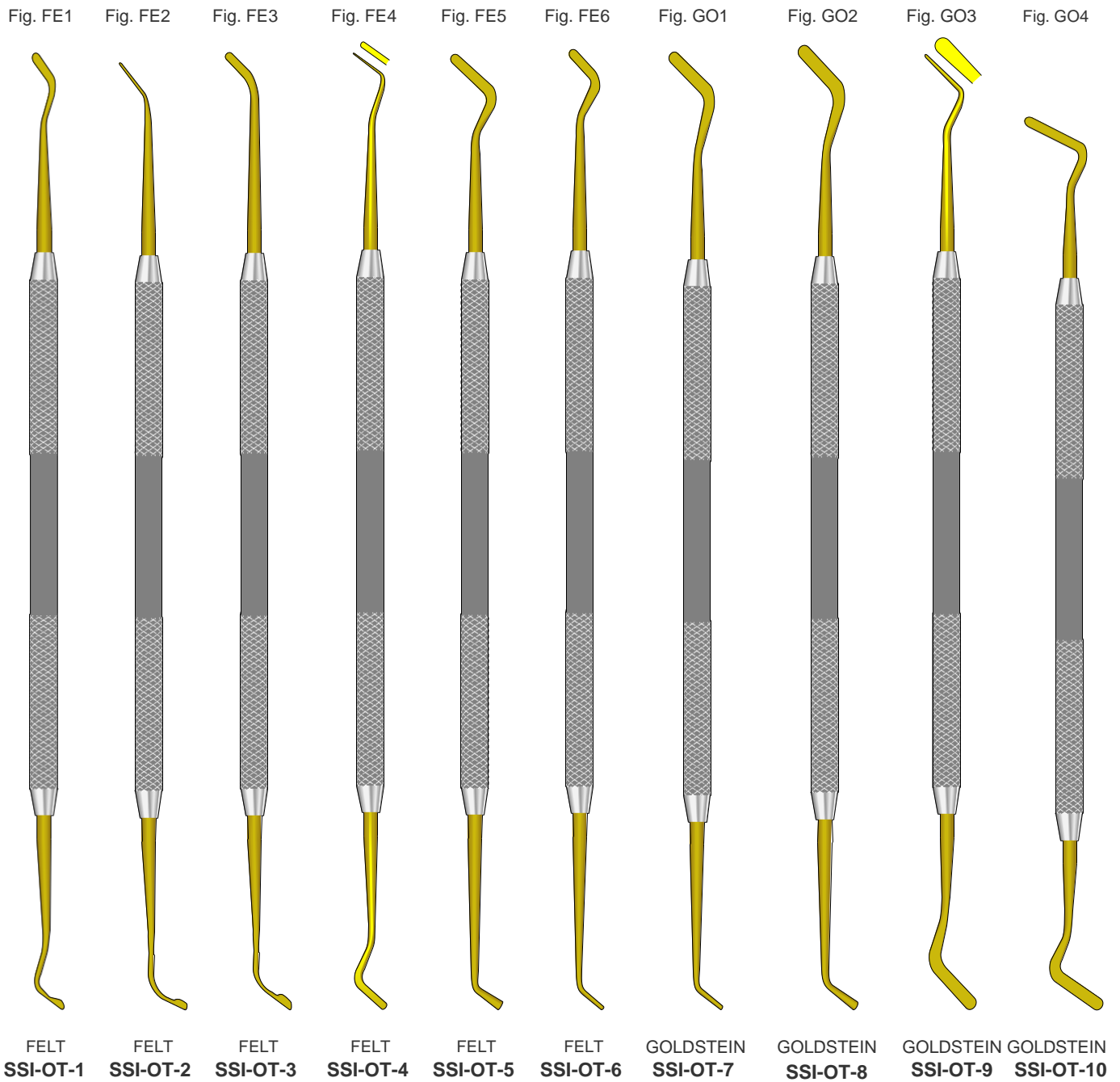
SSI-SS-41
 170 mm

Autoclavable
 Aus Kunststoff
 Plastic tip
 In plastica
 De plàstic
 En plàstique



SSI-SS-42
 160 mm

Kompositinstrumente
 Composite Instruments
 Strumenti per composito
 Instrumentos para composites
 Instruments pour composites



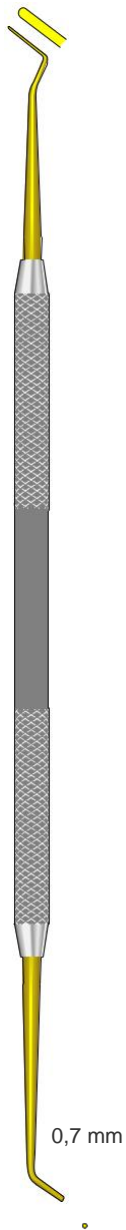
Email: sheffieldsurgicalinstruments@gmail.com
 Web: www.sheffieldsurgicalinst.com



Kompositinstrumente
Composite Instruments
Strumenti per composito
Instrumentos para composites
Instruments pour composites

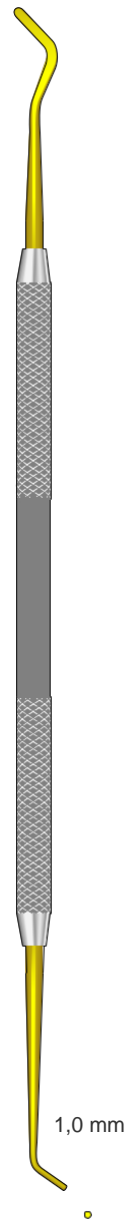


Fig. CP1
1,5 mm



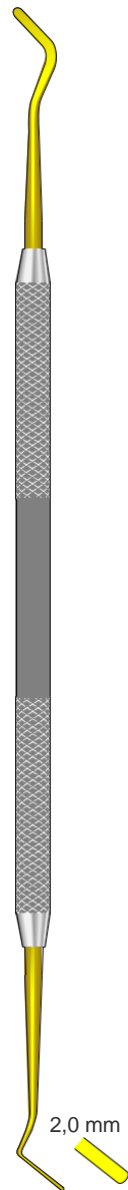
SSI-OT-11

Fig. CP2
2,0 mm



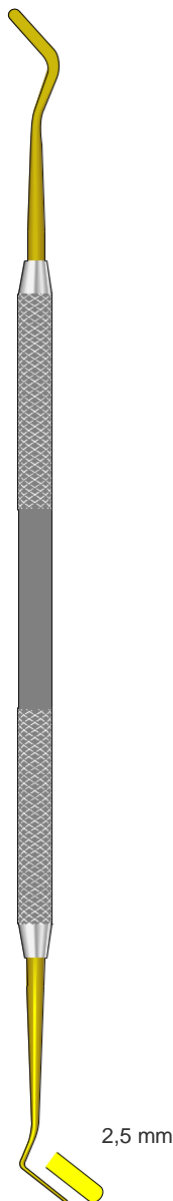
SSI-OT-12

Fig. CP3
2,0 mm



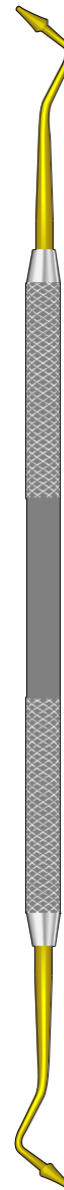
SSI-OT-13

Fig. CP4
2,5 mm



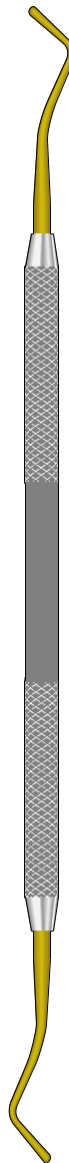
SSI-OT-14

Fig. CP5



SSI-OT-15

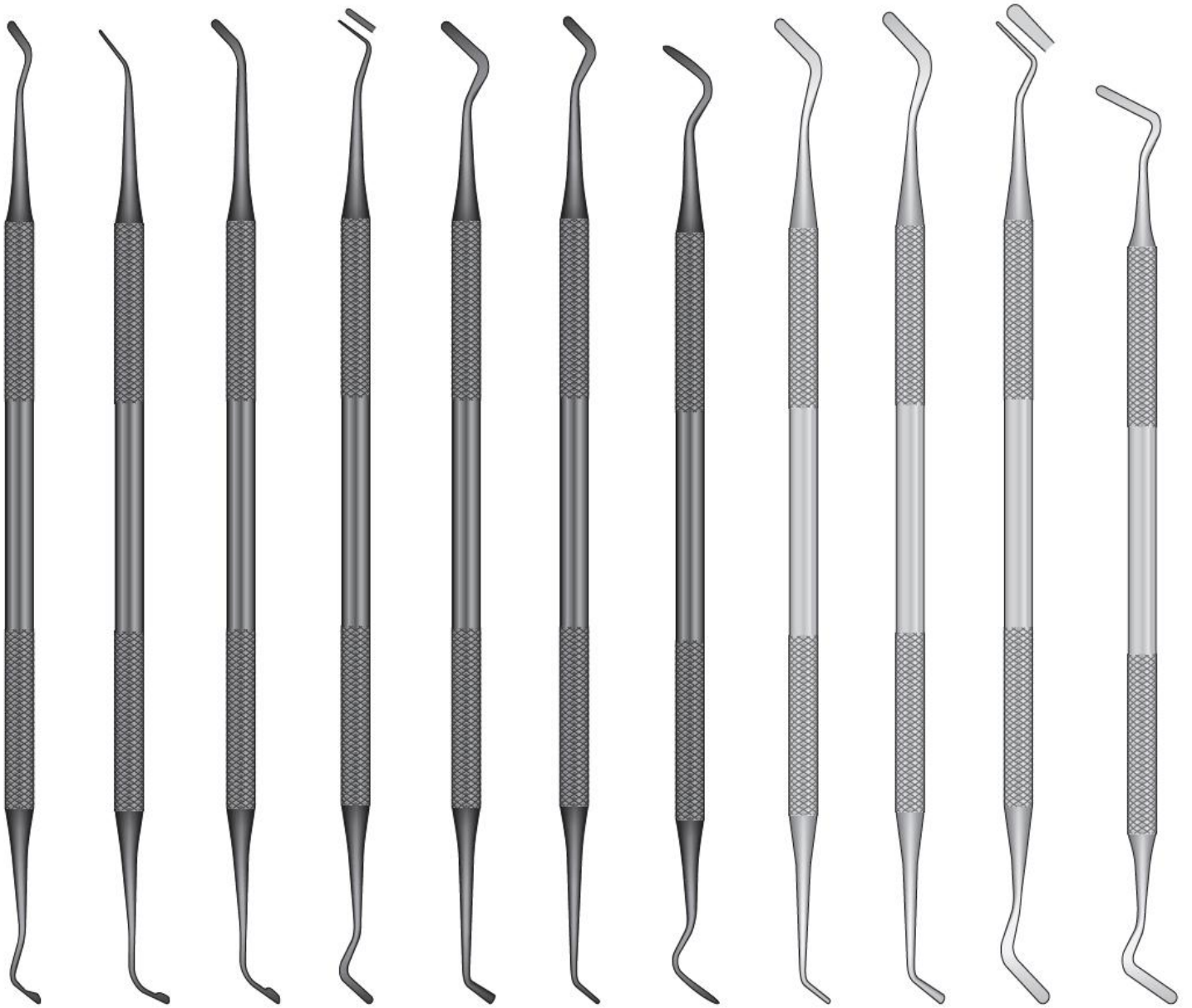
Fig. CP6



SSI-OT-16

Email: sheffieldsurgicalinstruments@gmail.com
Web: www.sheffieldsurgicalinst.com

Kompositinstrumente
 Composite Instruments
 Strumenti per composito
 Instrumentos para composites
 Instruments pour composites

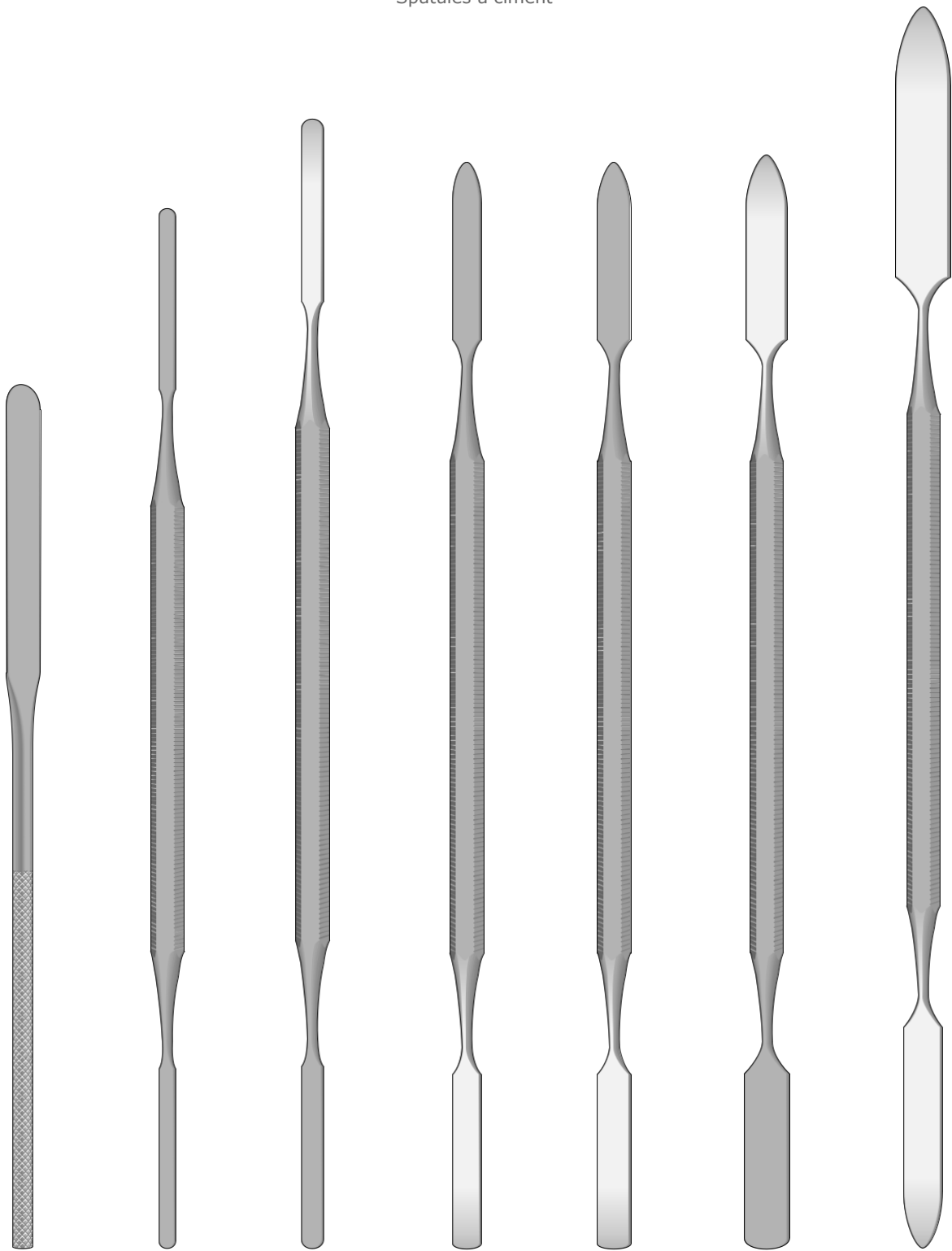


FELT SSI-FE-1 FELT SSI-FE-2 FELT SSI-FE-3 FELT SSI-FE-4 FELT SSI-FE-5 FELT SSI-FE-6 FELT SSI-FE-4/5 GOLDSTEIN SSI-GO-1 GOLDSTEIN SSI-GO-2 GOLDSTEIN SSI-GO-3 GOLDSTEIN SSI-GO-4

Email: sheffieldsurgicalinstruments@gmail.com
 Web: www.sheffieldsurgicalinst.com



Zementspatel
Cement Spatulas
Spatole per cemento
Espátulas para cemento
Spatules à ciment



SSI-SR
140 mm

SSI-S-00
180 mm

SSI-S-0
185 mm

SSI-S-1
180 mm

SSI-S-2
180 mm

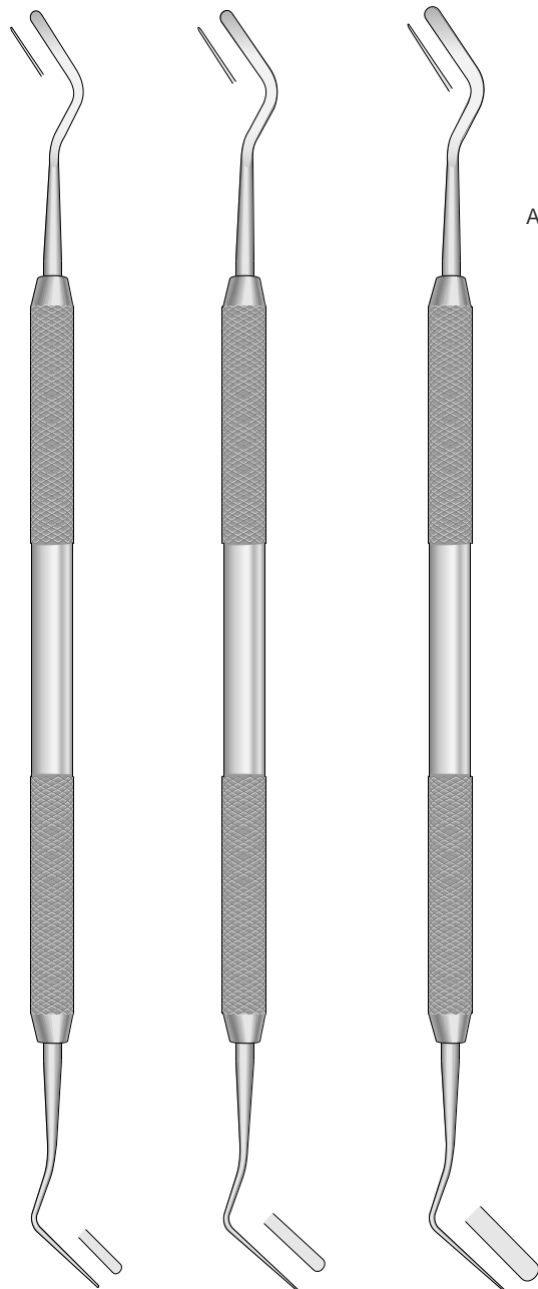
SSI-S-3
180 mm

SSI-S-4
20 mm

Email: sheffieldsurgicalinstruments@gmail.com
Web: www.sheffieldsurgicalinst.com

Füllungsinstrumente
 Filling Instruments
 Strumenti per otturazione
 Instrumentos para obturación
 Instruments pour obturation

Heidemann-Spateln
 Heidemann Spatulas
 Spatole Heidemann
 Espátulas Heidemann
 Spatules Heidemann



SSI-H-1
Fig. 1

SSI-H-2
Fig. 2

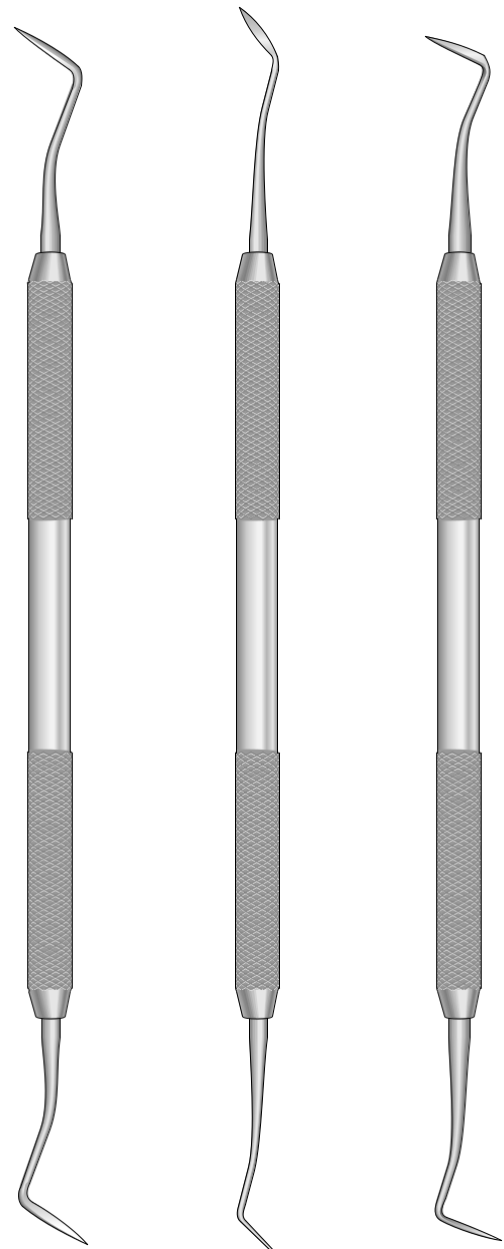
SSI-H-3
Fig. 3

Dycal Applikator
 Placement Instrument
 Applicatore per sottofondo
 Aplicadores de fondo
 de cavidades
 Applicateur de fond
 de cavité



SSI-A-1
125 mm

Amalgam Instrumente
 Amalgam Carvers
 Strumenti per modellare l'amalgama
 Instrumentos para modelar las obturaciones
 Instruments à modeler l'amalgame



SSI-R-1
HOLLENBACH
1 - 165 mm

SSI-R-2
HOLLENBACH
1/2 - 165 mm

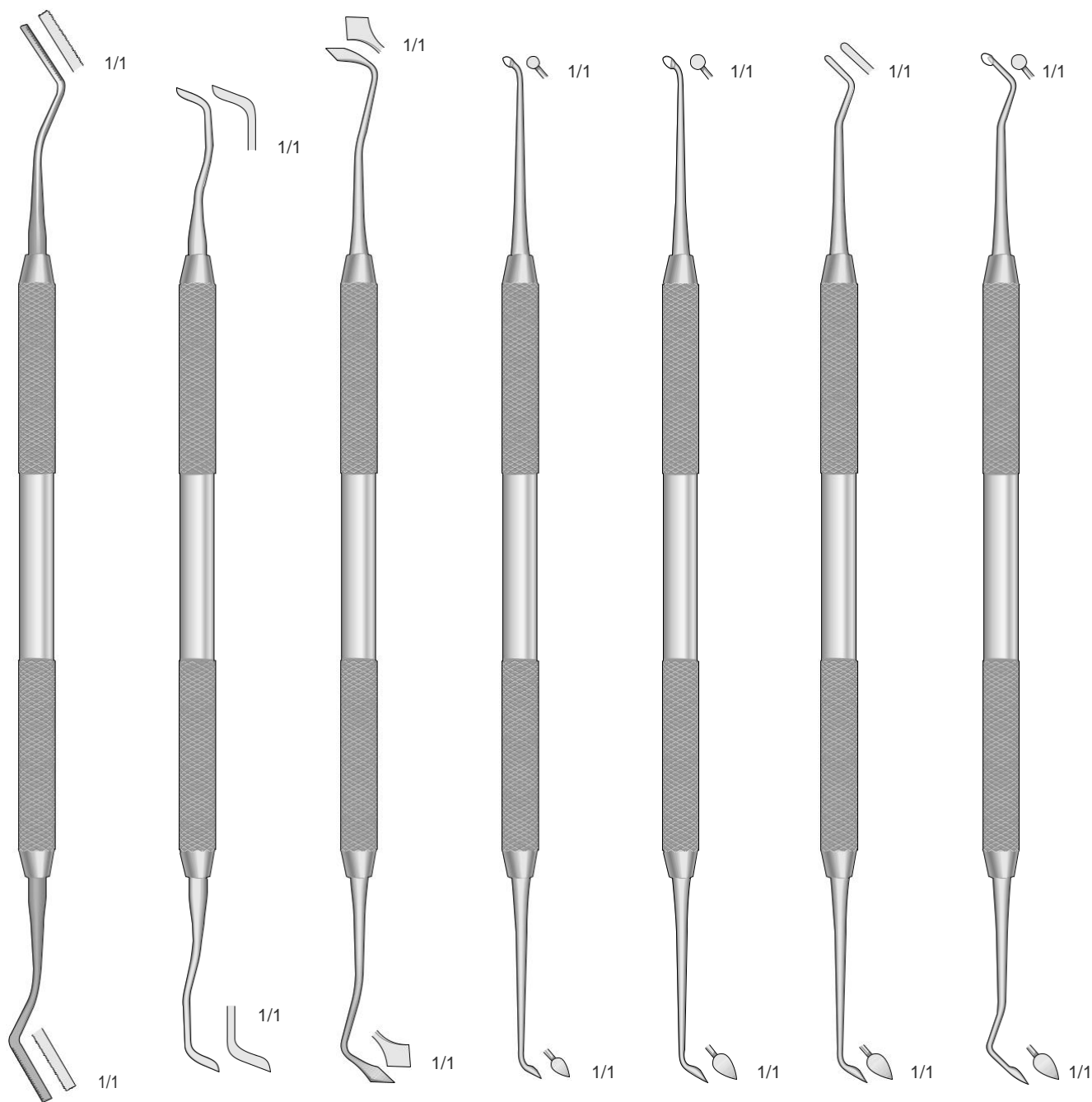
SSI-R-3
HOLLENBACH
3 - 165 mm



Amalgam Instrumente
Amalgam Carvers
Strumenti per modellare l'amalgama
Instrumentos para modelar las obturaciones
Instruments à modeler l'amalgame

Instrument für Drahrückzug
Instrument for retractor wire
Strumento per filo retrattore
Instrumento para hilo separador
Instruments pour fil séparateur

Cleoids - Discoids



SSI-CV-11

SSI-SSI-USC-2
USC

SSI-F-2/3
FRAHM

SSI-CD-1V
Fig. 1/2

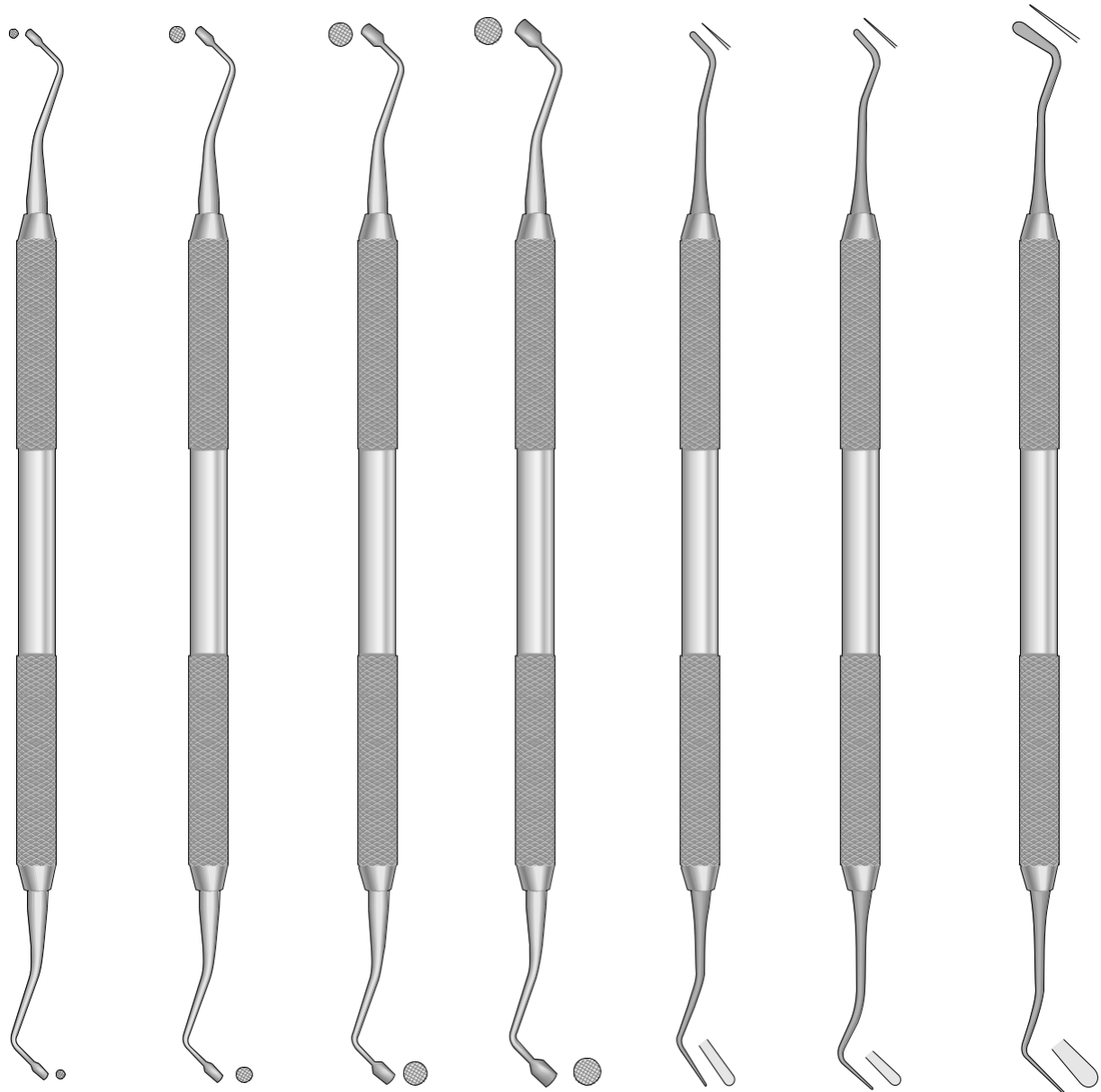
SSI-CD-2
Fig. 4/5

SSI-CD-3
Fig. W.A.C.D.

SSI-CD-4
Fig. 3/6

Email: sheffieldsurgicalinstruments@gmail.com
Web: www.sheffieldsurgicalinst.com

Füllungsinstrumente
Filling Instruments
Strumenti per otturazione
Instrumentos para obturación
Instruments pour obturation



SSI-O-1

SSI-O-2

SSI-O-3

SSI-O-4

SSI-OK-1

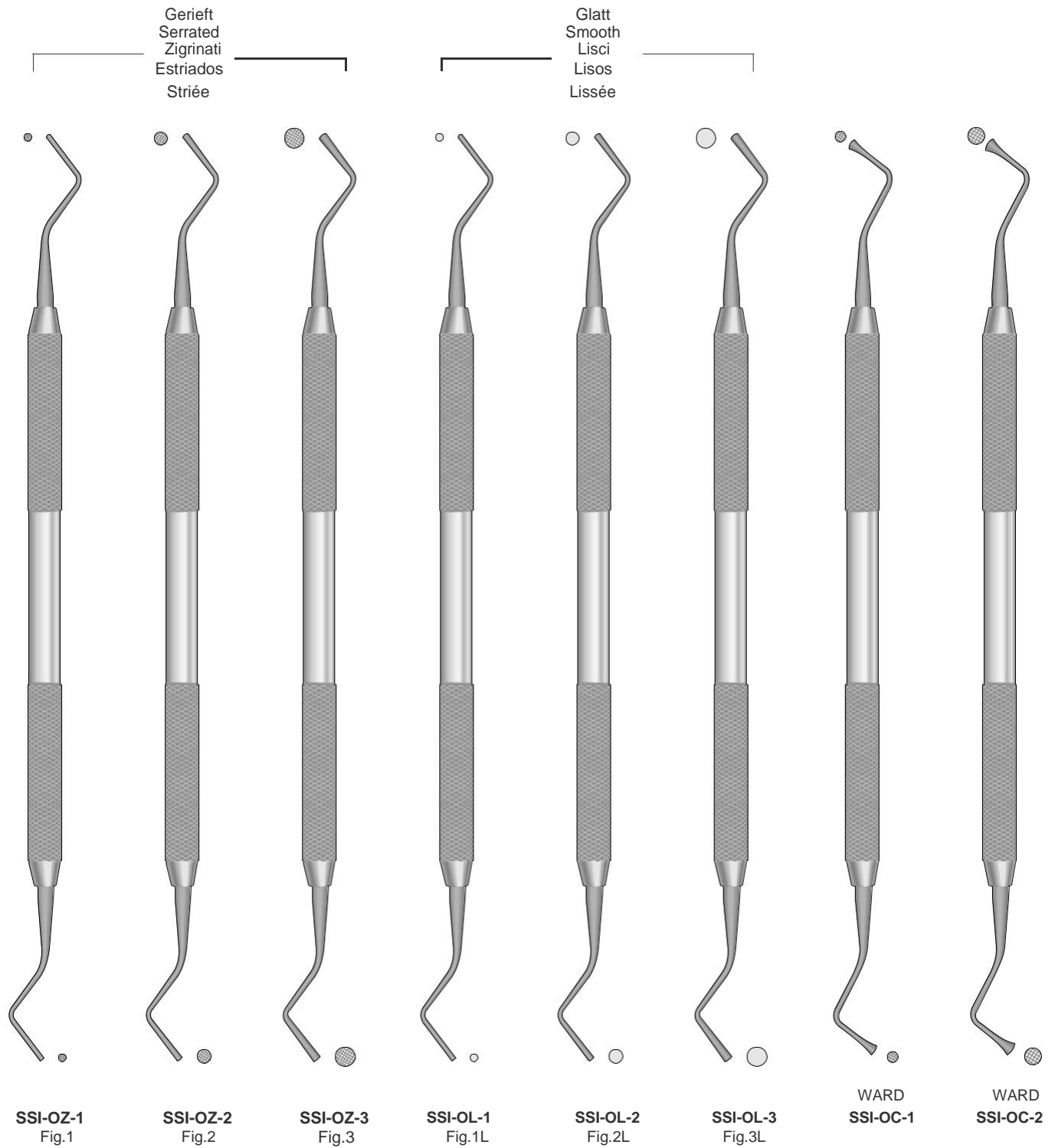
SSI-OK-2

SSI-OK-3

Email: sheffieldsurgicalinstruments@gmail.com
Web: www.sheffieldsurgicalinst.com

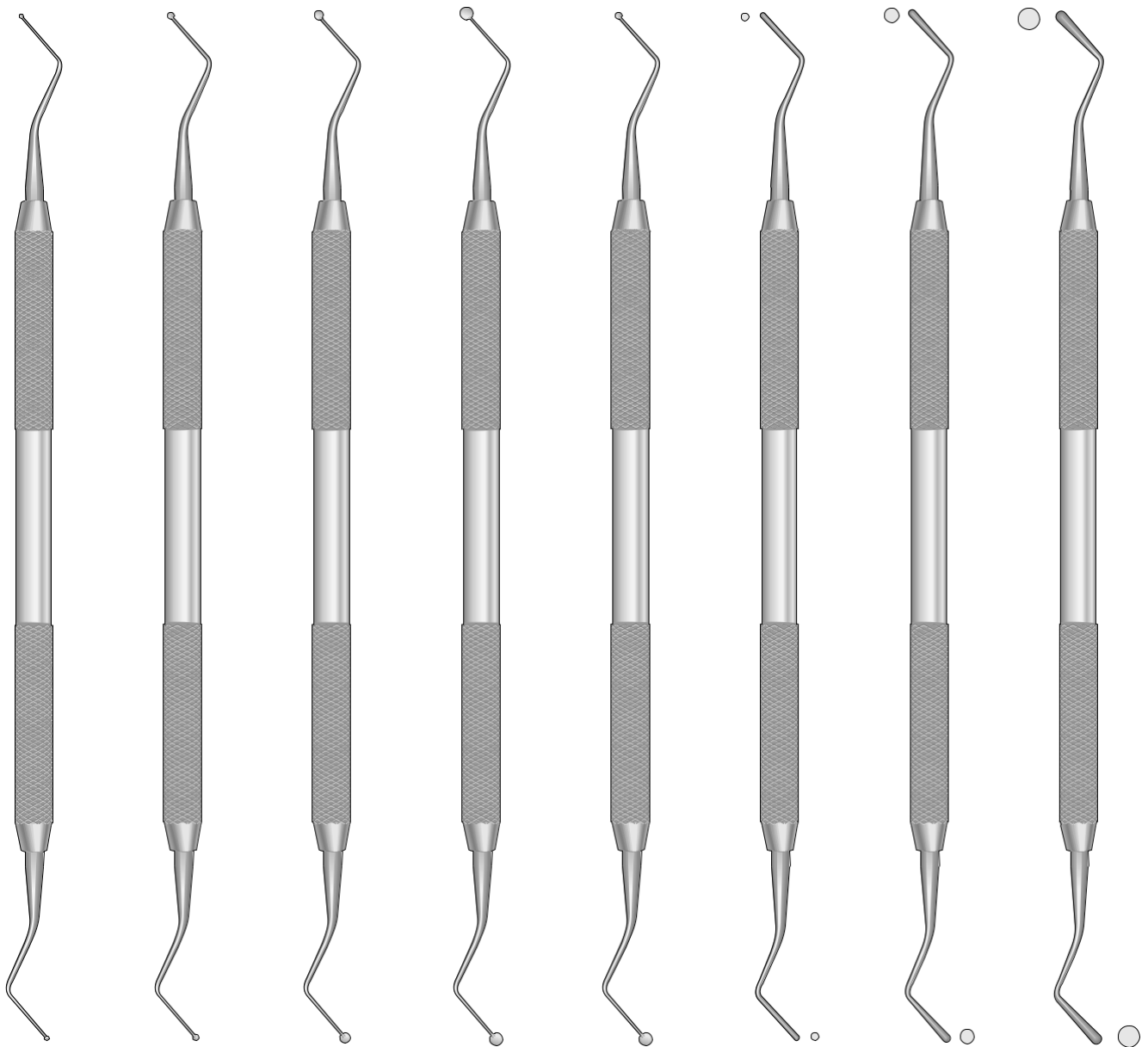


Füllungsinstrumente
Filling Instruments
Strumenti per otturazione
Instrumentos para obturación
Instruments pour obturation



Email: sheffieldsurgicalinstruments@gmail.com
Web: www.sheffieldsurgicalinst.com

Füllungsinstrumente
Filling Instruments
Strumenti per otturazione
Instrumentos para obturación
Instruments pour obturation



SSI-OP-1
Fig.1

SSI-OP-2
Fig.2

SSI-OP-3
Fig.3

SSI-OP-4
Fig.4

SSI-OP-5
Fig.5

SSI-OA-1
Fig.1

SSI-OA-2
Fig.2

SSI-OA-3
Fig.3

Email: sheffieldsurgicalinstruments@gmail.com
Web: www.sheffieldsurgicalinst.com



Füllungsinstrumente
Filling Instruments
Strumenti per otturazione
Instrumentos para obturación
Instruments pour obturation



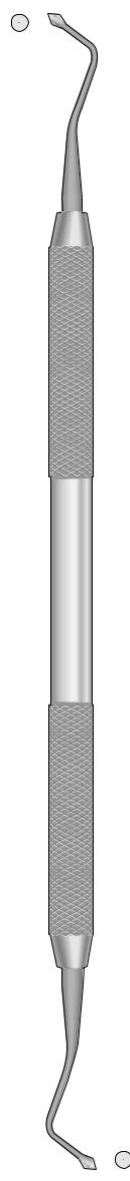
SSI-OX-1



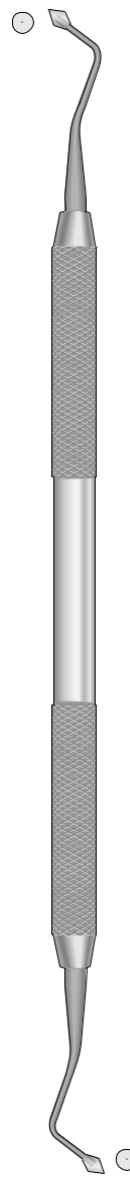
SSI-OX-2



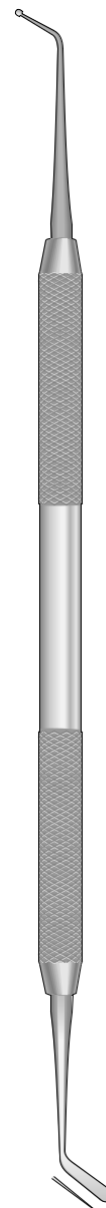
SSI-OX-3



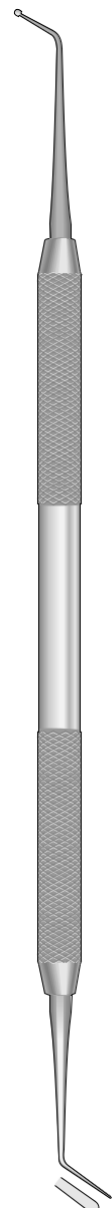
WESTCOTT
SSI-OS-1



WESTCOTT
SSI-OS-2



SSI-OM-2



SSI-ON-1

Email: sheffieldsurgicalinstruments@gmail.com
Web: www.sheffieldsurgicalinst.com

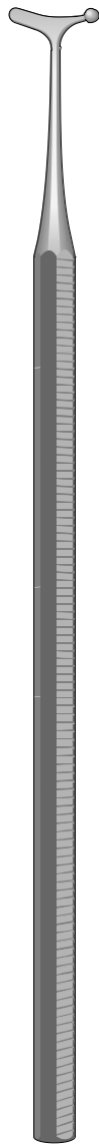
Füllungsinstrumente
 Filling Instruments
 Strumenti per otturazione
 Instrumentos para obturación
 Instruments pour obturation



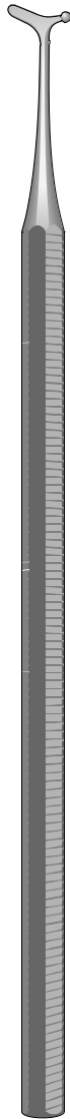
WHITE
 SSI-B-3
 n°28



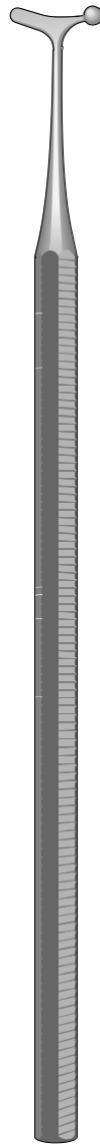
WHITE
 SSI-B-4
 n°29



WHITE
 SSI-B-32
 n°32



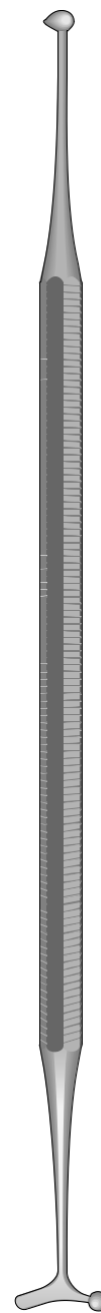
WHITE
 SSI-B-33
 n°33



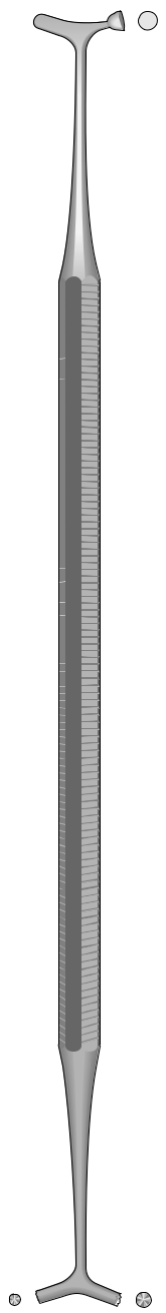
WHITE
 SSI-B-34
 n°34



WHITE
 SSI-B-28/29
 Doppio



WHITE
 SSI-B-31/32
 Doppio

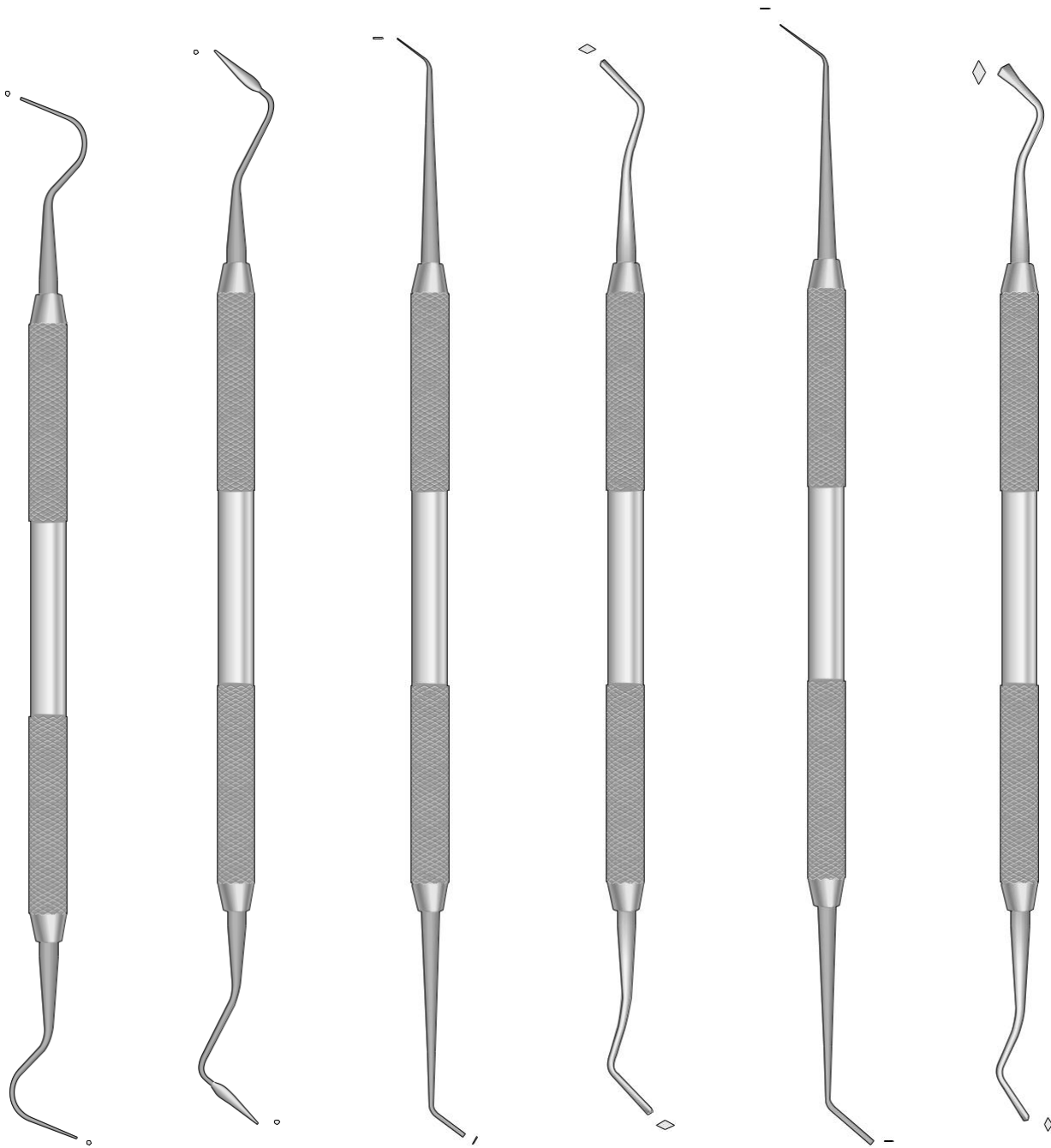


BENNET
 SSI-B-35
 170 mm



Füllungsinstrumente
Filling Instruments
Strumenti per otturazione
Instrumentos para obturación
Instruments pour obturation

MARKLEY PLUGGERS
Amalgam Instrumente
Amalgam Instruments
Strumenti per amalgama
Instrumentos para amalgama
Instruments à amalgame



SSI-PM-1
Fig.1M

SSI-PM-2
Fig.2M

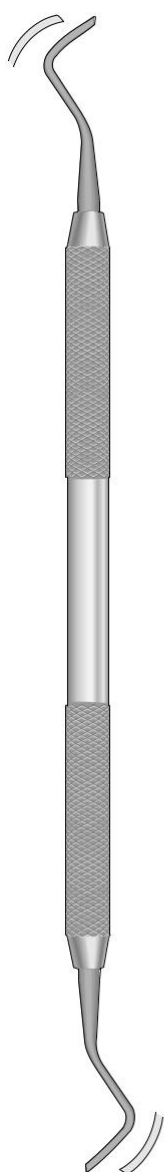
SSI-PM-3
Fig.3M

SSI-PM-4
Fig.4M

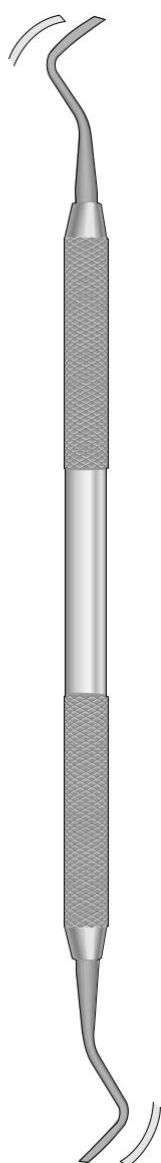
SSI-PM-5
Fig.5M

SSI-PM-6
Fig.6M

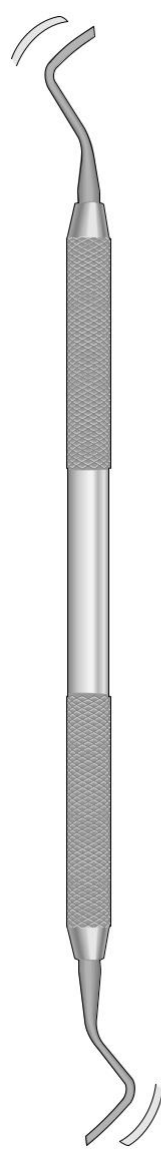
Email: sheffieldsurgicalinstruments@gmail.com
Web: www.sheffieldsurgicalinst.com



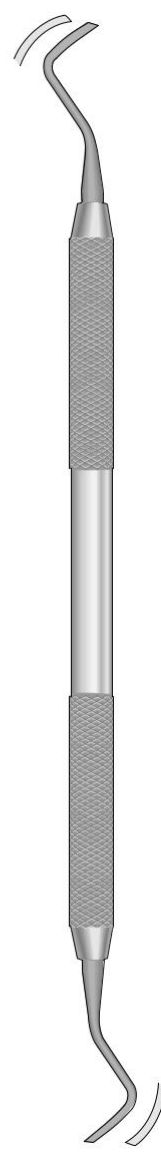
**BLACK
SSI-TS-1**
Fig.26



**BLACK
SSI-TS-2**
Fig.27



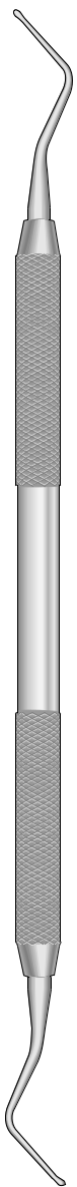
**BLACK
SSI-TS-3**
Fig.28



**BLACK
SSI-TS-4**
Fig.29



Excavatoren
Excavators
Escavatori
Excavadores
Excavateurs



SSI-E-0
Fig.0



SSI-E-1
Fig.1



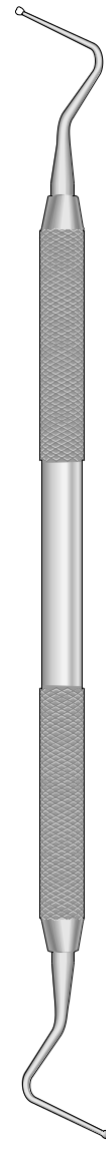
SSI-E-2
Fig.2



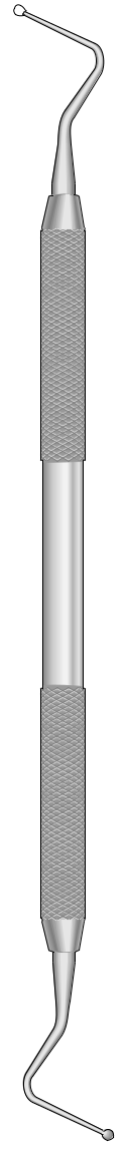
SSI-E-3
Fig.3



SSI-E-4
Fig.4



SSI-EC-1
Fig.1

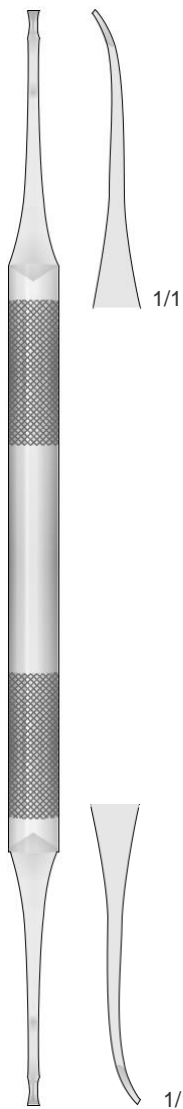


SSI-EC-2
Fig.2

Email: sheffieldsurgicalinstruments@gmail.com
Web: www.sheffieldsurgicalinst.com

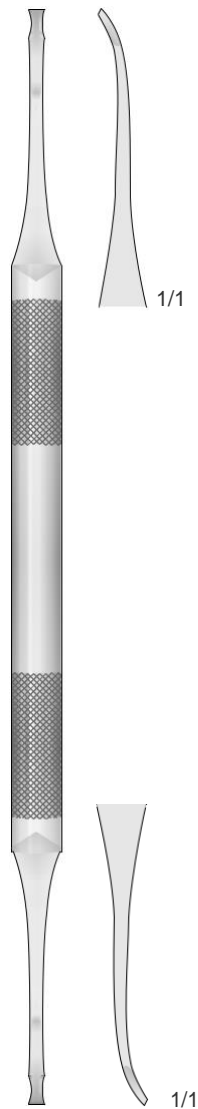
Meißel für Parodontologie
 Periodontal Chisels
 Scalpelli parodontali
 Cinceles periodontales
 Burins parodontaux

Fig. 1



FEDI
 SSI-OF-1
 175 mm

Fig. 2



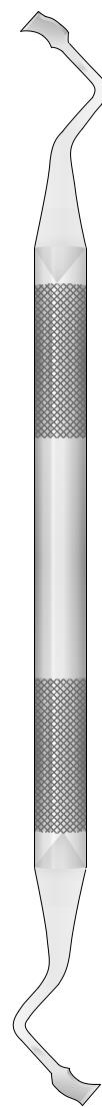
FEDI
 SSI-OF-2
 175 mm

Fig. 3



FEDI
 SSI-OF-3
 170 mm

Fig. 4



OCHSENBEIN
 SSI-OSB-4A
 170 mm



SSI-OSB-4
 170 mm



Meißel für Parodontologie
Periodontal Chisels
Scalpelli parodontali
Cinceles periodontales
Burins parodontaux

Bevel IN
Fig.1



OCHSENBEIN-1
SSI-OSB-1
165 mm

Bevel OUT
Fig.2



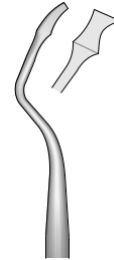
OCHSENBEIN-2
SSI-OSB-2
165 mm



TG CHISELS
SSI-718-113



OCHSENBEIN-3
SSI-718-103



OCHSENBEIN-4
SSI-718-104

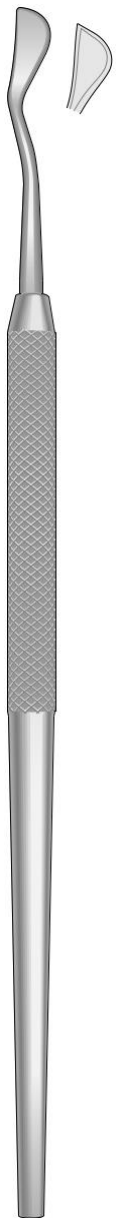


RHODES BACK ACTION
SSI-718-107



Email: sheffieldsurgicalinstruments@gmail.com
Web: www.sheffieldsurgicalinst.com

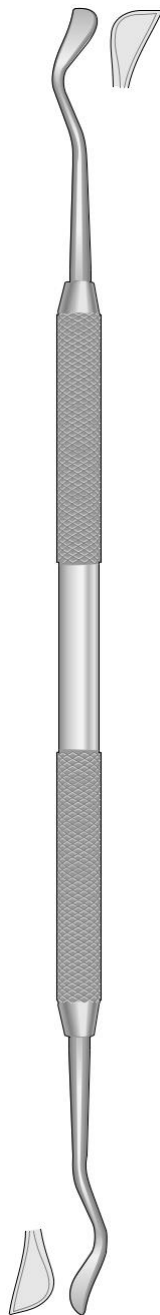
Parodontalmesser
 Gingivectomy Knives
 Bisturi per gengivectomia
 Bisturías para la gengivectomía
 Bistouris pour la gengivectomie



**KIRKLAND
 SSI-KKD-1**
 Fig.15K



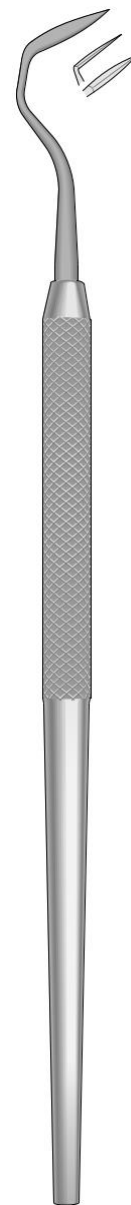
**KIRKLAND
 SSI-KKD-2**
 Fig.16K



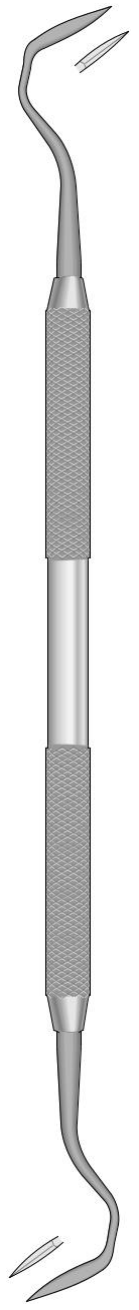
**KIRKLAND
 SSI-KKD-4**
 Fig.15K - Fig.16K



**ORBAN
 SSI-OBN-1**
 Fig.1



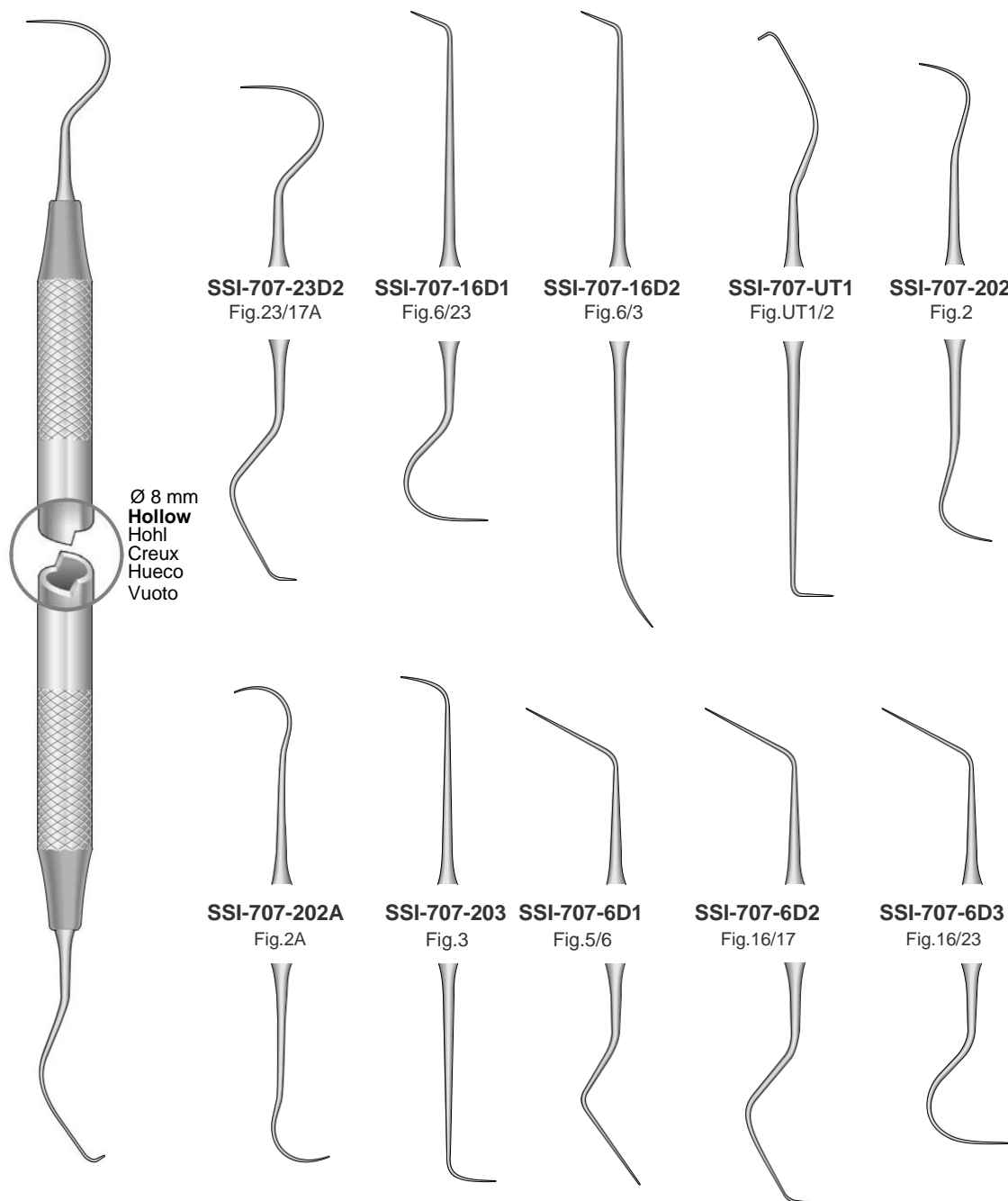
**ORBAN
 SSI-OBN-2**
 Fig.2



**ORBAN
 SSI-OBN-4**
 Fig.1 - Fig.2



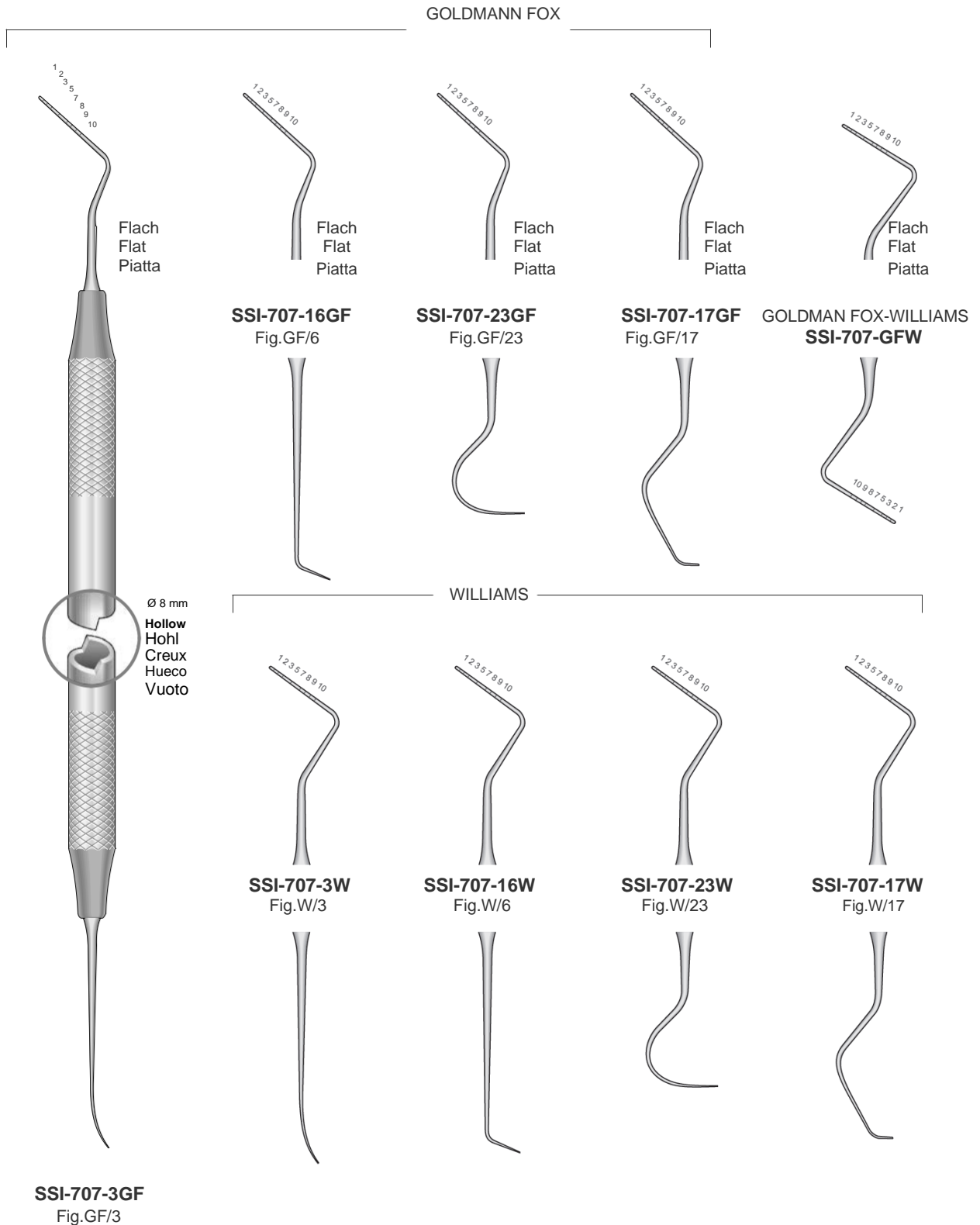
Doppelendiger Zahnsonden
Double-ended Explorer
Sonda falce doppia
Sonda exploradora doble
Sonde exploratrice double



SSI-707-23D1
Fig.23/17

Email: sheffieldsurgicalinstruments@gmail.com
Web: www.sheffieldsurgicalinst.com

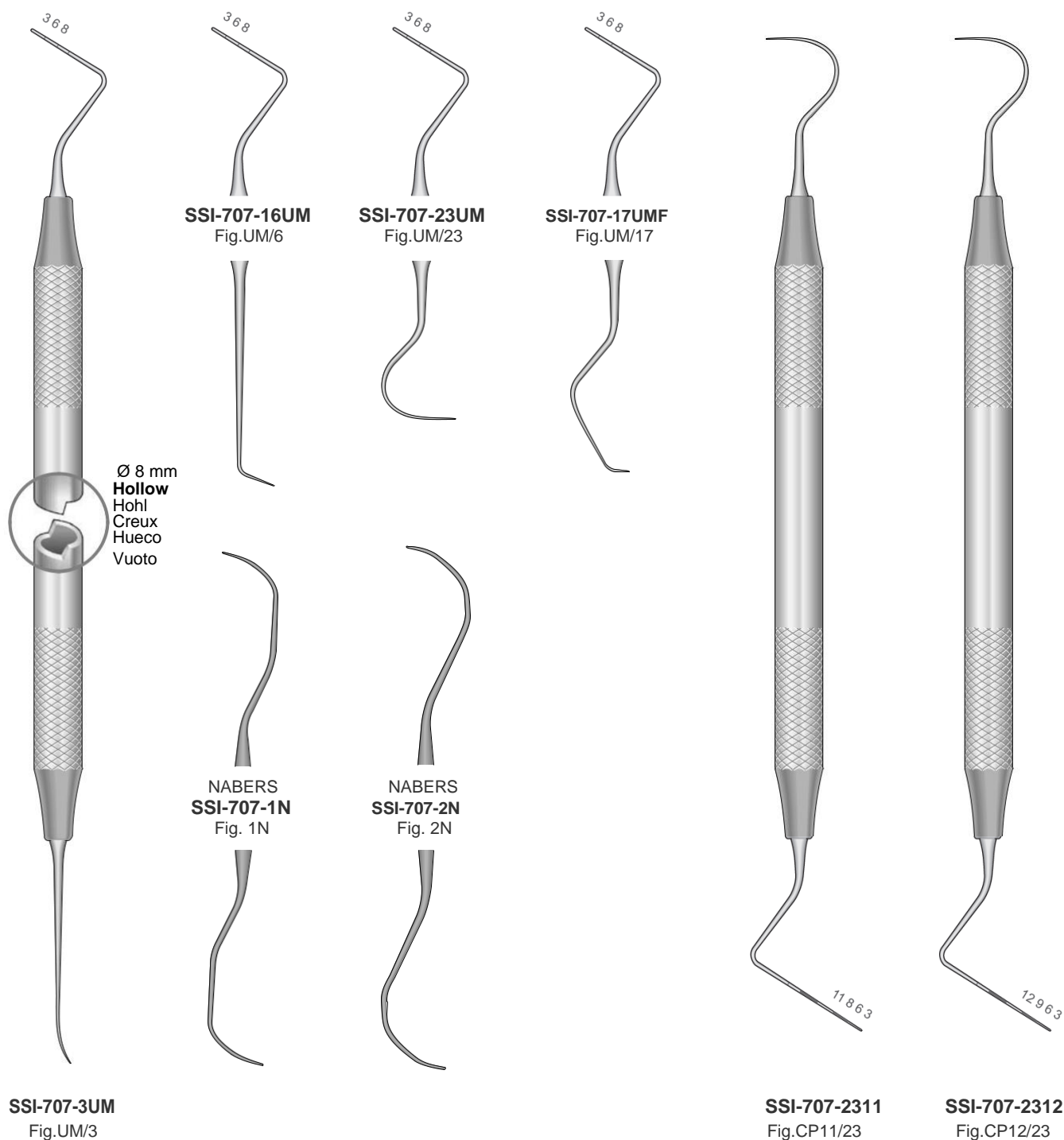
Doppelendiger Parodontometer
 Double-ended Periodontal Probes
 Sondes parodontales doubles
 Sonde parodontali doppie
 Sondas parodontales doubles





Doppelendiger Parodontometer
Double-ended Periodontal Probes
Sondes parodontales doubles
Sonde parodontali doppie
Sondas parodontales doubles

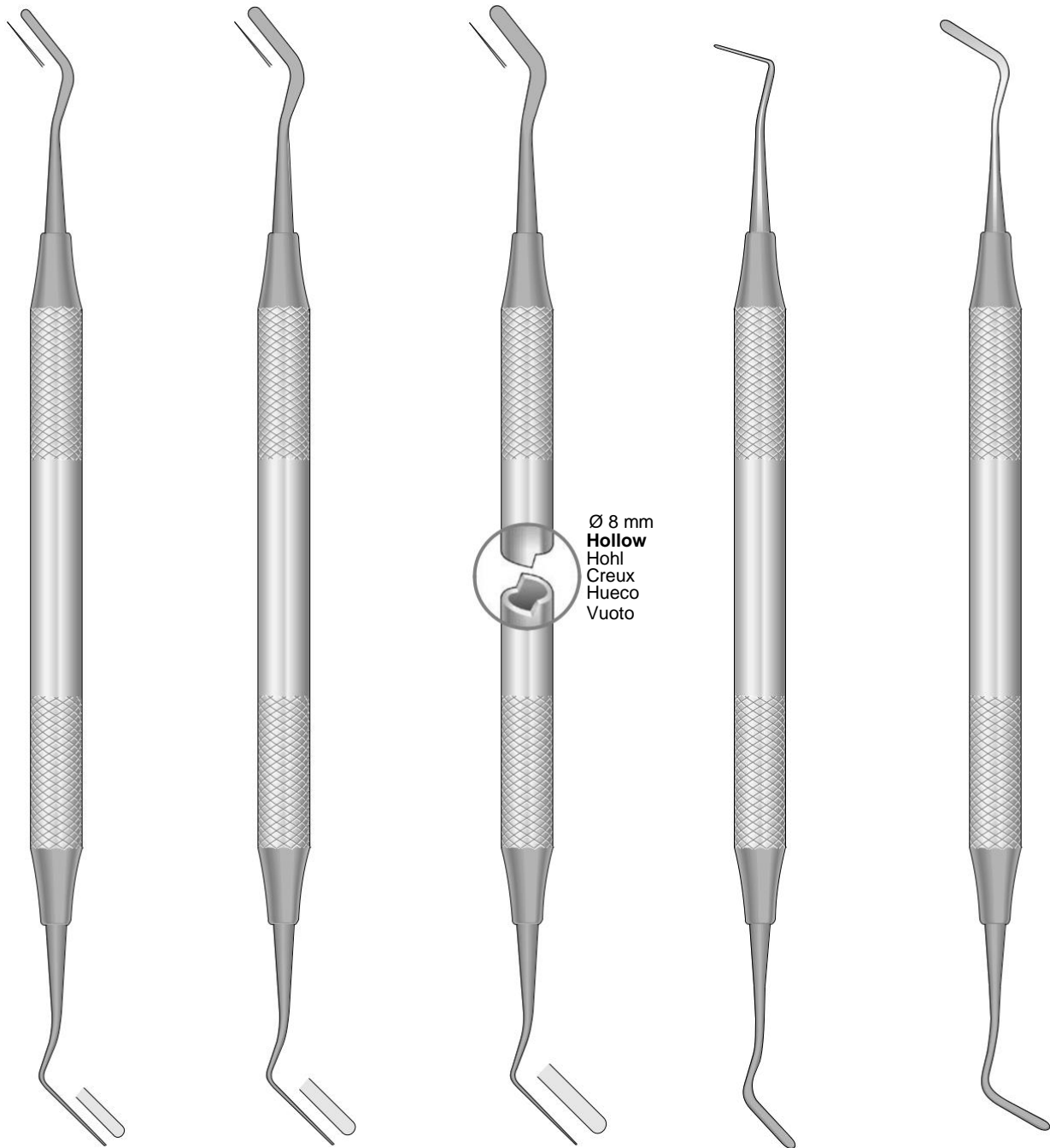
UNIVERSITY OF MICHIGAN



Email: sheffieldsurgicalinstruments@gmail.com
Web: www.sheffieldsurgicalinst.com

Spateln - Füllungsinstrumente
 Spatulas - Filling Instruments
 Spatole -Strumenti per otturazione
 Espátulas - Instrumentos para obturación
 Spatules - Instruments pour obturation

Heidemann Spateln
 Heidemann Spatulas
 Spatole Heidemann
 Espátulas Heidemann
 Spatules Heidemann



Ø 8 mm
Hollow
 Hohl
 Creux
 Hueco
 Vuoto

HEIDEMANN
 SSI-711-301
 Fig.1

HEIDEMANN
 SSI-711-302
 Fig.2

HEIDEMANN
 SSI-711-303
 Fig.3

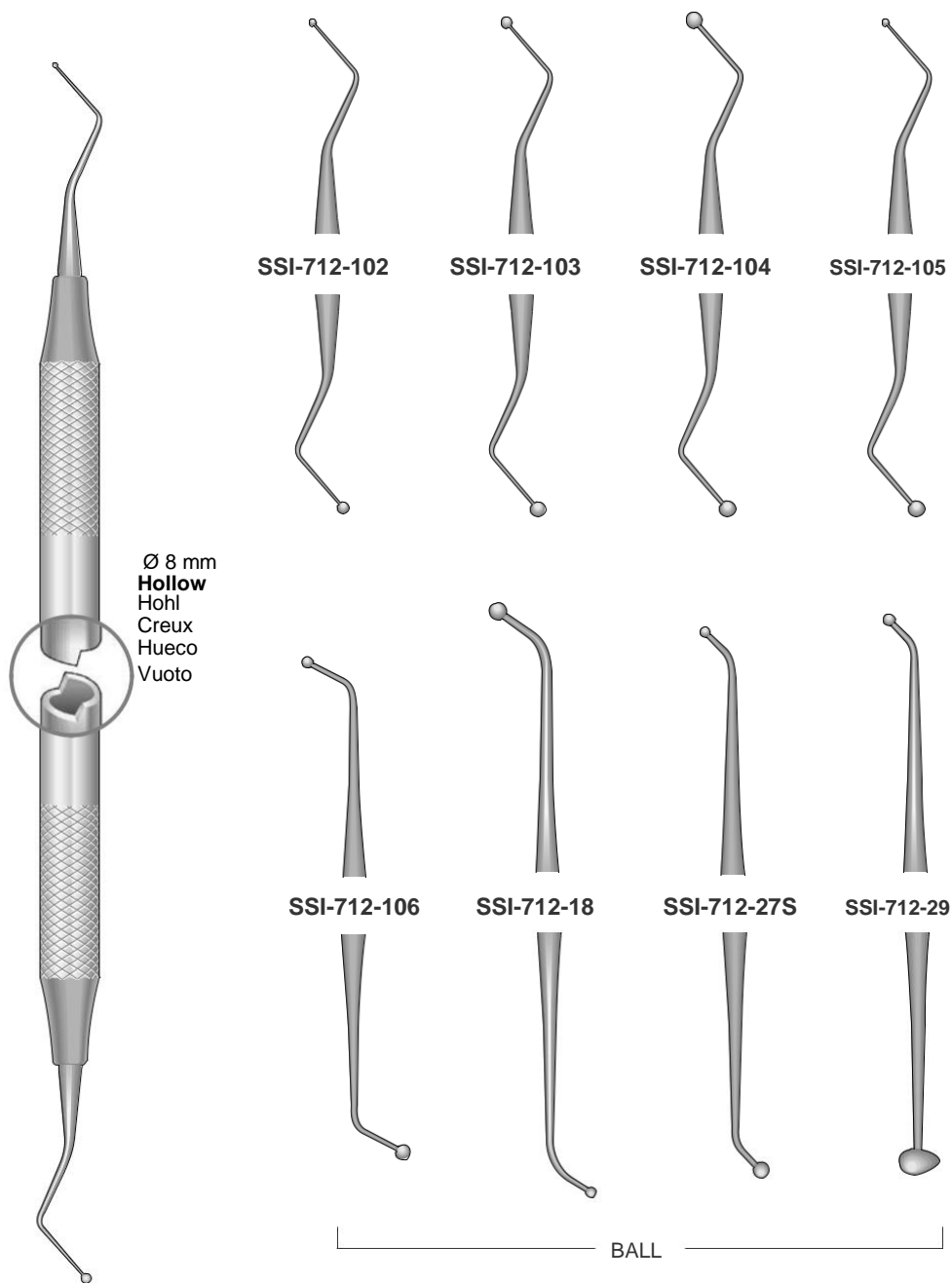
IPC Fig. 1
 SSI-715-311
 Interproximal

IPC/OA Fig. 2
 SSI-715-312
 Interproximal Off-Angle

Email: sheffieldsurgicalinstruments@gmail.com
 Web: www.sheffieldsurgicalinst.com



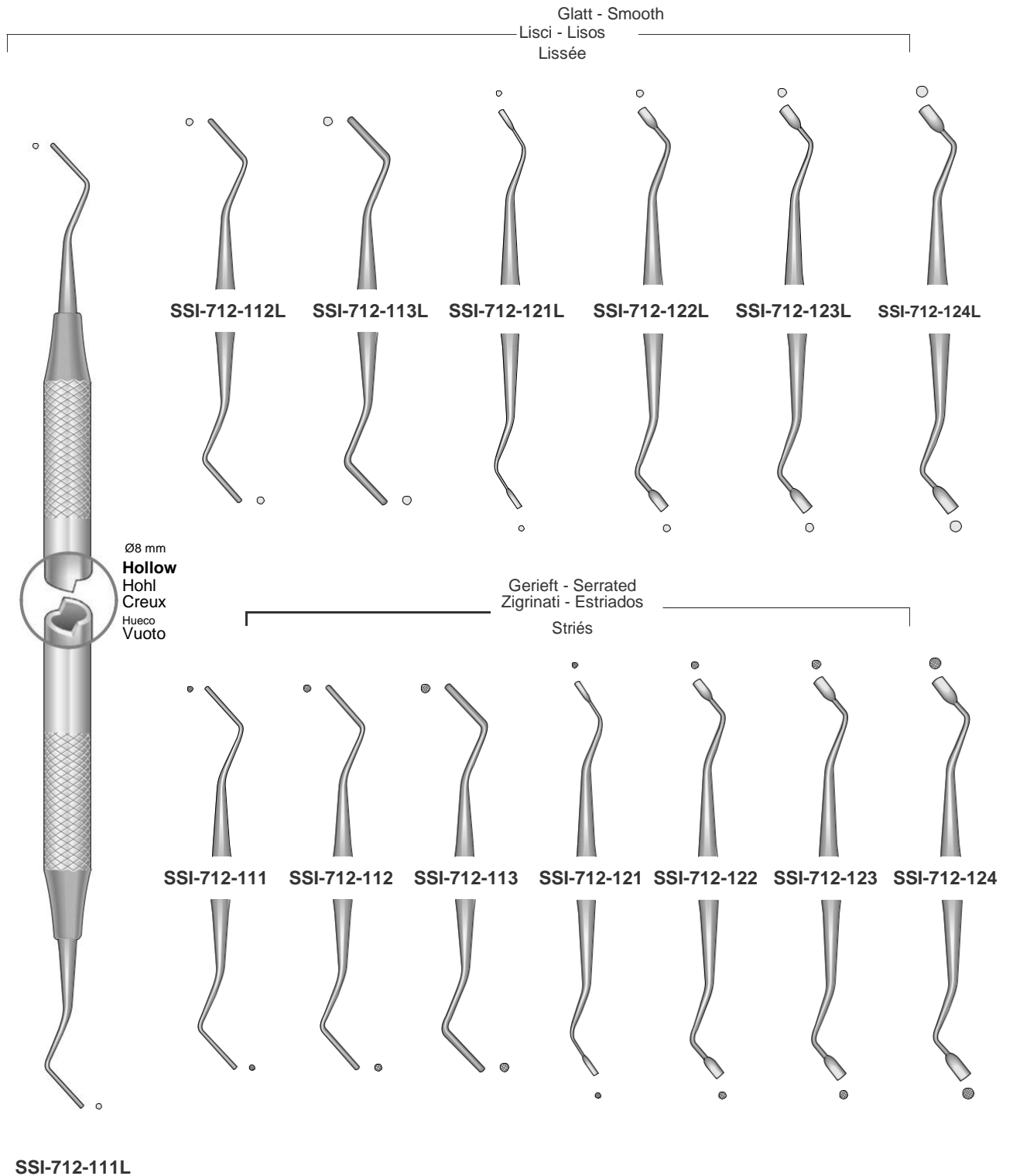
Füllungsinstrumente
Filling Instruments
Strumenti per otturazione
Instrumentos para obturación
Instruments pour obturation



SSI-712-101

Email: sheffieldsurgicalinstruments@gmail.com
Web: www.sheffieldsurgicalinst.com

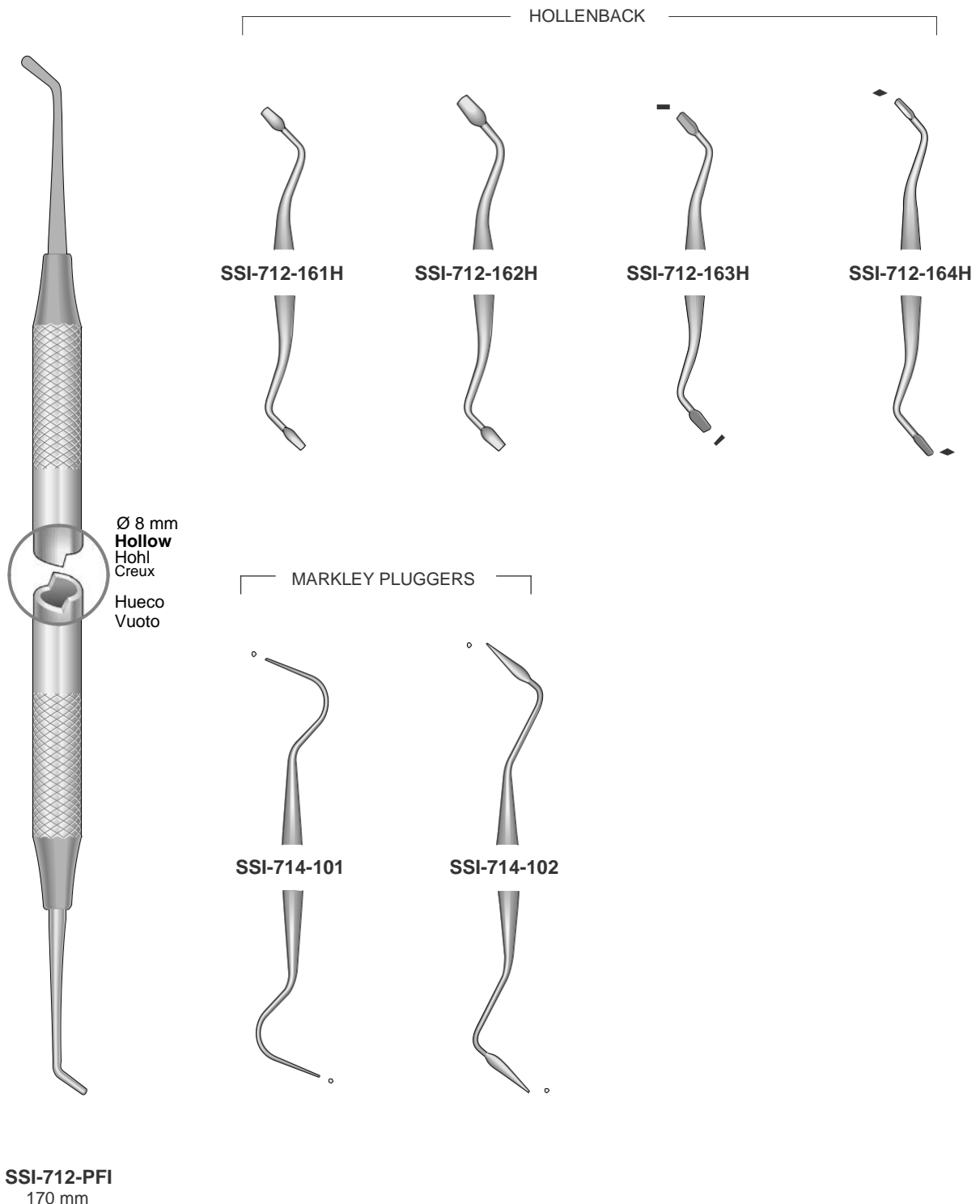
Füllungsinstrumente
 Filling Instruments
 Strumenti per otturazione
 Instrumentos para obturación
 Instruments pour obturation



Email: sheffieldsurgicalinstruments@gmail.com
 Web: www.sheffieldsurgicalinst.com

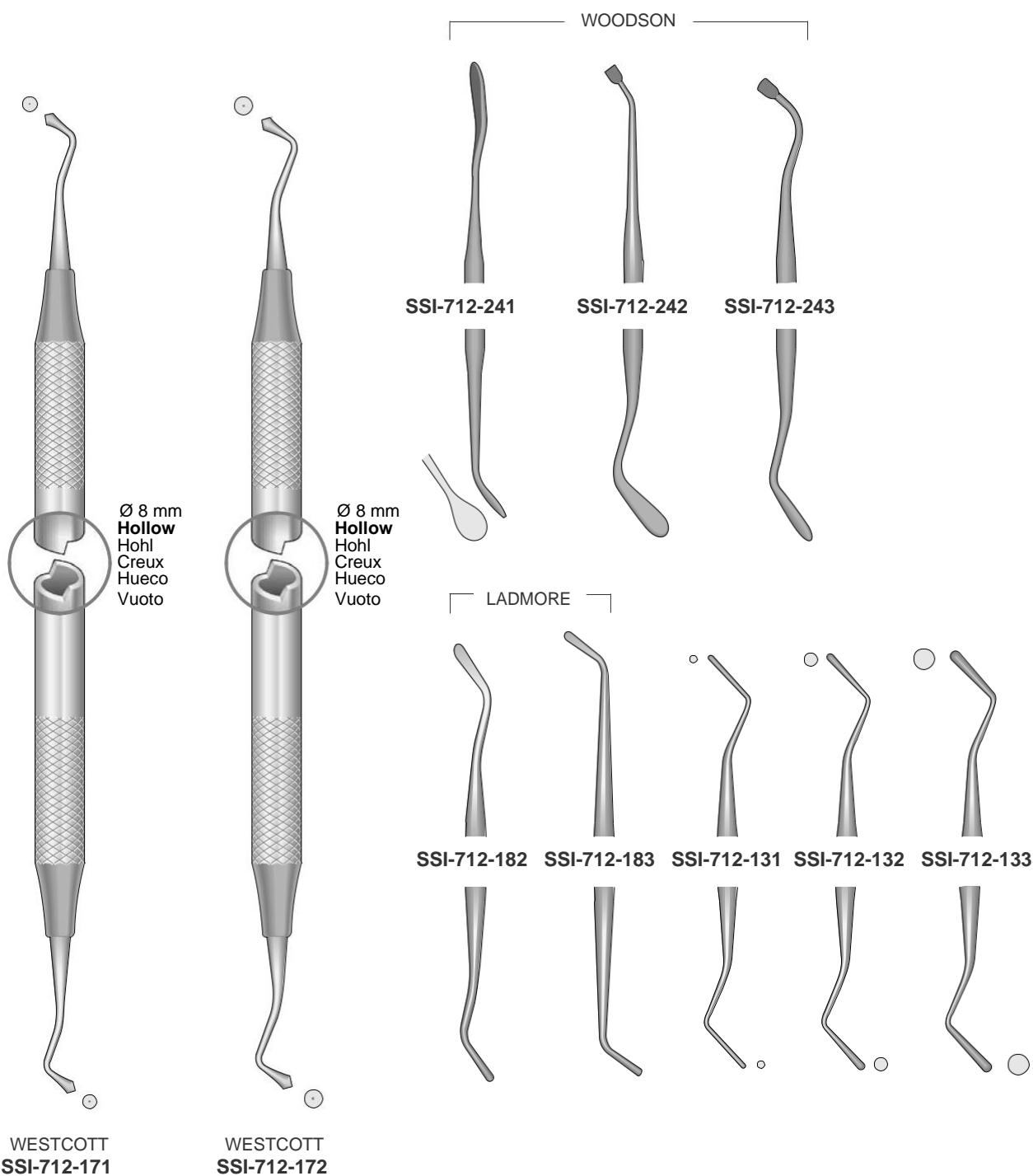


Füllungsinstrumente
Filling Instruments
Strumenti per otturazione
Instrumentos para obturación
Instruments pour obturation



Email: sheffieldsurgicalinstruments@gmail.com
Web: www.sheffieldsurgicalinst.com

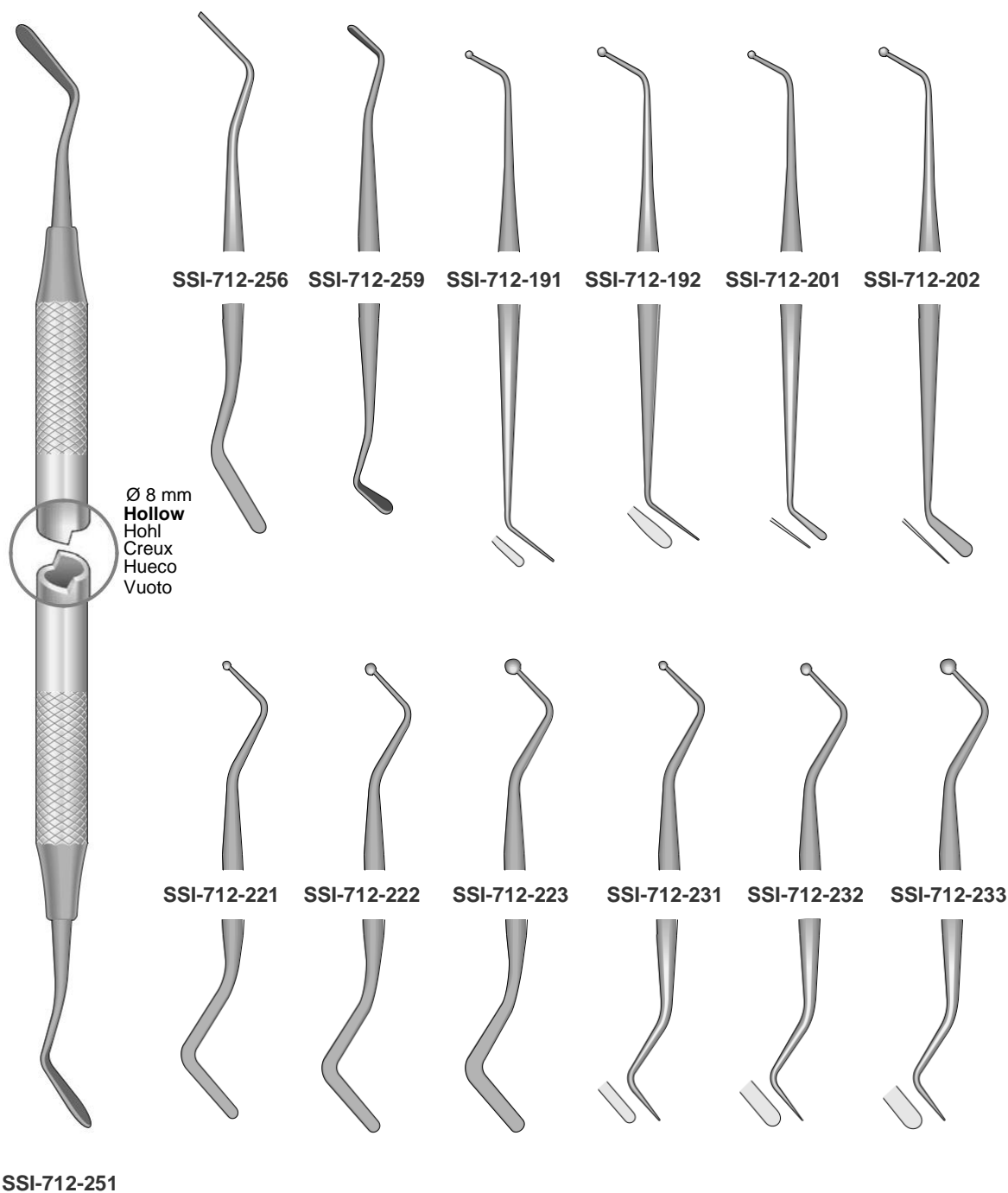
Füllungsinstrumente
 Filling Instruments
 Strumenti per otturazione
 Instrumentos para obturación
 Instruments pour obturation



Email: sheffieldsurgicalinstruments@gmail.com
 Web: www.sheffieldsurgicalinst.com

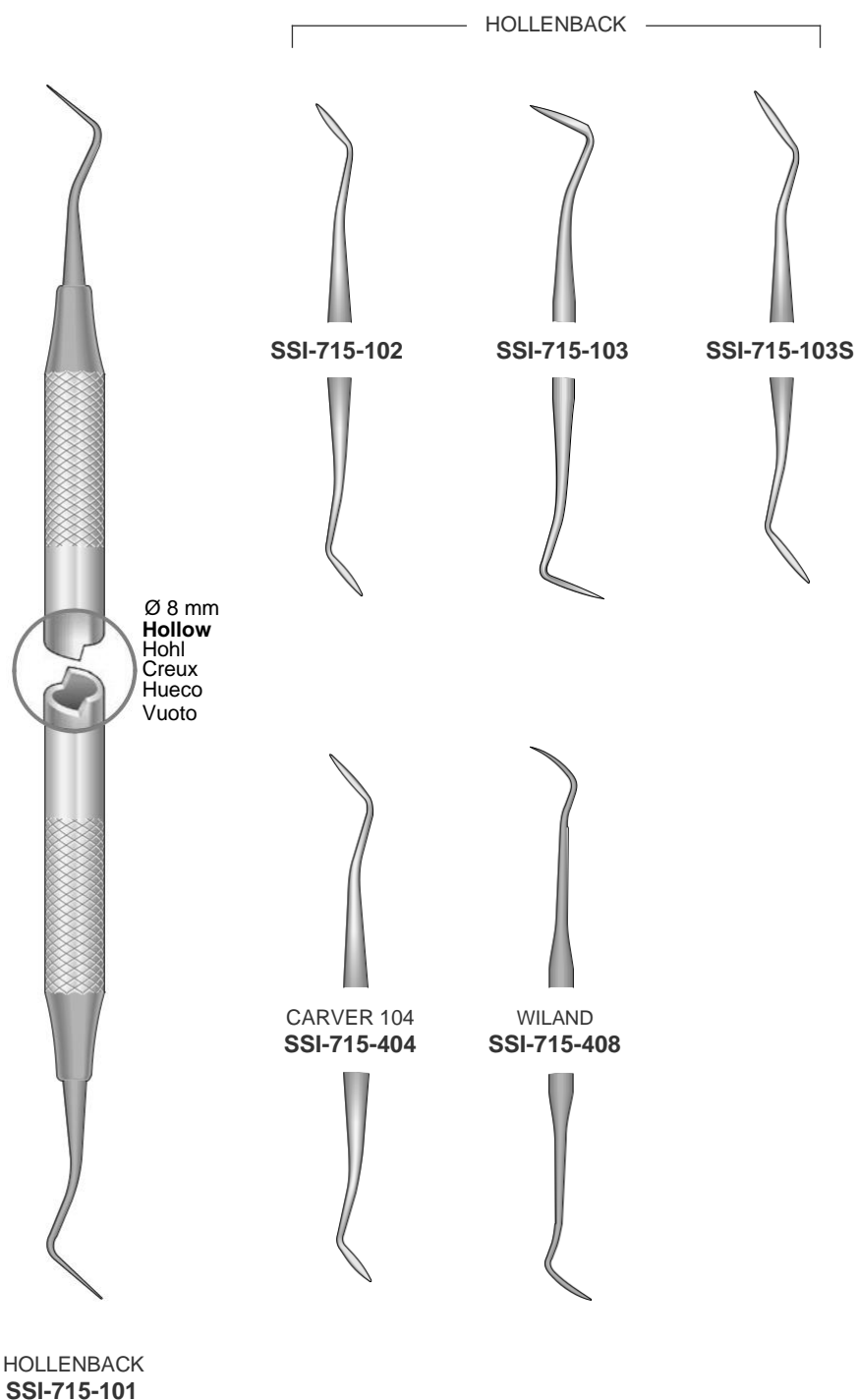


Füllungsinstrumente
Filling Instruments
Strumenti per otturazione
Instrumentos para obturación
Instruments pour obturation



Email: sheffieldsurgicalinstruments@gmail.com
Web: www.sheffieldsurgicalinst.com

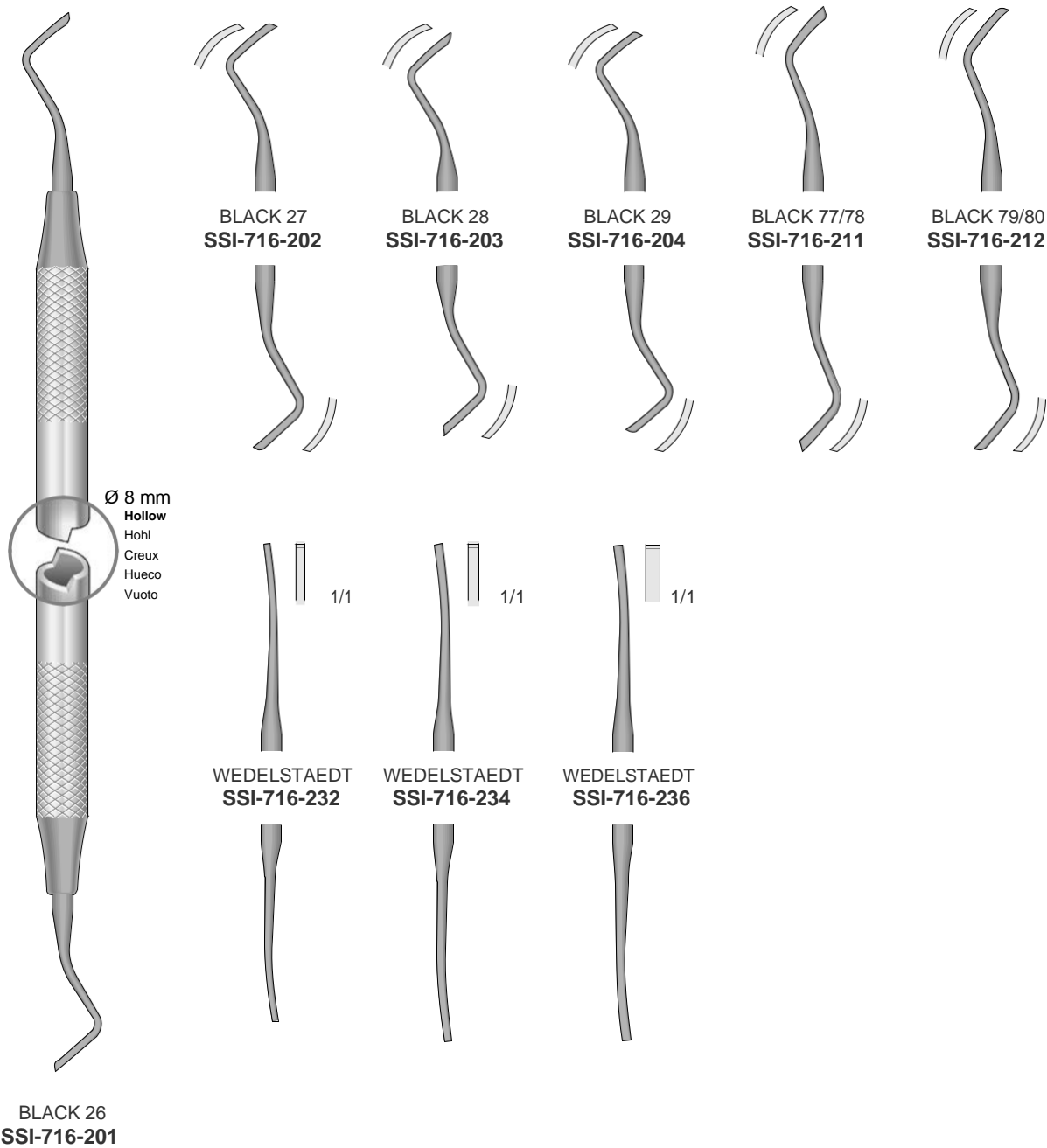
Amalgam Instrumente
 Amalgam carvers
 Strumenti per modellare otturazioni
 Instrumentos para modelar las obturaciones
 Instruments à modeler les obturations



Email: sheffieldsurgicalinstruments@gmail.com
 Web: www.sheffieldsurgicalinst.com



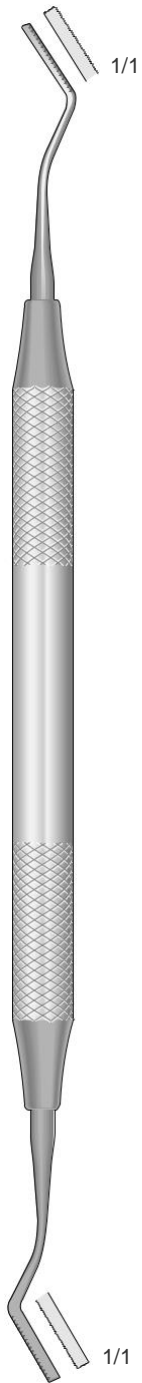
Schmelzinstrumente
Cavity preparation instruments
Strumenti da smalto
Instrumentos para esmalte
Instruments à émail



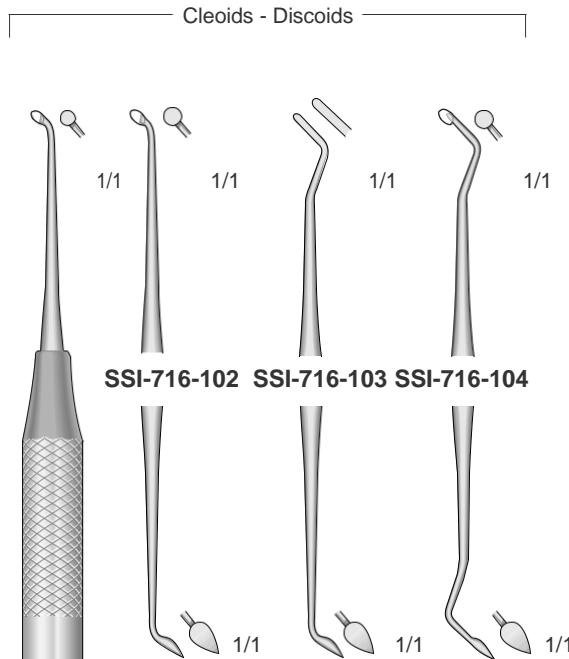
Email: sheffieldsurgicalinstruments@gmail.com
Web: www.sheffieldsurgicalinst.com

Amalgam Instrumente
 Amalgam carvers
 Strumenti per modellare otturazioni
 Instrumentos para modelar las obturaciones
 Instruments à modeler les obturations

Instrument für Drahrückzug
 Instrument for Retractor wire
 Strumento per filo retrattore
 Instrumento para hilo retractor
 Instruments pour fil retracteur



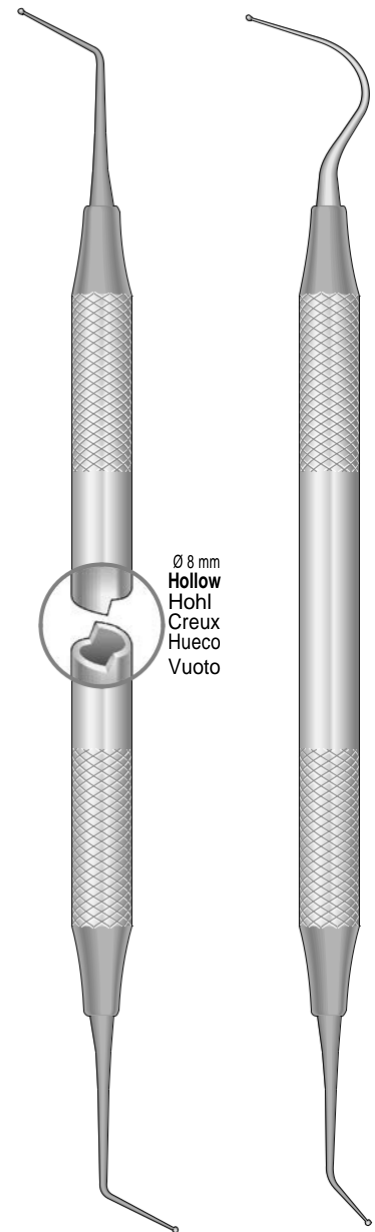
SSI-714-CV11



Ø 8 mm
Hollow
 Hohl
 Creux
 Hueco
 Vuoto

SSI-716-101

Dykal Applikator
 Placement Instruments
 Applicatori per sottofondo
 Aplicadores de fondo de cavidades
 Appicateurs de fond de cavité



SSI-713-101

SSI-713-102

Email: sheffieldsurgicalinstruments@gmail.com
 Web: www.sheffieldsurgicalinst.com



Excavatore
Excavators
Escavatori
Excavadores
Excavateurs

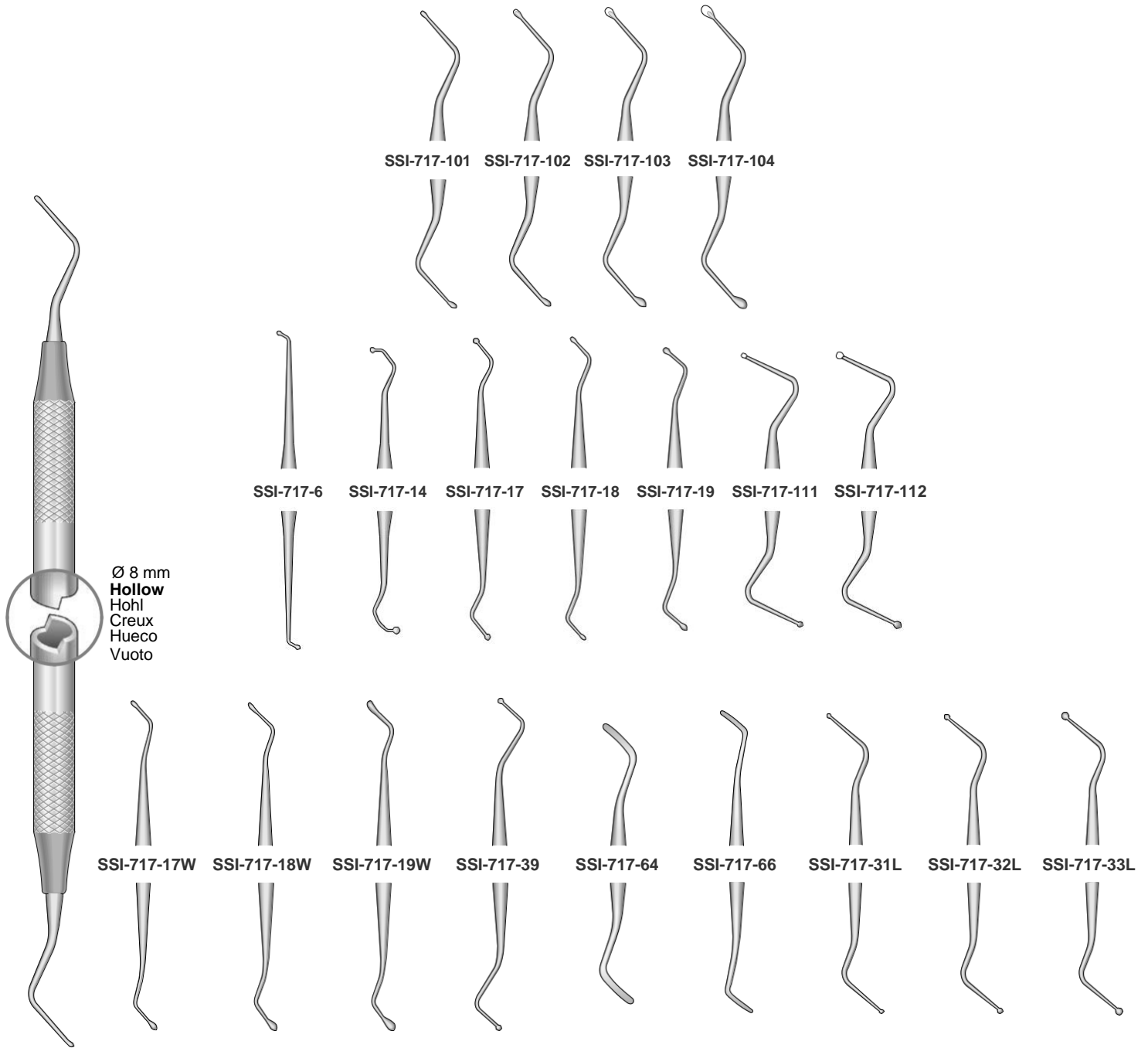


Fig. 2

SSI-717-100

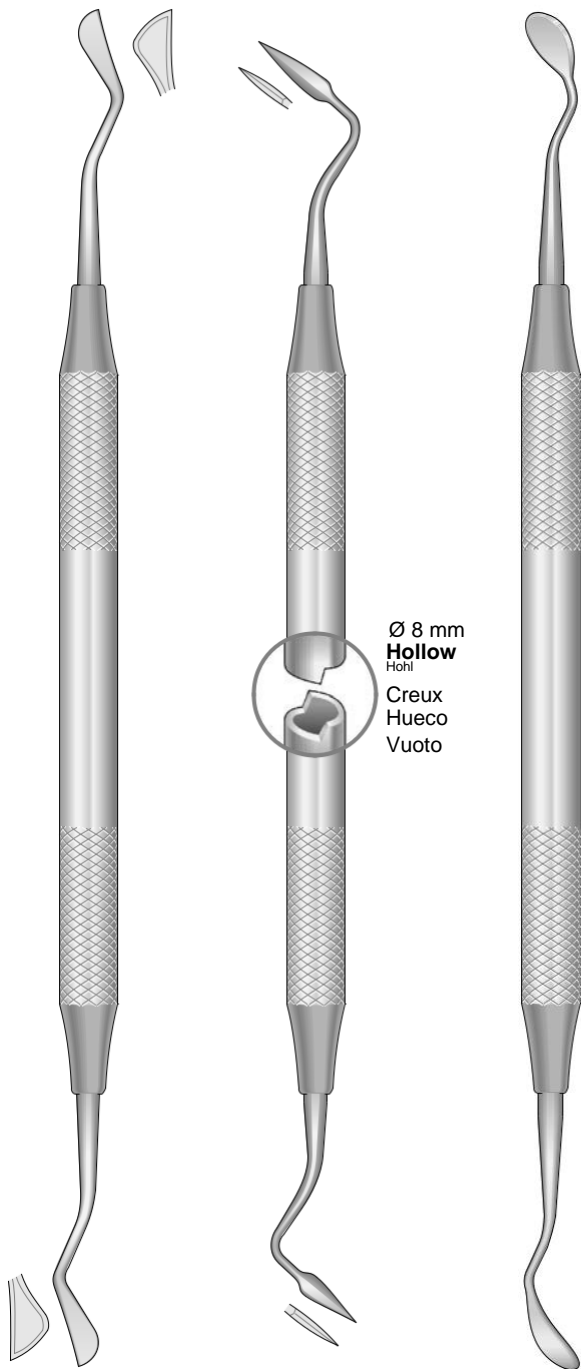
Email: sheffieldsurgicalinstruments@gmail.com
Web: www.sheffieldsurgicalinst.com

Quality

Instruments

Since 1992

Parodontalmesser
 Gingivectomy knives
 Bisturi per gengivectomia
 Bisturís para la gingivectomía
 Bistouris pour la gingivectomie

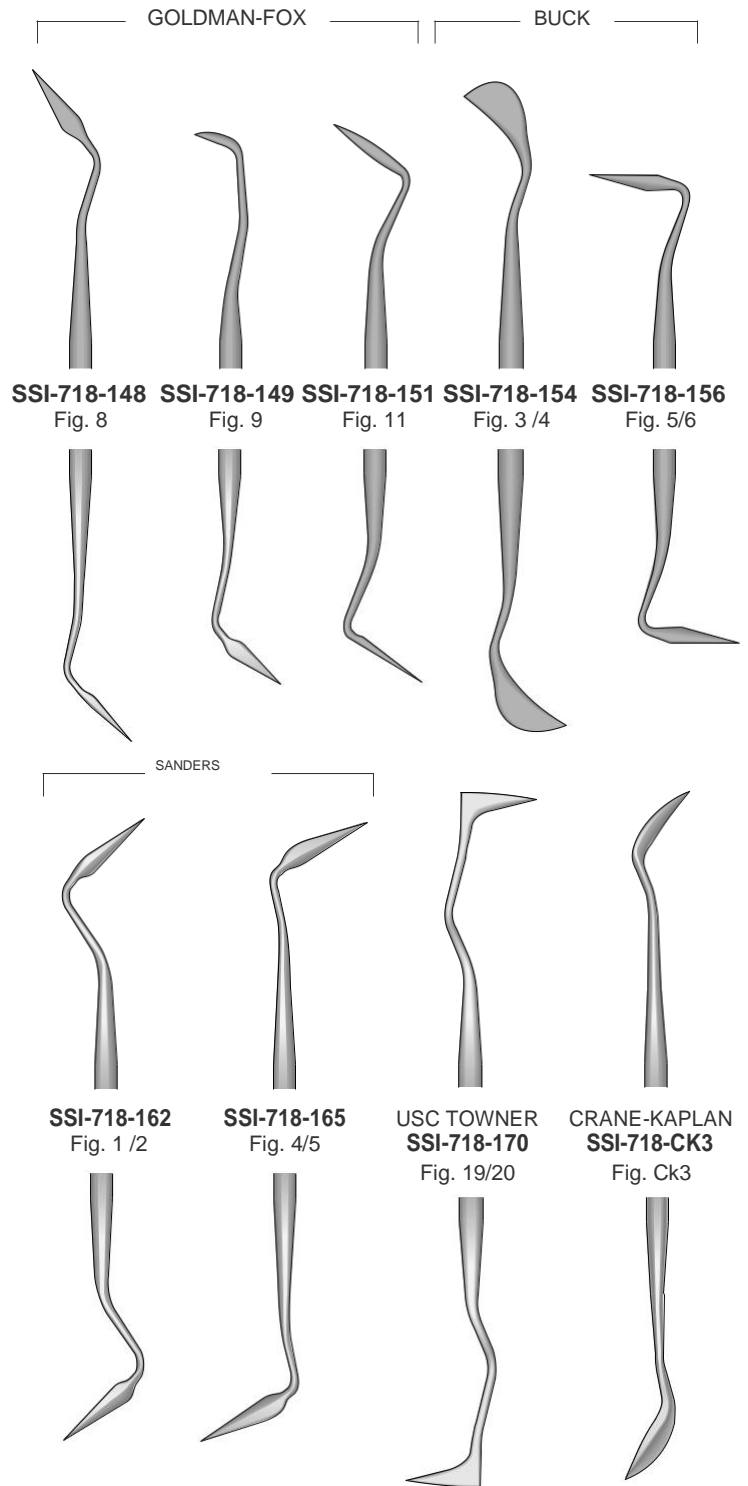


KIRKLAND
SSI-718-123
 Fig. 15K/16K

ORBAN
SSI-718-133
 Fig. 1/2

GOLDMAN-FOX
SSI-718-147
 Fig. 7

Ø 8 mm
Hollow
 Hohl
 Creux
 Hueco
 Vuoto



SSI-718-148 **SSI-718-149** **SSI-718-151** **SSI-718-154** **SSI-718-156**
 Fig. 8 Fig. 9 Fig. 11 Fig. 3/4 Fig. 5/6

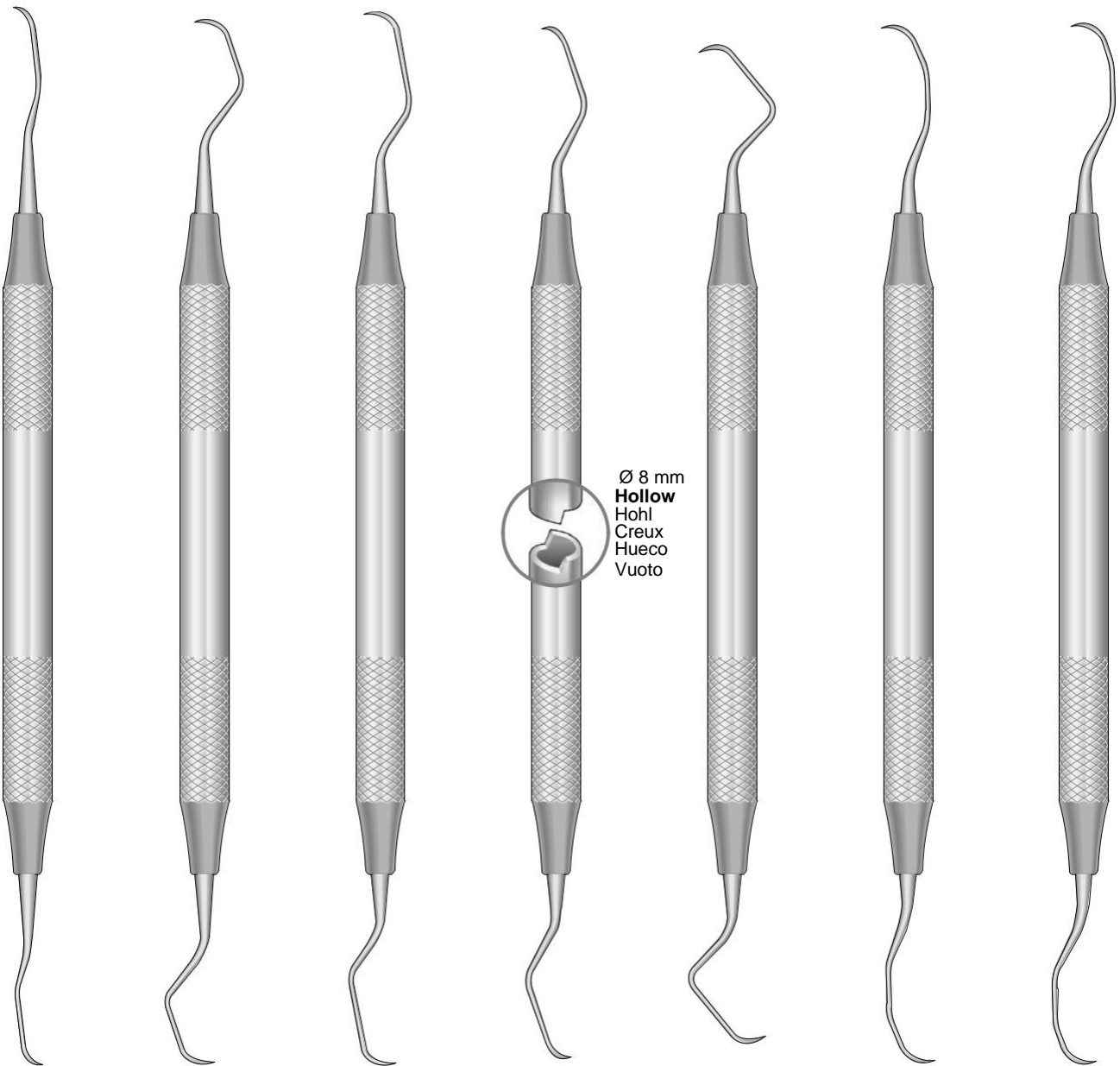
SSI-718-162 **SSI-718-165** **USC TOWNER** **CRANE-KAPLAN**
 Fig. 1/2 Fig. 4/5 **SSI-718-170** **SSI-718-CK3**
 Fig. 19/20 Fig. Ck3

Email: sheffieldsurgicalinstruments@gmail.com
 Web: www.sheffieldsurgicalinst.com



Küretten
Curettes
Curette
Curetas
Curettes

GRACEY



GRACEY
SSI-718-1/2

GRACEY
SSI-718-3/4

GRACEY
SSI-718-5/6

GRACEY
SSI-718-7/8

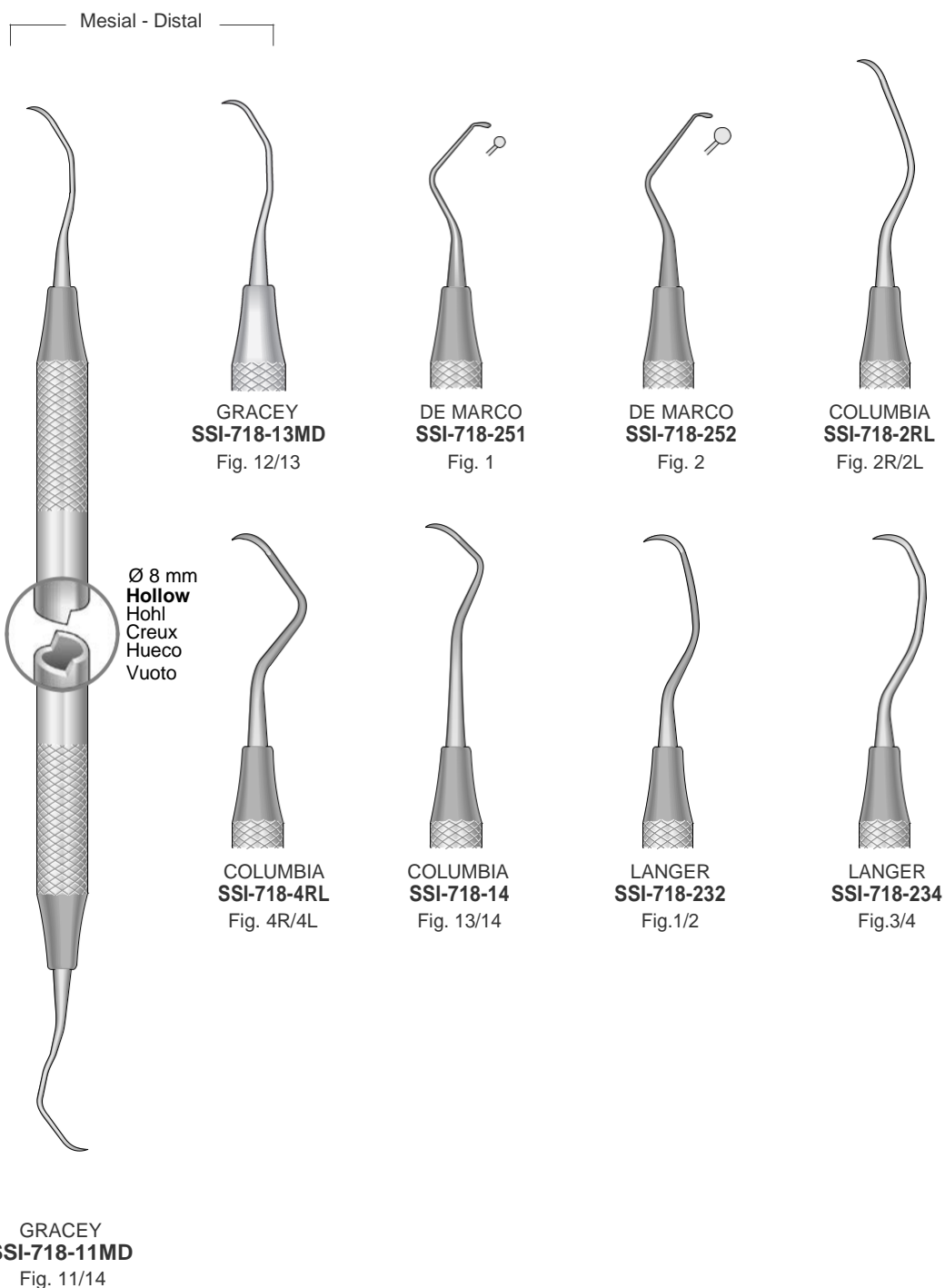
GRACEY
SSI-718-9/10

GRACEY
SSI-718-11/12

GRACEY
SSI-718-13/14

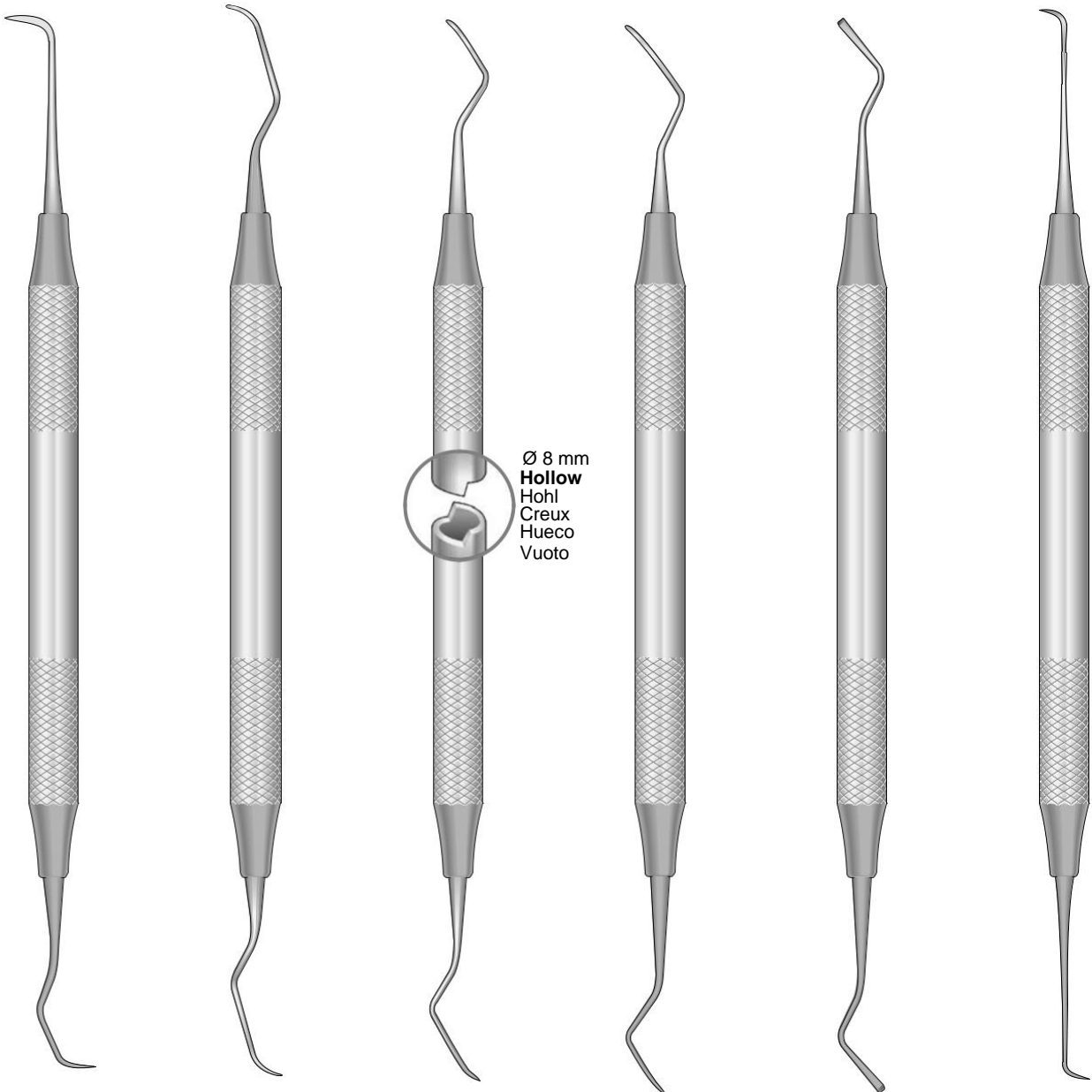
Email: sheffieldsurgicalinstruments@gmail.com
Web: www.sheffieldsurgicalinst.com

Küretten
Curettes
Curette
Curetas
Curettes





Küretten
Curettes
Curette
Curetas
Curettes



GOLDMAN-FOX
SSI-718-271
Fig. 1

GOLDMAN-FOX
SSI-718-272
Fig. 2

GOLDMAN-FOX
SSI-718-273
Fig. 3

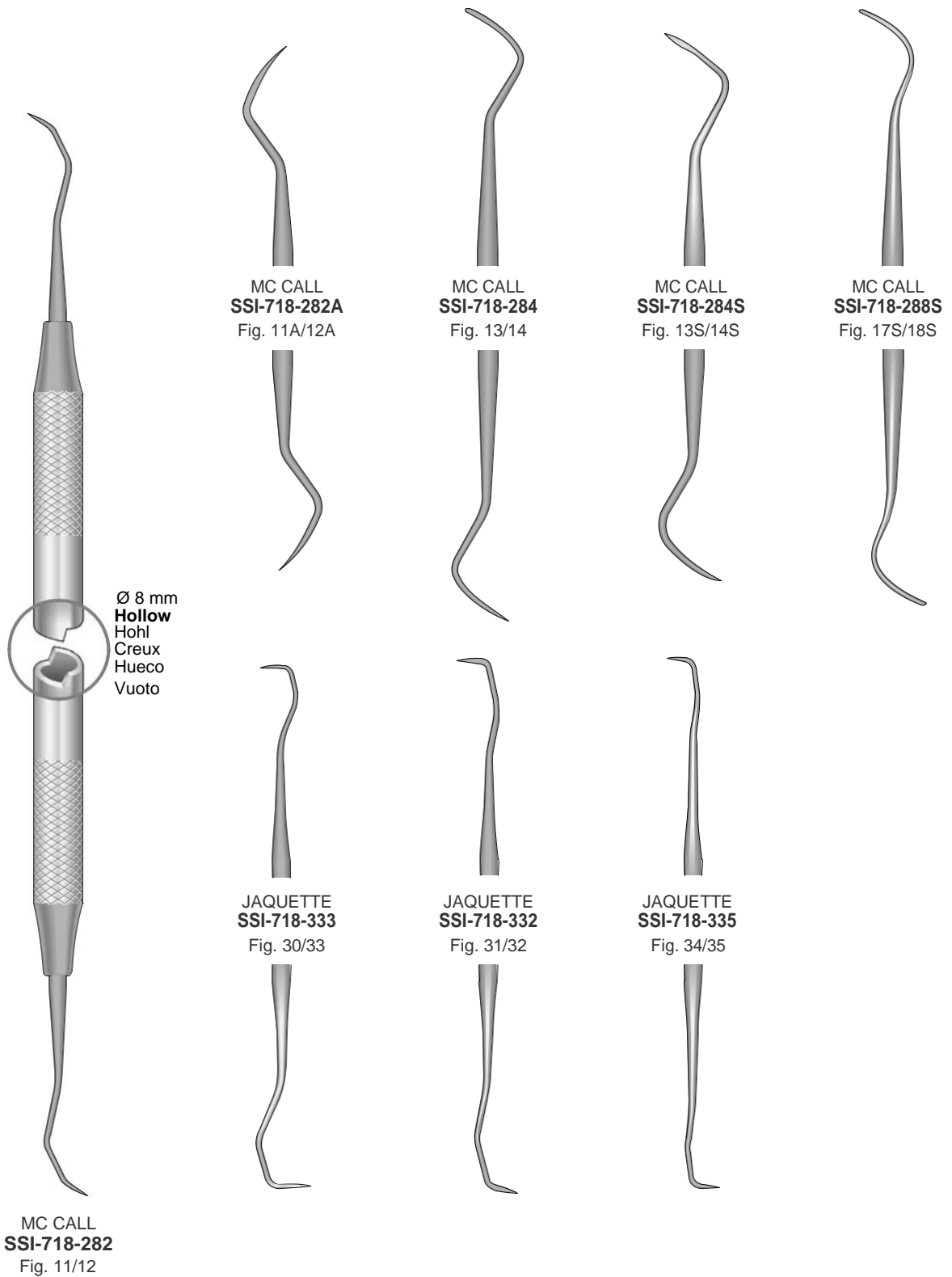
GOLDMAN-FOX
SSI-718-274
Fig. 4

GOLDMAN-FOX
SSI-718-275
Fig. 5

GOLDMAN-FOX
SSI-718-277
Fig. 21

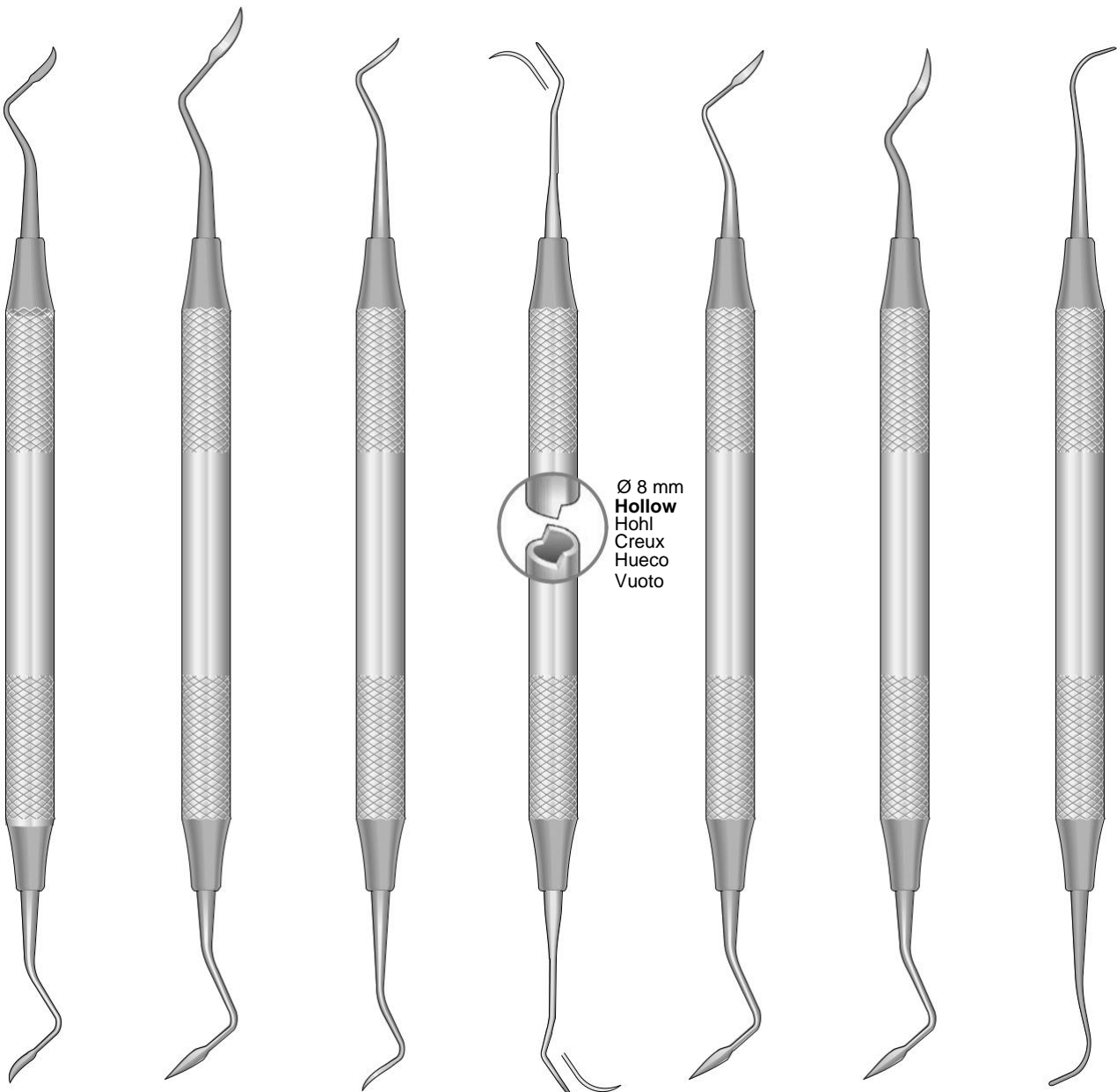
Email: sheffieldsurgicalinstruments@gmail.com
Web: www.sheffieldsurgicalinst.com

Scaler und Küretten
 Scalers and Curettes
 Scaler e Curette
 Raspadores y Curetas
 Détartreurs et Curettes





Scaler und Küretten
Scalers and Curettes
Scaler e Curette
Raspadores y Curetas
Détartreurs et Curettes



Ø 8 mm
Hollow
Hohl
Creux
Hueco
Vuoto

TAYLOR
SSI-718-T03
Fig. 2/3

SSI-718-204
Fig. 204

SSI-718-204S
Fig. 204S

SSI-718-204SD
Fig. 204SD

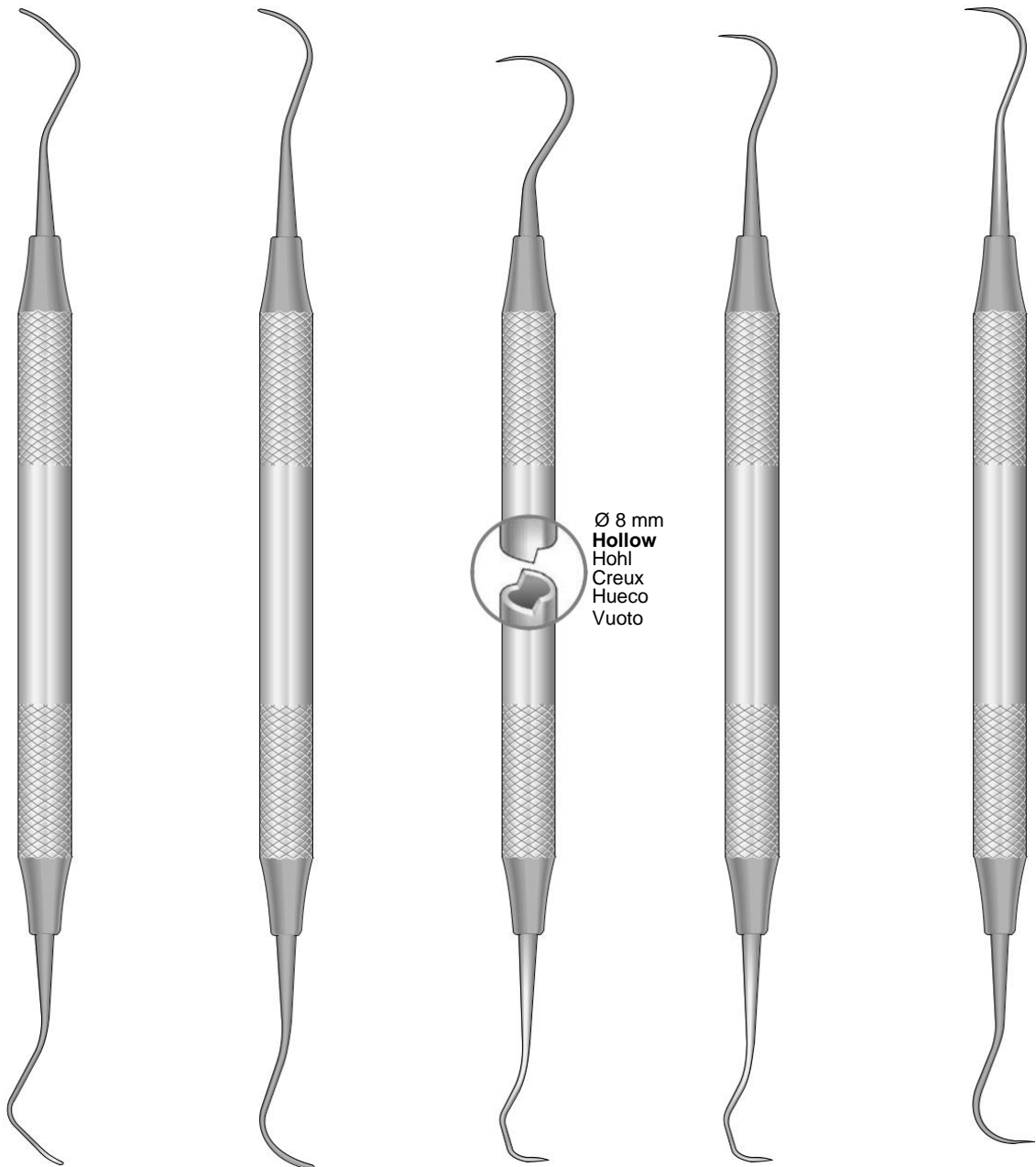
SSI-718-CIO3
Fig. 2/3

CRANE-CAPLAN
SSI-718-CK6
Fig. 6

YOUNGER-GOOD
SSI-718-YGO8
Fig. 7/8

Email: sheffieldsurgicalinstruments@gmail.com
Web: www.sheffieldsurgicalinst.com

Scaler und Küretten
 Scalers and Curettes
 Scaler e Curette
 Raspadores y Curetas
 Détartreurs et Curettes



Ø 8 mm
Hollow
 Hohl
 Creux
 Hueco
 Vuoto

RULE 23/24
 SSI-718-RO4
 Fig. 3 /4

I. UNIVERSITY
 SSI-718-268
 Fig. 17/18

TOWNER-JAQUETTE
 SSI-719-111
 Fig. U15/33

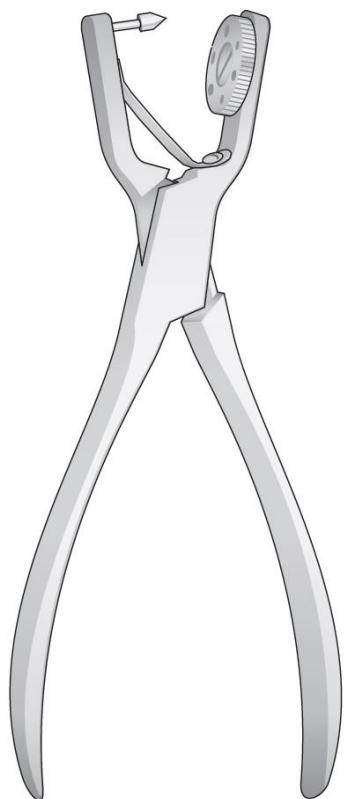
TOWNER-JAQUETTE
 SSI-719-125
 Fig. H5/33

TOWNER-JAQUETTE
 SSI-719-126
 Fig. H6/H7



Kofferdam Instrumente
Rubber-Dam Instruments
Strumenti per diga
Instrumentos para dique de goma

Instruments pour digue de caoutchouc



AINSWORTH
SSI-DF-02
160 mm



SSI-DF-02M

Feder mit Schraube
Spring with screw
Molla con vite
Muelle con tornillo
Ressort avec vis

SSI-DF-02R



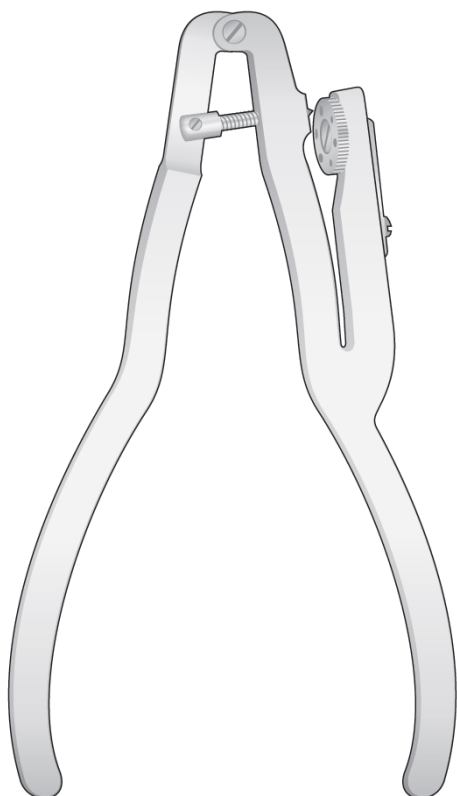
Lochscheibe
Punch Disk
Disco divisore
Disco agujereado
Disque perforé



SSI-DF-02P

Stift, mit Schraube
Pin, with screw
Perno con vite
Punzòn con perno
Broche

Lochzangen
Punch Forceps
Pinze foradiga
Perforadores
Pincas à perforer



IVORY
SSI-DF-00
160 mm



SSI-DF-00M

Spiralfeder
Spiral Spring
Molla a spirale
Muelle espiral
Ressort en spirale



SSI-DF-00L + SSI-DF-00V

Feder mit Schraube
Spring with screw
Molla con vite
Muelle con tornillo
Ressort avec vis



SSI-DF-00R

Lochscheibe
Punch Disk
Disco divisore
Disco agujereado
Disque perforé



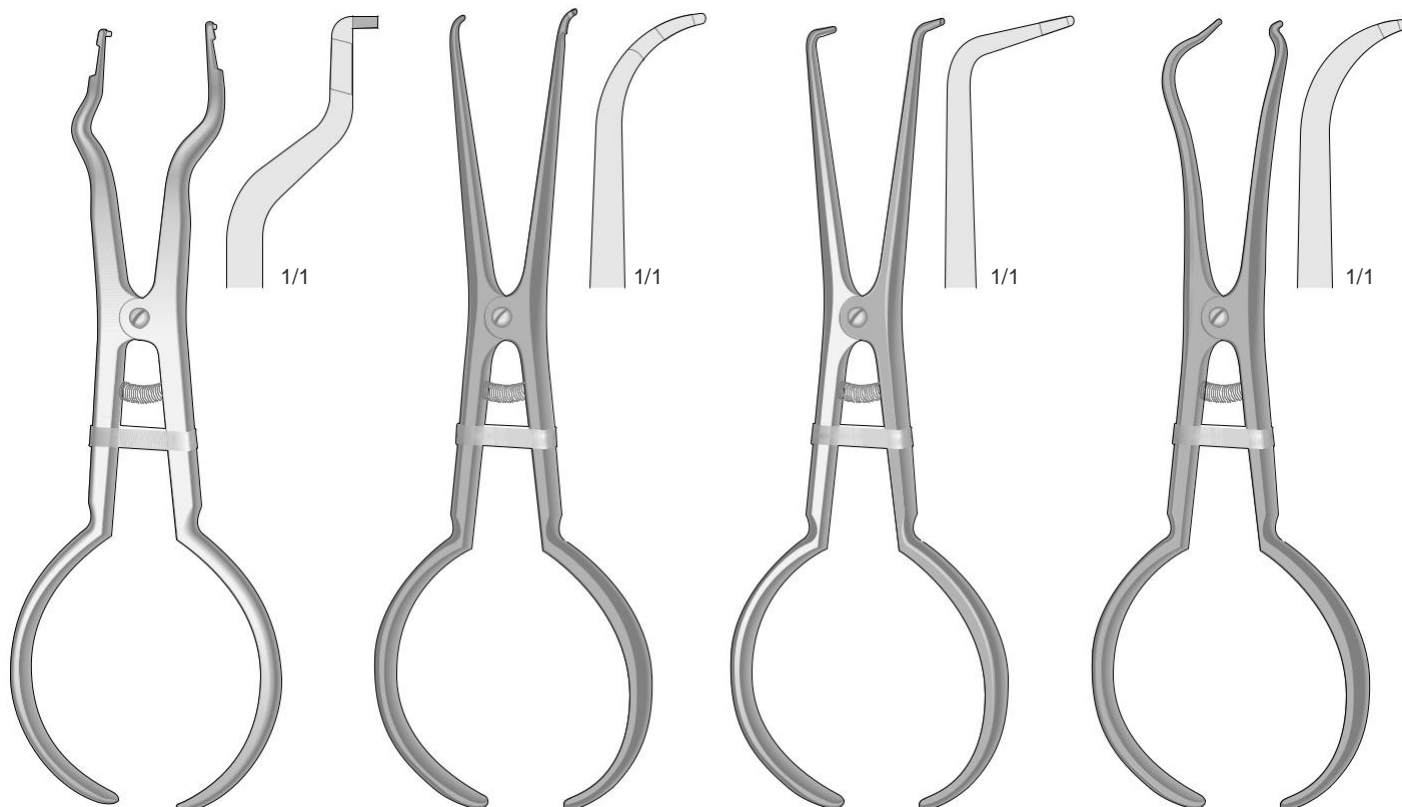
SSI-DF-00P + SSI-DF-00N

Stift, mit Schraube
Pin, with screw
Perno con vite
Punzòn con perno
Broche avec vis

Lochzangen
Punch Forceps
Pinze foradiga
Perforadores
Pincas à perforer

Email: sheffieldsurgicalinstruments@gmail.com
Web: www.sheffieldsurgicalinst.com

Kofferdam-Klammerzangen
Rubber-Dam Clamp Forceps
Pinze per uncini
Pinzas para grapas dique de goma
Pincés porte-crampons



BREWER
SSI-DF-10
170 mm

PALMER
SSI-DF-15
170 mm

STOKE
SSI-DF-16
170 mm

SSI-DF-18
170 mm

Email: sheffieldsurgicalinstruments@gmail.com
Web: www.sheffieldsurgicalinst.com



Matrizenspanner und Matrizenbänder
 Matrix Retainers and Matrix Bands
 Portamatrici e matrici
 Portamatrices y bandas matrices
 Porte-matrices et bagues matrices

Molaren, 12 Stück
 Molars, 12 pieces
 Molari, 12 pezzi
 Molares, 12 piezas
 Molaïres, 12 Pièces

Premolaren, 12 Stück
 Premolars, 12 pieces
 Premolari, 12 pezzi
 Premolares, 12 piezas
 Prémolaires, 12 Pièces

Kofferdam-Klammerzangen
 Rubber-Dam Clamp Forceps
 Pinze per uncini
 Pinzas para grapas dique de goma
 Pincés porte-crampons



SSI-DF-40/1
 Fig.1



SSI-DF-41/4
 Fig.4



SSI-DF-40/2
 Fig.2



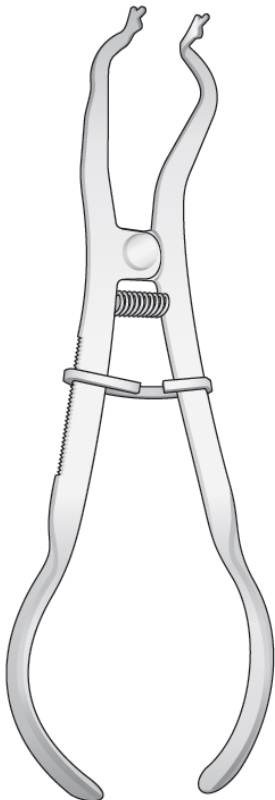
SSI-DF-41/5
 Fig.5



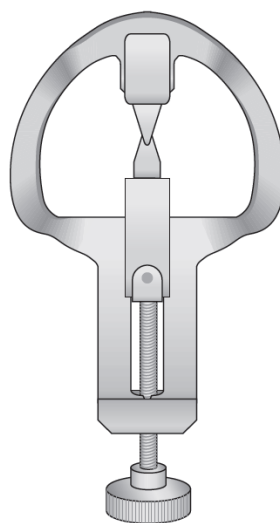
SSI-DF-40/3
 Fig.3



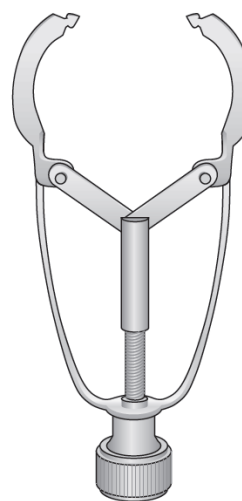
SSI-DF-41/6
 Fig.6



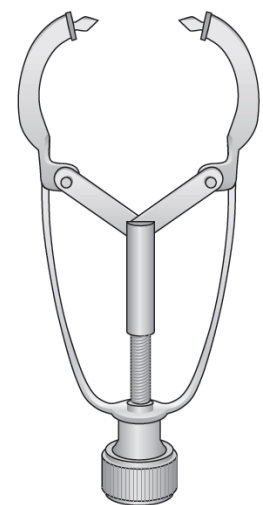
IVORY
SSI-DF-12
 170 mm



IVORY
SSI-DF-43
 Fig. 14



IVORY
SSI-DF-40
 Fig. 1



IVORY
SSI-DF-41
 Fig. 12

Email: sheffieldsurgicalinstruments@gmail.com
 Web: www.sheffieldsurgicalinst.com



Kofferdam Instrumente
 Rubber-Dam Instruments
 Strumenti per diga
 Instrumentos para dique de goma
 Instruments pour digue de caoutchouc

Kofferdam-Klammern
 Rubber-Dam Clamps
 Uncini per diga
 Clamps para diques
 Crampons pour digue



IVORY
SSI-DF-126
 # 26



IVORY
SSI-DF-127
 # 27



IVORY
SSI-DF-128
 # 28



IVORY
SSI-DF-129
 # 29



IVORY
SSI-DF-130
 # 30



IVORY
SSI-DF-131
 # 31

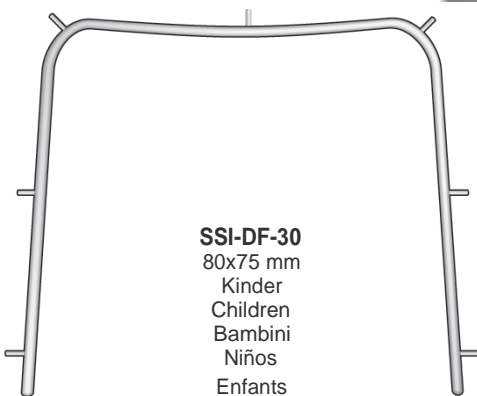


IVORY
SSI-DF-151
 # 51

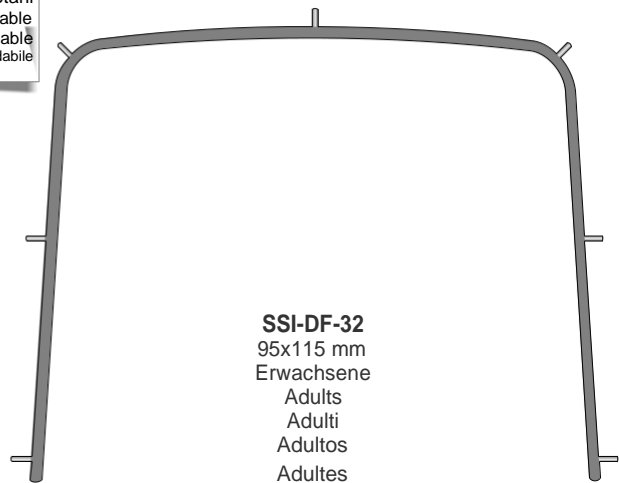


IVORY
SSI-DF-160
 # 60

Kofferdam-Rahmen
 Rubber-Dam Frames
 Telaio per diga
 Cuadro para diques
 Cadre à digue



SSI-DF-30
 80x75 mm
 Kinder
 Children
 Bambini
 Niños
 Enfants



SSI-DF-32
 95x115 mm
 Erwachsene
 Adults
 Adulti
 Adultos
 Adultes

Email: sheffieldsurgicalinstruments@gmail.com
 Web: www.sheffieldsurgicalinst.com



Matrizenspanner und Matrizenbänder
 Matrix Retainers and Matrix Bands
 Portamatrici e matrici
 Portamatrices y bandas matrices
 Porte-matrices et bagues matrices

Molaren, 12 Stück
 Molars, 12 pieces
 Molari, 12 pezzi
 Molares, 12 piezas
 Molaires, 12 Pièces

Premolaren, 12 Stück
 Premolars, 12 pieces
 Premolari, 12 pezzi
 Premolares, 12 piezas
 Prémolaires, 12 Pièces

TOFFLEMIRE
 Universal



SSI-DF-03/7
 #7



SSI-DF-03/11
 #11



SSI-DF-03/1
 #1



SSI-DF-03/8
 #8



SSI-DF-03/12
 #12



SSI-DF-03/2
 #2



SSI-DF-03/9
 #9



SSI-DF-03/13
 #13



SSI-DF-03/3
 #3



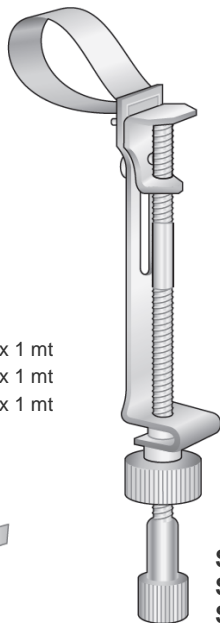
SSI-DF-03/10
 #10



SSI-DF-01/5 5 mm x 1 mt
SSI-DF-01/6 6 mm x 1 mt
SSI-DF-01/7 7 mm x 1 mt



SSI-DF-05/5 5 mm x 5 mt
SSI-DF-05/6 6 mm x 5 mt
SSI-DF-05/7 7 mm x 5 mt



SSI-DF-06 5 mm
SSI-DF-08 6 mm
SSI-DF-09 7 mm

IVORY
SSI-DF-06/SSI-DF-09
 #8

Paar - Pair
 Coppia - Par
 Paire

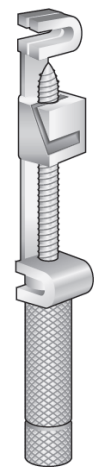


#1
 Right
 Destra
 Derecha
 Droite



#2
 Left
 Sinistra
 Izquierda
 Gauche

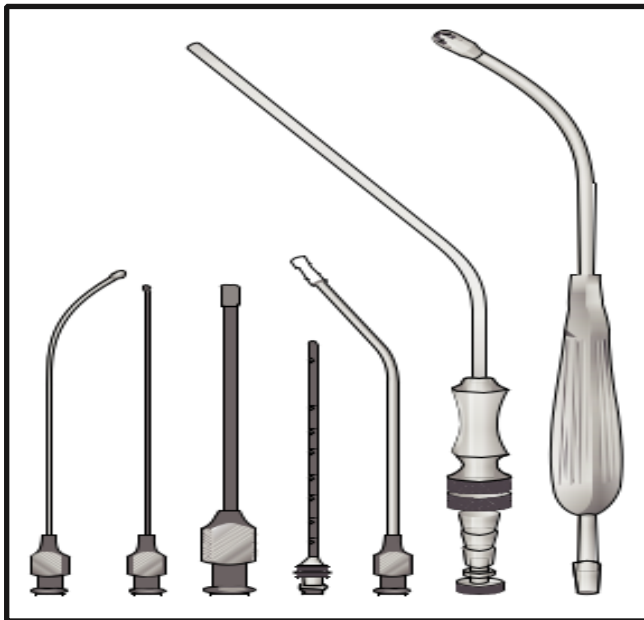
NYSTRÖM
SSI-DF-04
 #1 + #2



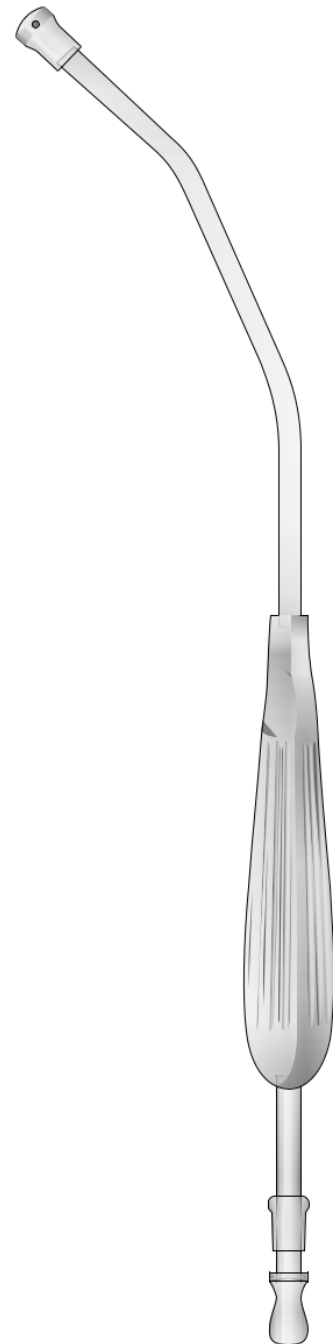
TOFFLEMIRE
SSI-DF-07
 Universal

Email: sheffieldsurgicalinstruments@gmail.com
 Web: www.sheffieldsurgicalinst.com

Suction Tubes
Saugkanülen
Canules d'aspiration
Cánulas de aspiración
Cannule per aspirazione

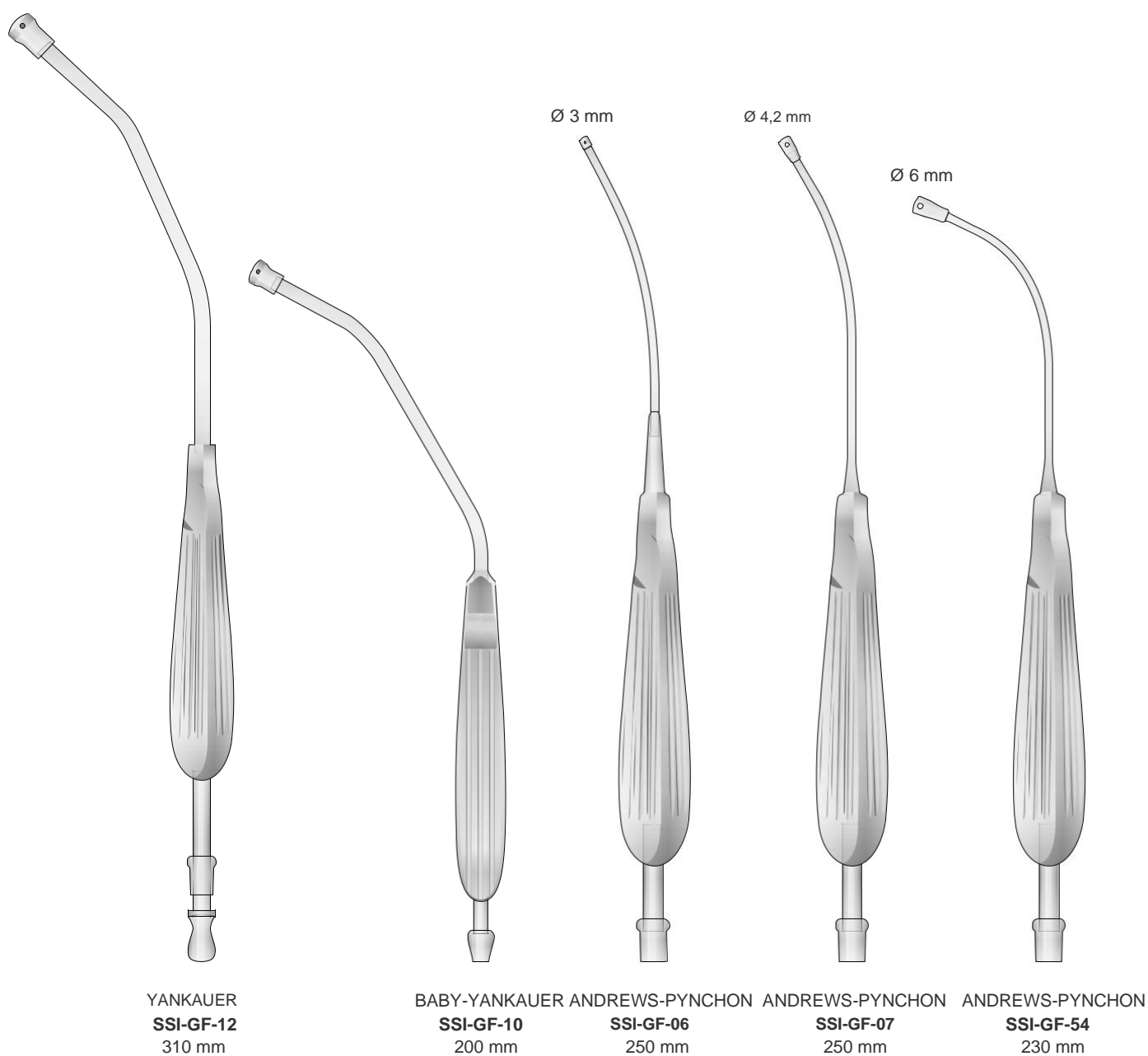


Sheffield Surgical is highly experienced Manufacturer & exporter of high quality Dental Instruments and also in the field of General Surgery, Bone Surgery an Orthopedic Instruments.



Saugkanülen
Suction Tubes
Cannule per aspirazione
Cánulas de aspiración
Canules d'aspiration

Stainless Steel
Rostfreier Stahl
Acier inoxydable
Acero inoxidable
Acciaio inossidabile



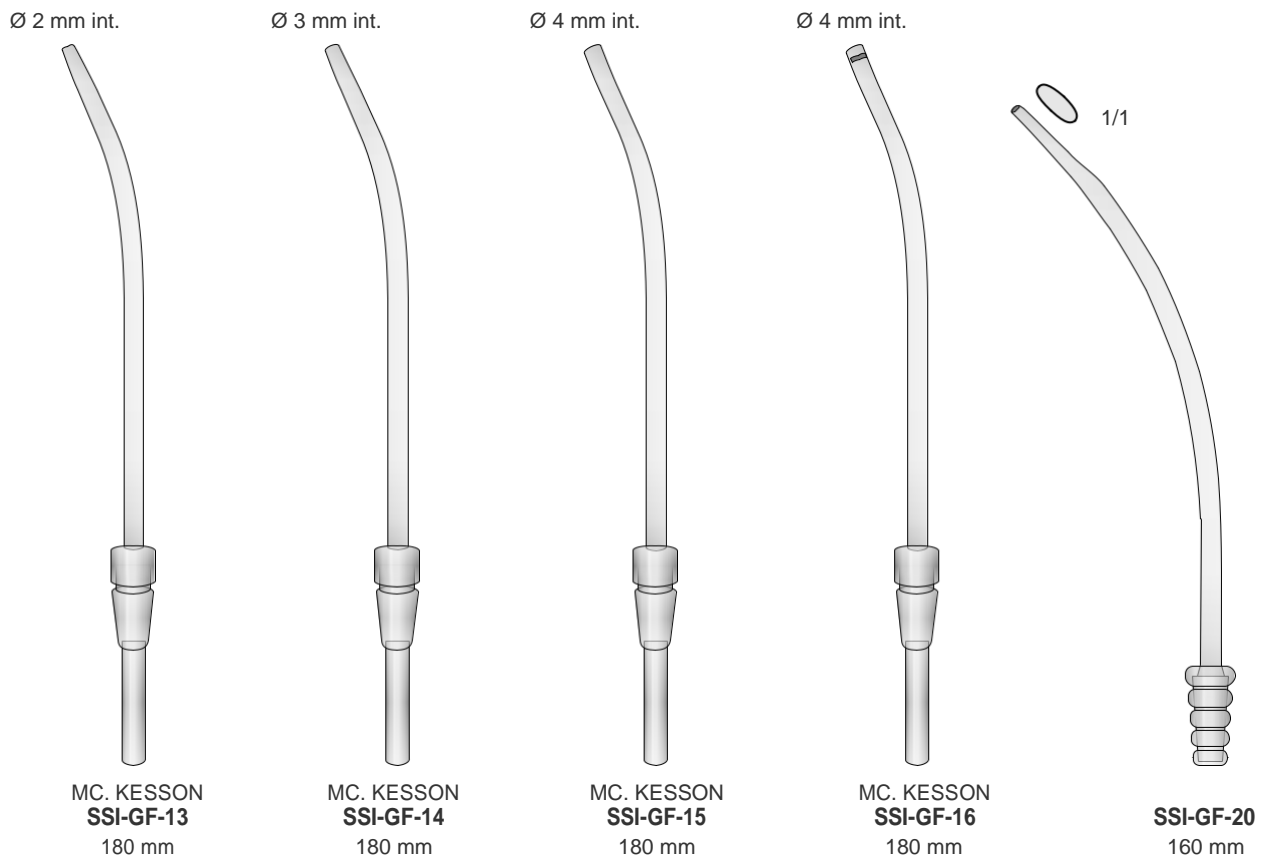
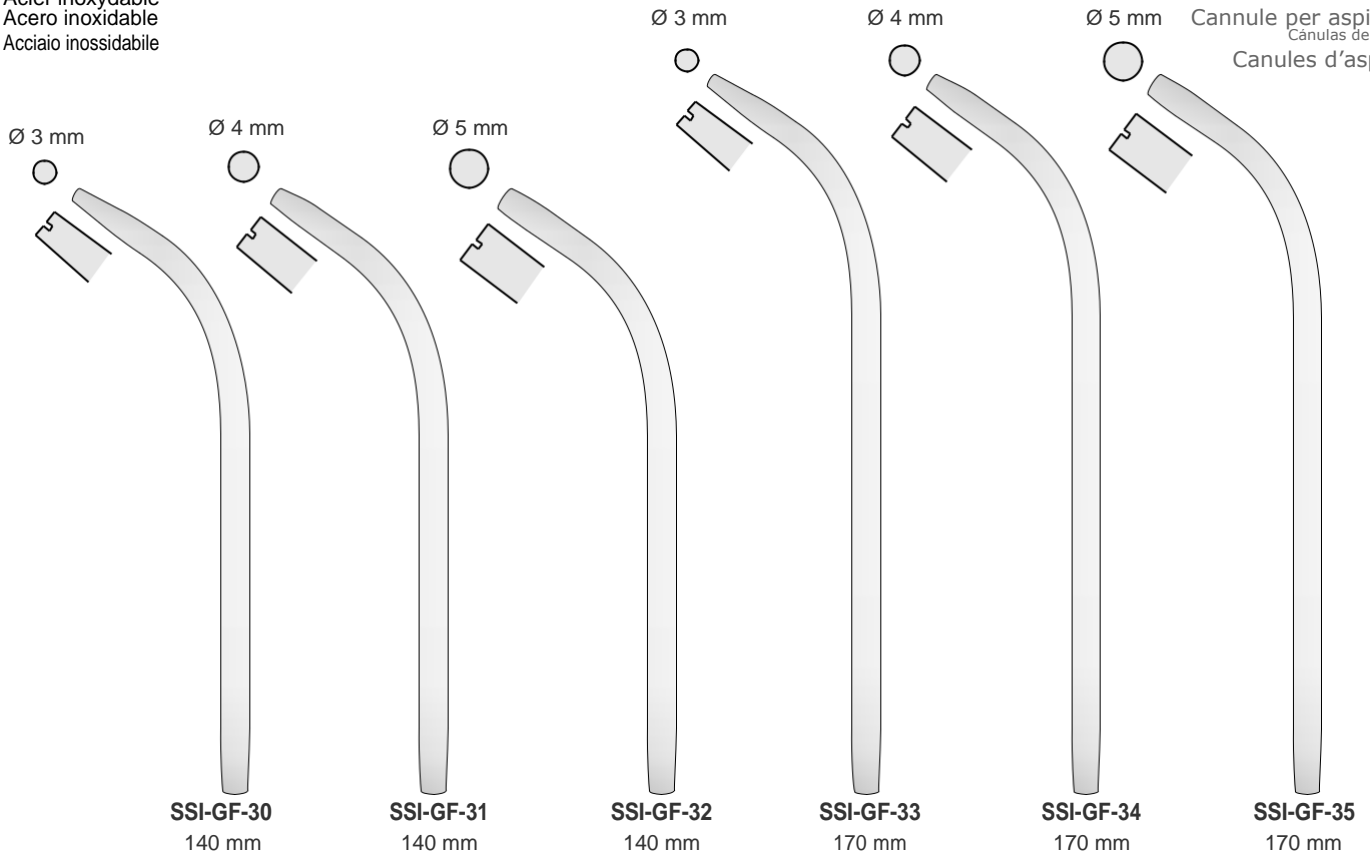
Email: sheffieldsurgicalinstruments@gmail.com
Web: www.sheffieldsurgicalinst.com



Stainless Steel
Rostfreier Stahl
Acier inoxydable
Acero inoxidable
Acciaio inossidabile

Saugkanülen
Suction Tubes

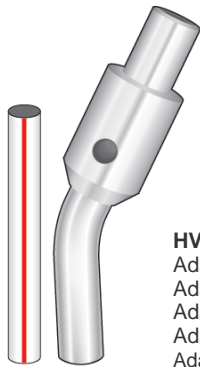
Cannule per aspirazione
Cánulas de aspiración
Canules d'aspiration



Email: sheffieldsurgicalinstruments@gmail.com
Web: www.sheffieldsurgicalinst.com

Saugkanülen
Suction Tubes
Cannule per aspirazione
Cánulas de aspiración
Canules d'aspiration

Stainless Steel
Rostfreier Stahl
Acier inoxydable
Acero inoxidable
Acciaio inossidabile



SSI-TS-40
Connection piece for suction
75 mm - 100% Stainless Steel



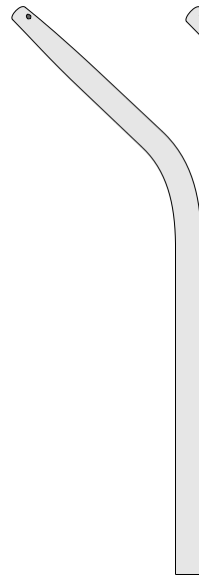
COUPLAND
SSI-GF-01
150 mm

Ø 1 mm

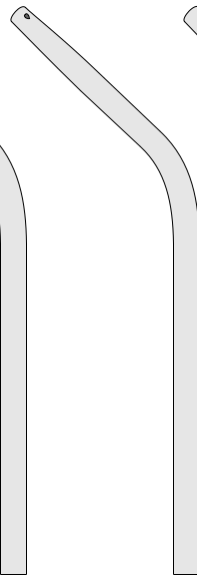
Ø 1,5 mm

Ø 2,5 mm

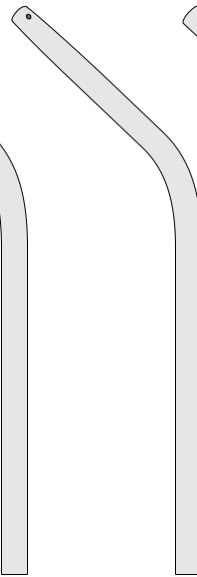
Ø 3,5 mm int.



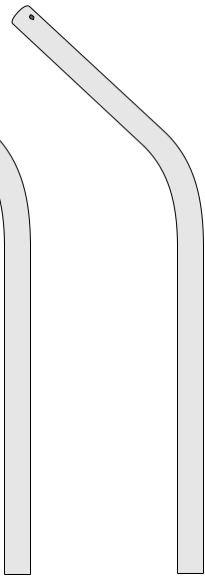
SSI-GF-05
95 mm



SSI-GF-04
95 mm



SSI-GF-03
95 mm



SSI-GF-02
95 mm

COMPLETE SET
SSI-GF-11

(SSI-GF-01 + SSI-GF-02 + SSI-GF-03
+ SSI-GF-04 + SSI-GF-05)
Griff + 4 Kanülen
Handle + 4 tubes
Manico + 4 cannule
Mango + 4 cánulas
Manche + 4 canules



SSI-GF-271
56 mm

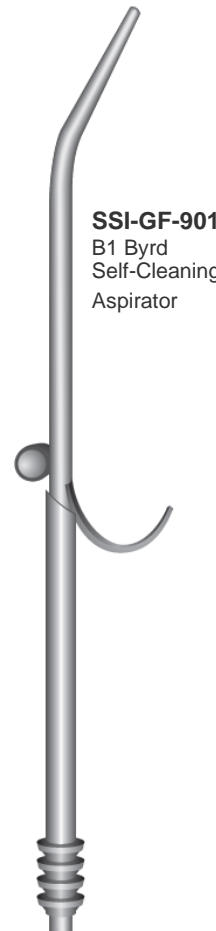
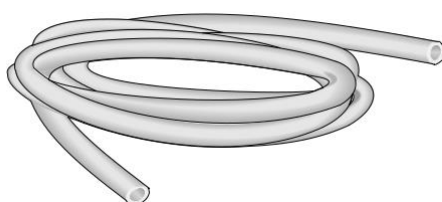
Adaptor
Adapter
Adattatore
Adaptador
Adaptateur

Ø Ext. 6,0 mm
Ø Int. 4,5 mm

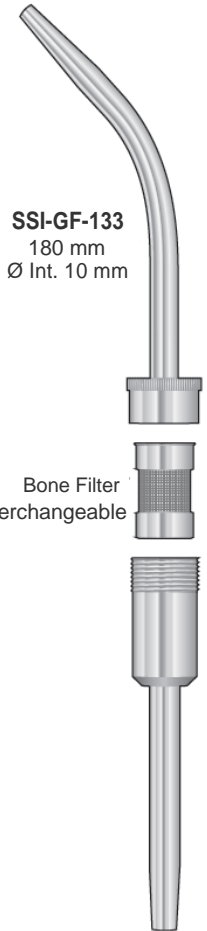
Autoclavable Tubing

Schlauch - Silikon
Flexible Tube - Silicone
Raccordo in silicone per cannule
Tubo flexible de silicona
Tuyau - Silicone

SSI-TS-50
2 m



SSI-GF-901
B1 Byrd
Self-Cleaning
Aspirator



SSI-GF-133
180 mm
Ø Int. 10 mm
Bone Filter
interchangeable



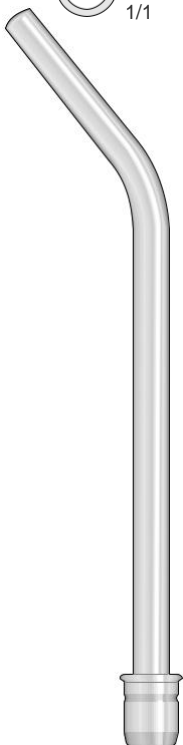
Saugkanülen
Suction Tubes
Cannule per aspirazione
Cánulas de aspiración
Canules d'aspiration

Stainless Steel
Rostfreier Stahl
Acier inoxydable
Acero inoxidable
Acciaio inossidabile

Ø Est. 8 mm
Ø Int. 6 mm



1/1

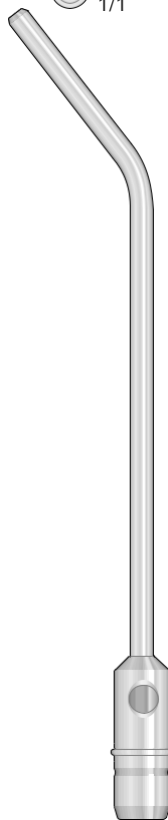


PELTON-CRANE
SSI-GF-184
140 mm

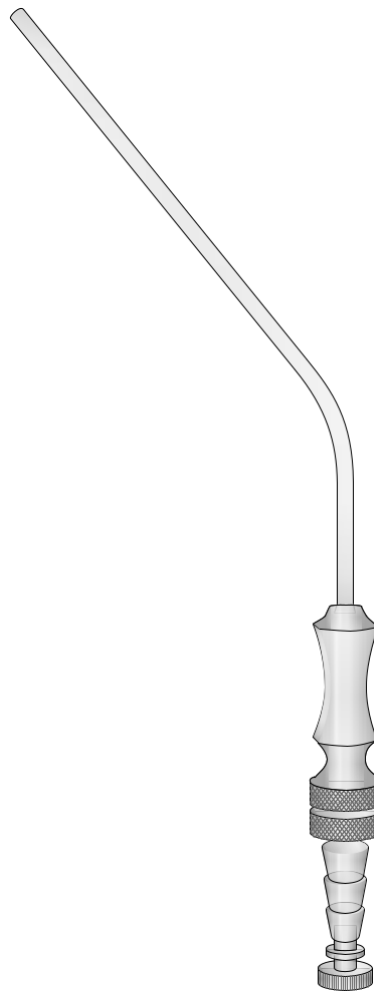
Ø Est. 5 mm
Ø Int. 2,5 mm



1/1



PELTON-CRANE
SSI-GF-180
160 mm



FRAZIER
SSI-GF-240/SSI-GF-244
180 mm

| | | |
|--------------------|--------|--------|
| SSI-GF-240 | Ch. 6 | 2.0 mm |
| SSI-GF-241 | Ch. 7 | 2.3 mm |
| SSI-GF-241B | Ch. 8 | 2.5 mm |
| SSI-GF-242 | Ch. 9 | 3.0 mm |
| SSI-GF-242B | Ch. 10 | 3.3 mm |
| SSI-GF-243 | Ch. 12 | 4.0 mm |
| SSI-GF-244 | Ch. 15 | 5.0 mm |

Email: sheffieldsurgicalinstruments@gmail.com
Web: www.sheffieldsurgicalinst.com

Saugkanülen
Suction Tubes
Cannule per aspirazione
Cánulas de aspiración
Canules d'aspiration

Stainless Steel
Rostfreier Stahl
Acier inoxydable
Acero inoxidable
Acciaio inossidabile



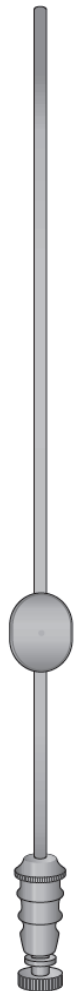
WERTHEIMER
SSI-GF-69
160 mm

Flexible
Flexibel
Flexible
Flexible
Flessibile
Ø 3 mm



FRAZIER
SSI-GF-70
160 mm

Chromium Black
Schwarz-Chrom
Chrome noir
Cromado negro
Cromato nero

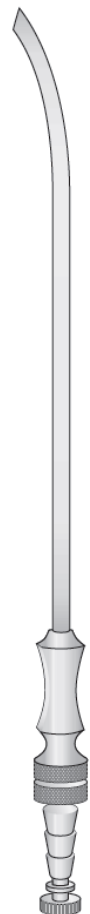


FRAZIER
SSI-GF-61
200 mm

Flexible
Flexibel
Flexible
Flexible
Flessibile
Ø 3 mm



WERTHEIMER
SSI-GF-60
200 mm



ADSON
SSI-GF-41 ch. 12 Ø 4 mm
SSI-GF-42 ch. 15 Ø 5 mm
210 mm

Email: sheffieldsurgicalinstruments@gmail.com
Web: www.sheffieldsurgicalinst.com



Kanülenreinigungs-Bürsten
Cleaning brush for Tubes
Scovolini per pulizia cannule
Cepillo para limpiar cánulas
Brosse de nettoyage pour canules



Bürsten
Brush
Spazzola
Cepillo
Brosse

Autoklav
Autoclavable
Autoclavabile
Autoclave
Autoclave

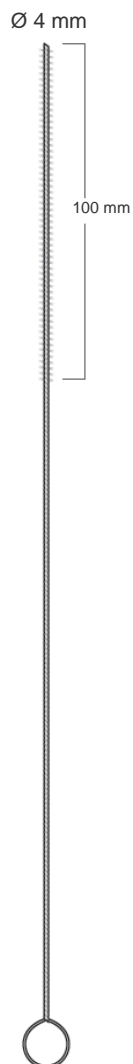
SSI-GF-200
4 x 11 cm



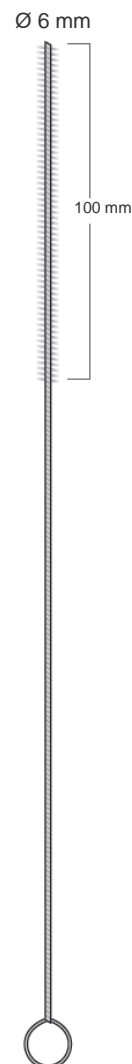
SSI-GF-40
235 mm



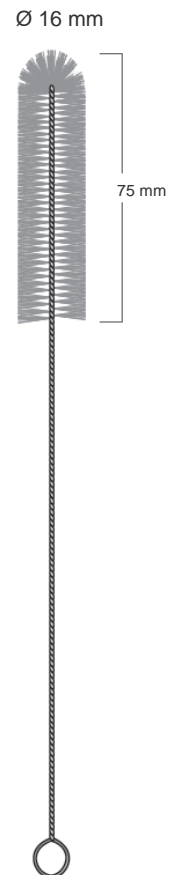
SSI-GF-182
215 mm



SSI-GF-183
300 mm



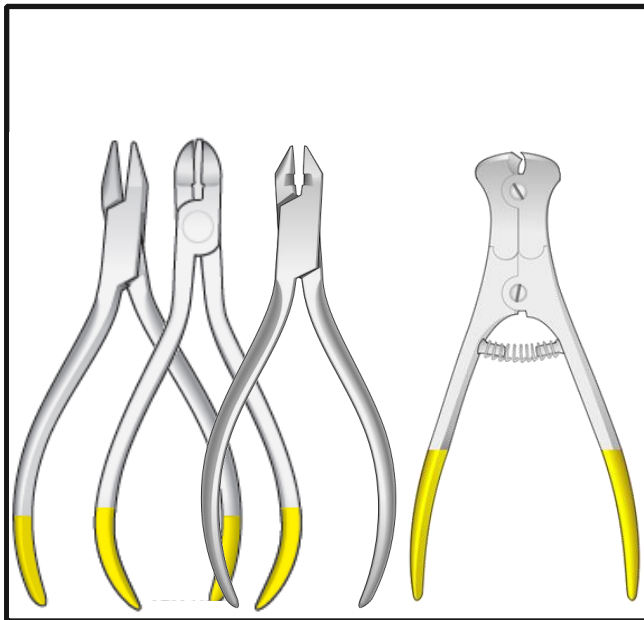
SSI-GF-185
300 mm



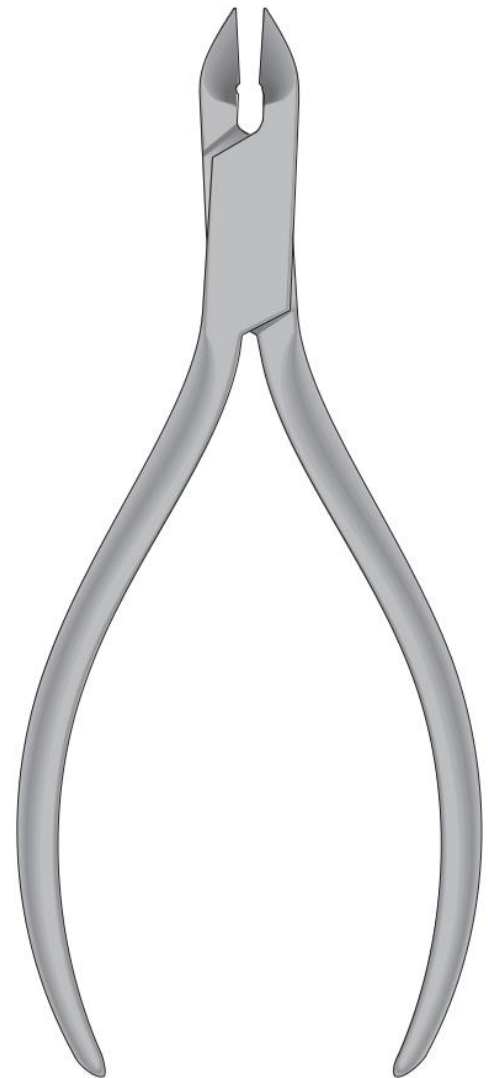
SSI-GF-188
220 mm

Email: sheffieldsurgicalinstruments@gmail.com
Web: www.sheffieldsurgicalinst.com

Orthodontics
Kieferorthopädie
Orthodontie
Ortodoncia
Ortodonzia

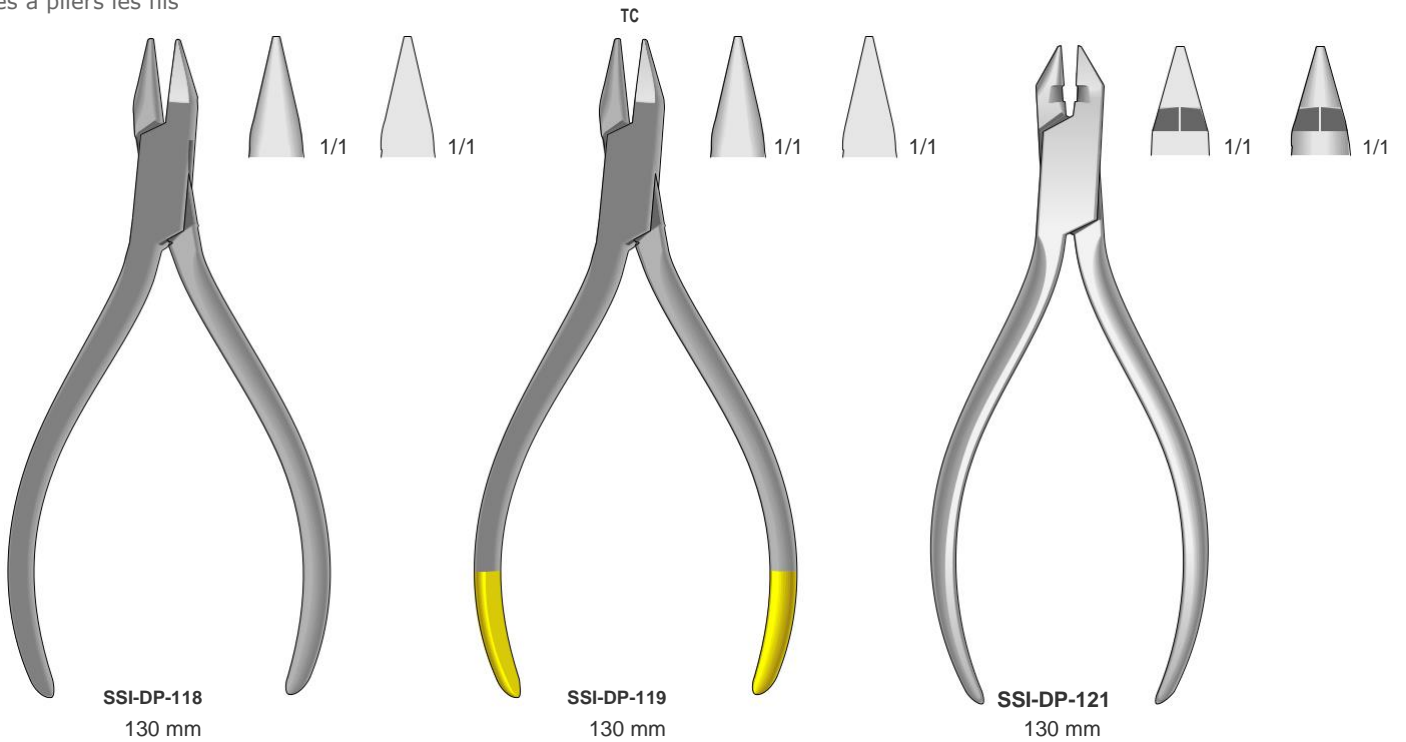


Sheffield Surgical is highly experienced Manufacturer & exporter of high quality Dental Instruments and also in the field of General Surgery, Bone Surgery an Orthopedic Instruments.

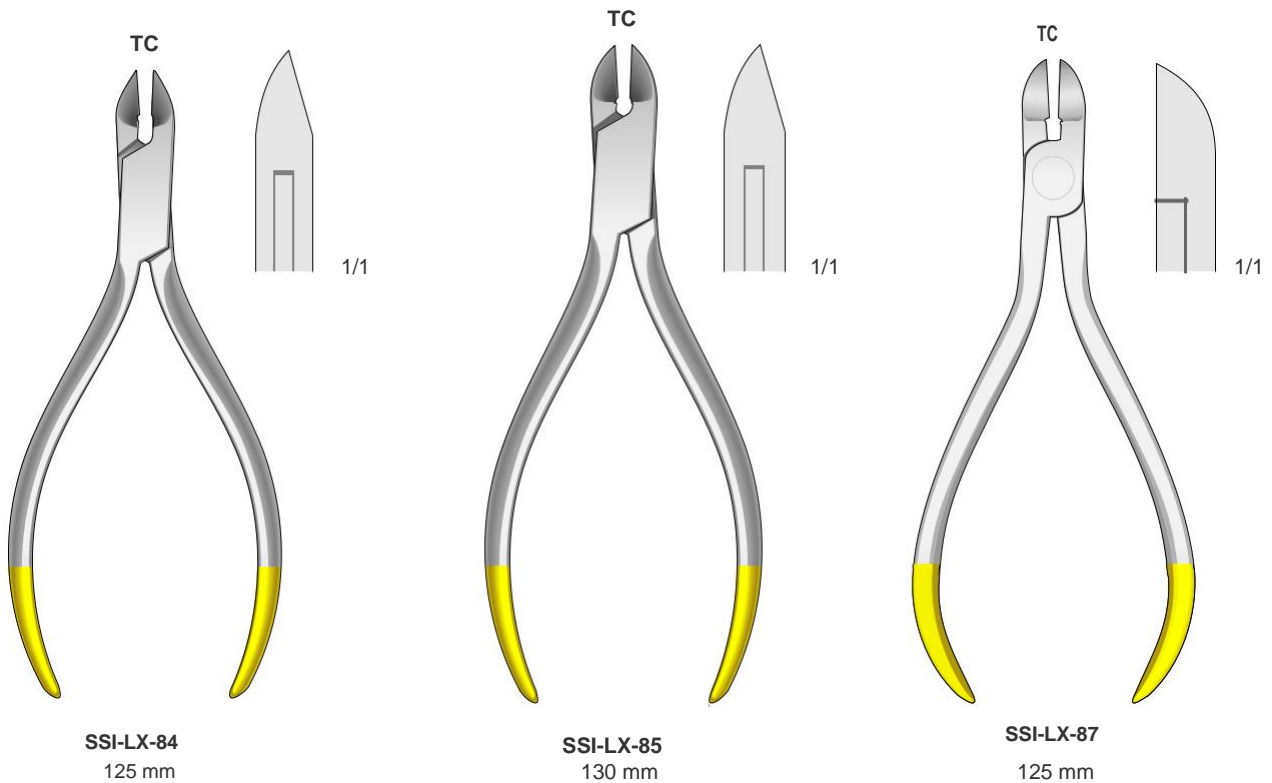


Email: sheffieldsurgicalinstruments@gmail.com
Web: www.sheffieldsurgicalinst.com

Drahtbiegezangen
 Wire Bending Pliers
 Pinze per piegare fili
 Alicates para doblar alambres
 Pincès à pliers les fils



Tungsten-Carbide Inserts
 Mit Hartmetalleinsätzen
 Plaquettes en carbure de tungstène
 Plaquetas de carburo de tungsteno
 Inserti in carburo di tungsteno



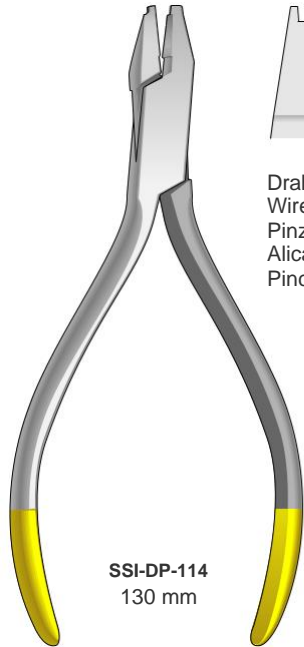
Email: sheffieldsurgicalinstruments@gmail.com
 Web: www.sheffieldsurgicalinst.com



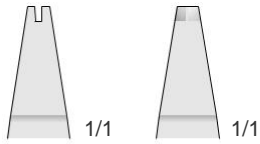
Drahtbiegeezangen
Wire Bending Pliers
Pinze per piegare fili
Alicates para doblar alambres

TC

 1/1

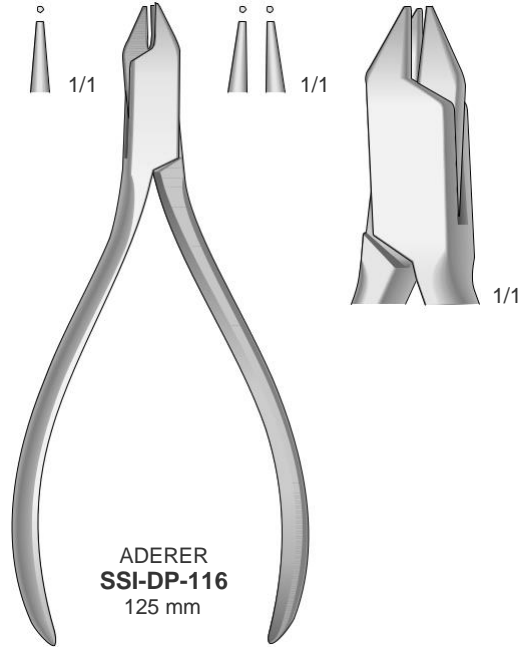


SSI-DP-114
130 mm

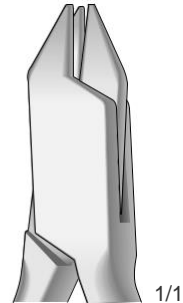


Drahtbiegeezangen
Wire Bending Pliers
Pinze per piegare fili
Alicates para doblar alambres
Pincers à pliers les fils

Mod. Medium Pincers à pliers les fils Mod. Medio

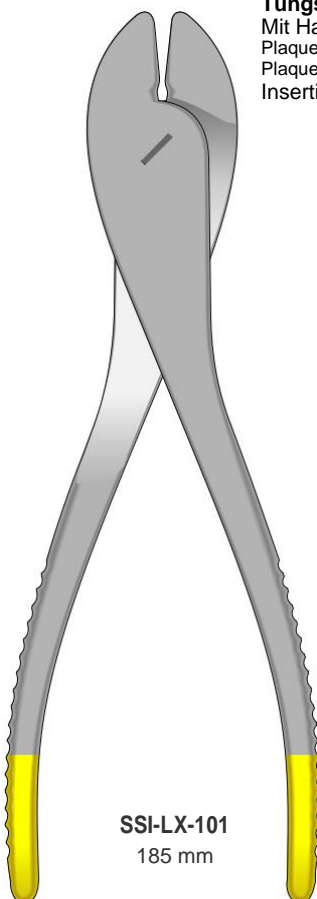


ADERER
SSI-DP-116
125 mm



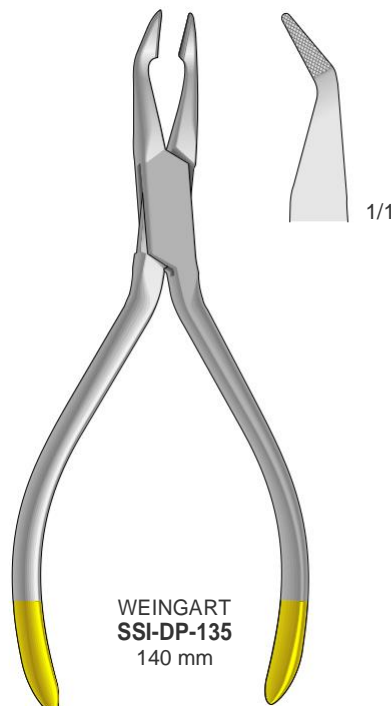
TC

Tungsten-Carbide Inserts
Mit Hartmetalleinsätzen
Plaquettes en carbure de tungstène
Plaquetas de carburo de tungsteno
Inserti in carburo di tungsteno

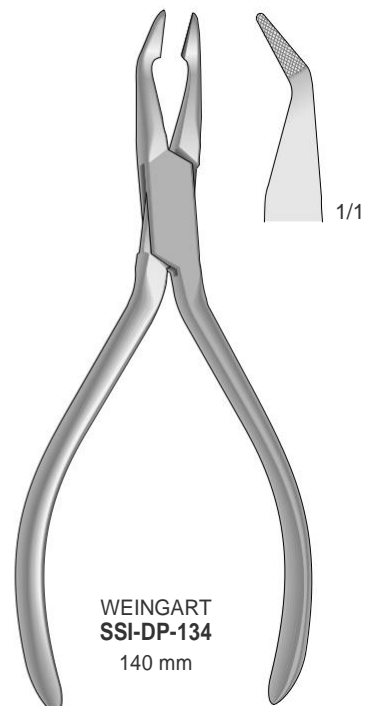


SSI-LX-101
185 mm

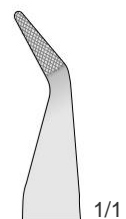
TC



WEINGART
SSI-DP-135
140 mm

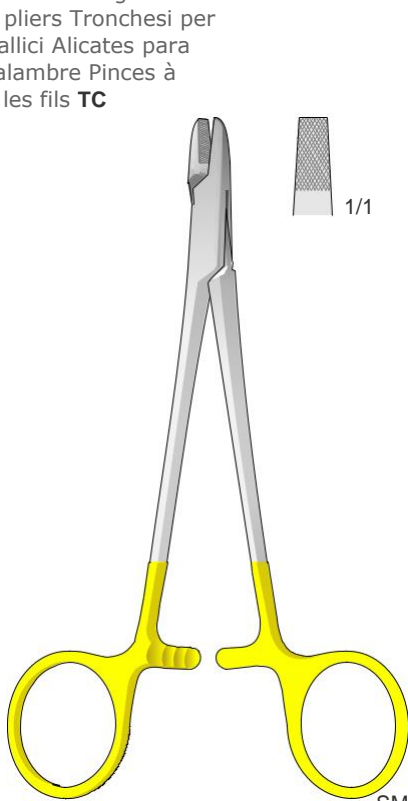


WEINGART
SSI-DP-134
140 mm

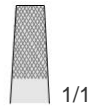


Email: sheffieldsurgicalinstruments@gmail.com
Web: www.sheffieldsurgicalinst.com

Drahtschneidezangen Wire cutting pliers Tronchesi per fili metallici Alicates para cortar alambre Pincas à couper les fils **TC**

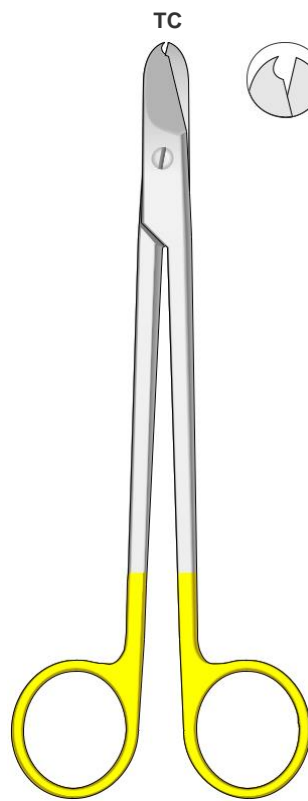


SSI-PH-58
150 mm

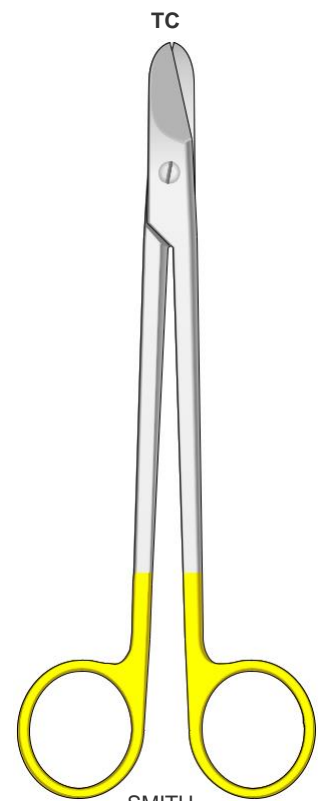


1/1

SMITH
SSI-FG-161

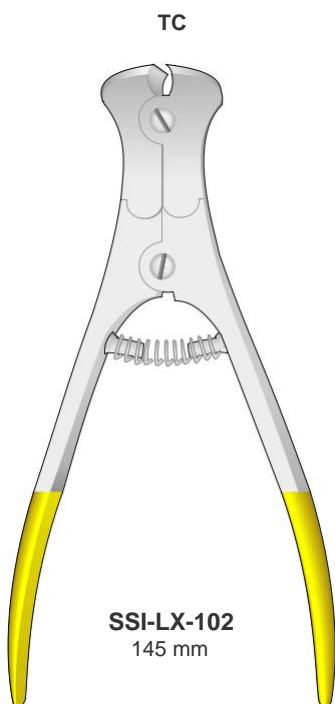


160 mm

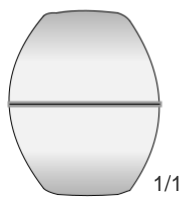


SMITH
SSI-FG-160
160 mm

Tungsten-Carbide Inserts Mit
Hartmetalleinsätzen Plaquettes en carbure de tungstène Plaquetas de carburo de tungsteno
Inserti in carburo di tungsteno



SSI-LX-102
145 mm



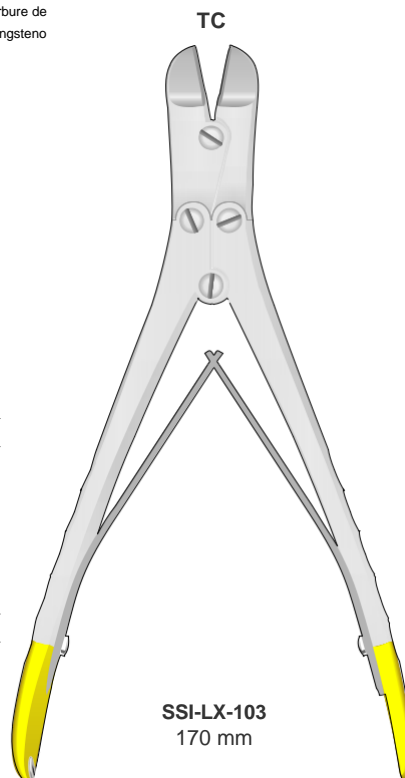
1/1

○ Max Ø 2.0 mm (.078")

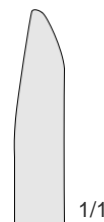
Für weichen Draht
For soft Wire
Per filo leggero
Para alambre blando
Pour fil léger

○ Max Ø 1.5 mm (.059")

Für harten Draht
For hard Wire
Per filo duro
Para alambre duro
Pour fil dur



SSI-LX-103
170 mm



1/1

○ Max Ø 2.0 mm (.078")

Für weichen Draht
For soft Wire Per filo
leggero Para
alambre blando Pour
fil léger

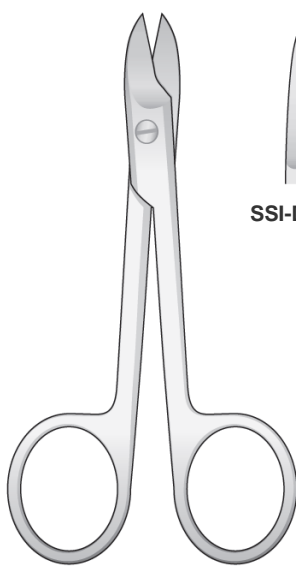
○ Max Ø 1.5 mm (.059")

Für harten Draht
For hard Wire
Per filo duro
Para alambre duro
Pour fil dur



Scheren
Scissors
Forbici
Tijeras
Ciseaux

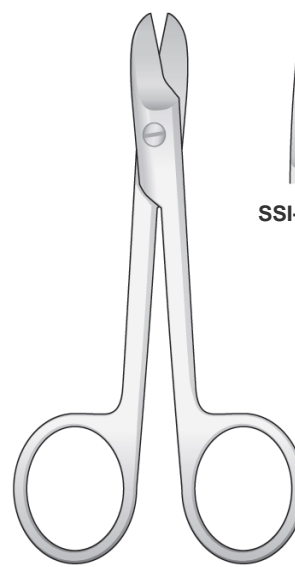
Scheren für dünne Stahl-und Edelmetallbleche - Scissors for thin steel and precious metal sheets
Forbici per lamine sottili di acciaio e metalli preziosi - Tijeras para láminas delgadas de acero y metales preciosos
Ciseaux pour couper les feuilles de métaux



BEEBE
SSI-DP-91/SSI-DP-92
110 mm



Spitz
Sharp
Acute
Aguda
Pointu

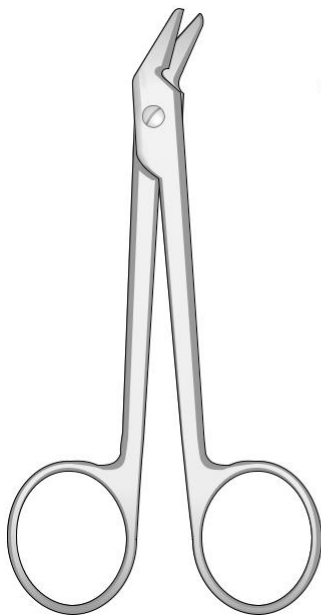


BEEBE
SSI-DP-102/SSI-DP-103
110 mm



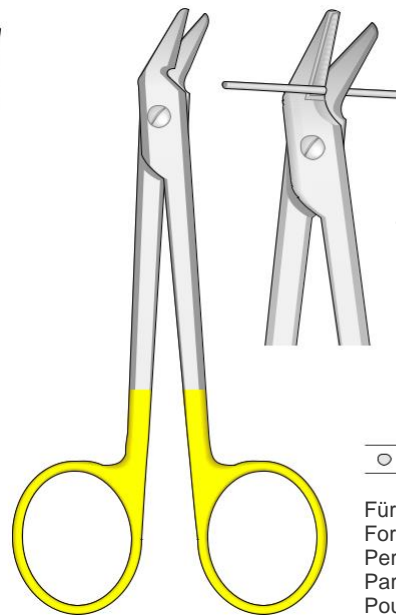
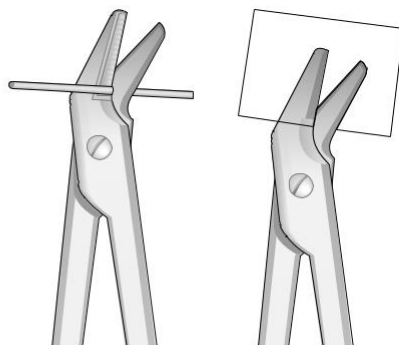
Stumpf
Blunt
Smusse
Roma
Mousse

Scheren für dünne Stahl-und Edelmetallbleche - Scissors for thin steel and precious metal sheets
Forbici per lamine sottili di acciaio e metalli preziosi - Tijeras para láminas delgadas de acero y metales preciosos
Ciseaux pour couper les feuilles de métaux



SSI-DP-90
120 mm

Draht-und Blechschere gezahnt
Wire cutting scissor serrated
Forbice universale dentellata
Tijeras para cortar hilo
de acero dentadas
Coupe-fils dentelé



SSI-DP-120
120 mm

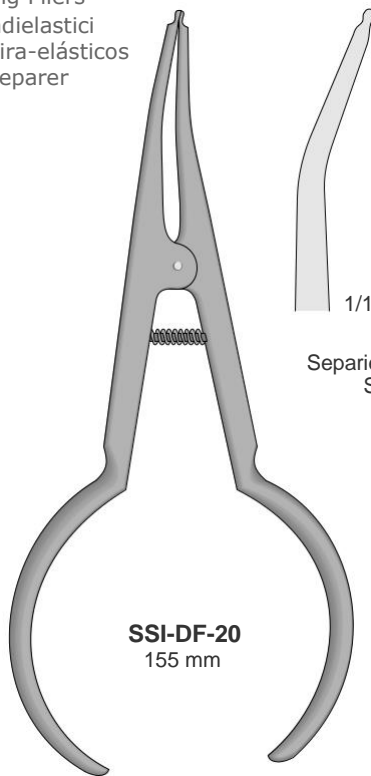
Tungsten-Carbide Inserts
Mit Hartmetalleinsätzen
Plaquettes en carbure de tungstène
Plaquetas de carburo de tungsteno
Inserti in carburo di tungsteno

○ Max Ø 1.2 mm (.048")

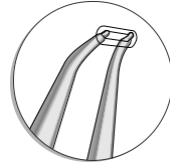
Für weichen Draht
For soft Wire
Per filo leggero
Para alambre blando
Pour fil léger

Email: sheffieldsurgicalinstruments@gmail.com
Web: www.sheffieldsurgicalinst.com

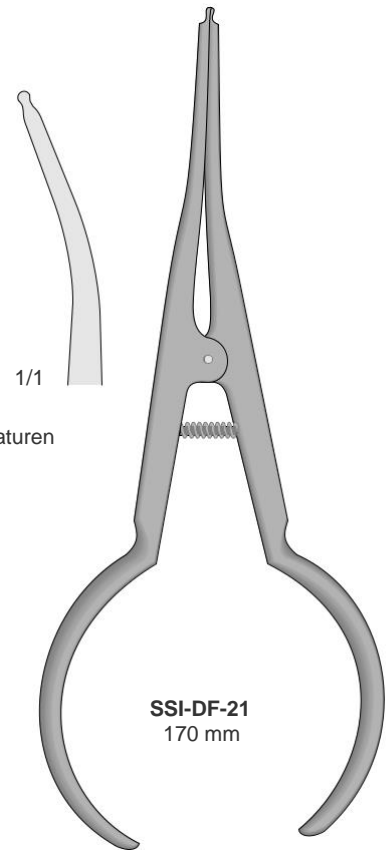
Separierzangen
Separating Pliers
Pinze tendielastici
Pinza estira-elásticos
Pince à separer



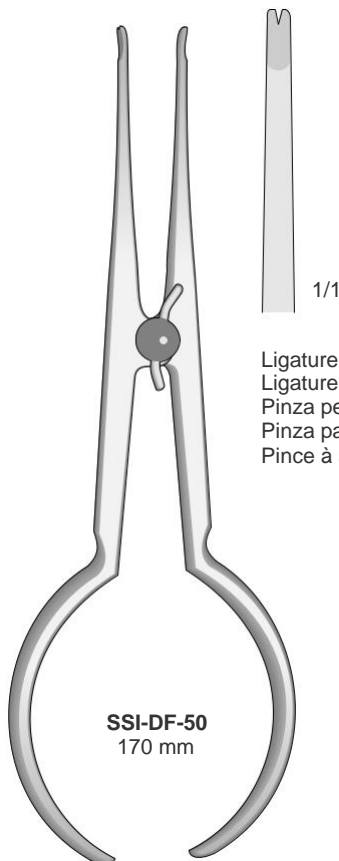
SSI-DF-20
155 mm



Separierzange, zum Einbringen von Gummi-Separierligaturen
Separating forceps for inserting elastic separators
Pinza per legature per separatori elastici
Pinza para ligaduras estira-elásticos
Pince à separer les ligatures



SSI-DF-21
170 mm



SSI-DF-50
170 mm

Ligaturenspannzange
Ligature Tying Plier
Pinza per legature
Pinza para ligaduras
Pince à serrer les ligatures



SSI-DP-150
160 mm

Bracketset Pinzette
Bonding Bracket Forceps
Pinzette per brackets
Pinza fina para ligar brackets
Fine pince à lier des boîtiers

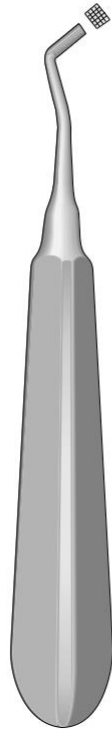
5.0
4.0
0



Aluminium
Aluminium
Aluminium
Aluminio
Alluminio

SSI-DP-100
170 mm

Bracketpositioner
Bracket Positioning Gauge
Posizionatore per attacchi
Posicionador de Brackets
Positionateur des Brackets



Gezahnt
Serrated
Dentellato
Dentado
Dentelé

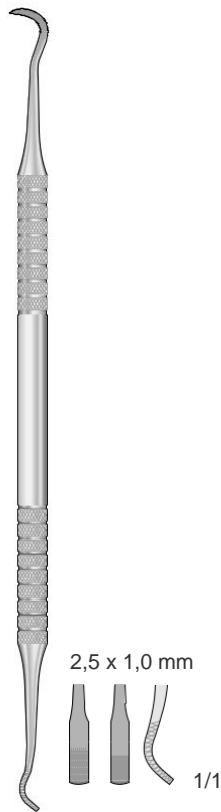
MERSHON
SSI-DP-50
140 mm

Verbandschieber
Band Pusher
Spingibande
Empujador de bandas
Enfonce-bague

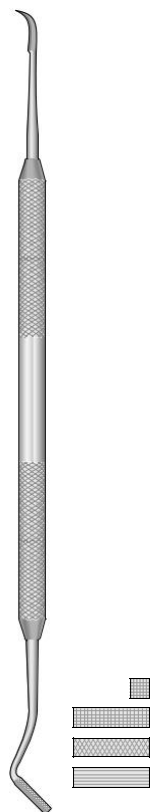
Utility Instrumente
Utility Instruments
Strumenti di utilità
Instrumentos para utilidad
Instruments pour utility

Ligaturen Instrumente
Ligating Instruments
Strumenti per legature
Instrumentos para ligaduras
Instruments pour ligatures

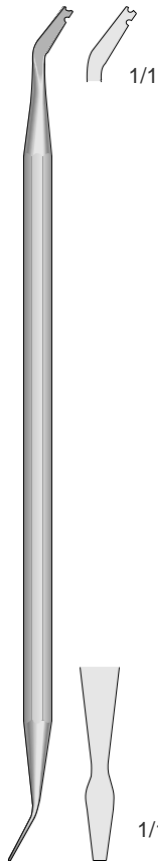
SSI-DP-100
170 mm



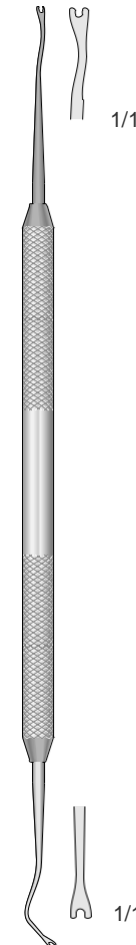
SHURE
SSI-DP-124
175 mm



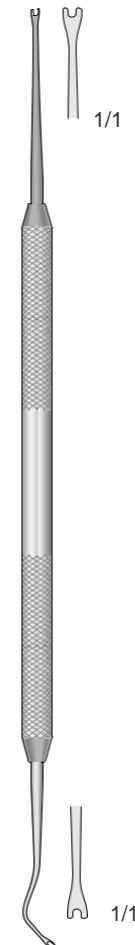
SSI-DP-54
175 mm



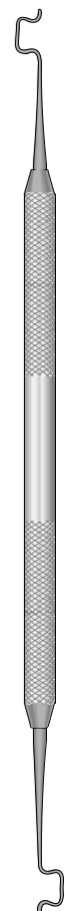
SSI-DP-125
155 mm



SSI-PF-1
170 mm



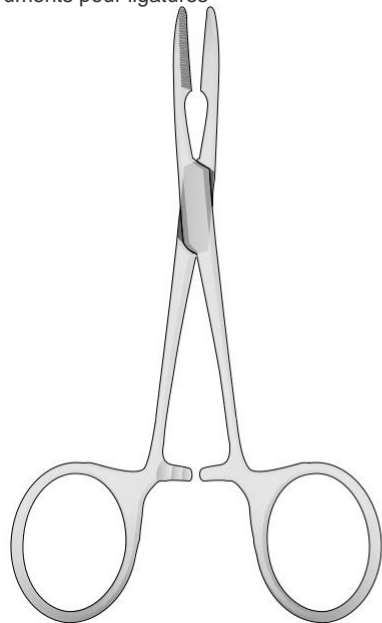
SSI-PF-2
170 mm



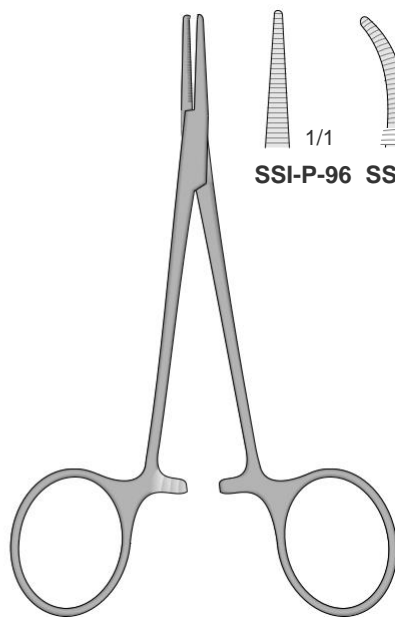
SSI-PF-3
160 mm

Email: sheffieldsurgicalinstruments@gmail.com
Web: www.sheffieldsurgicalinst.com

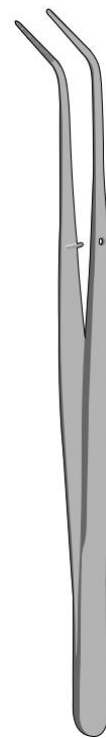
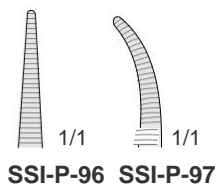
Ligature Instruments
Ligating Instruments
Strumenti per legature
Instrumentos para ligaduras
Instruments pour ligatures



PEAN-MURPHY
SSI-BF-22
130 mm



HALSTED-MOSQUITO
SSI-P-96/SSI-P-97
120 mm



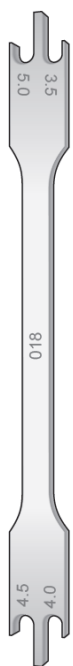
SSI-COLLEGE
150 mm



MILLER
DR-78
145 mm

Bracketset Pinzette - Forceps for positioning brackets
Pinzette per riposizionare gli attacchi diretti
(posizionamento dei bracket)
Pinza para colocar brackets - Précelle pour positionner les brackets

Bracket Gauge
Stainless Steel



SSI-DP-132
130 mm



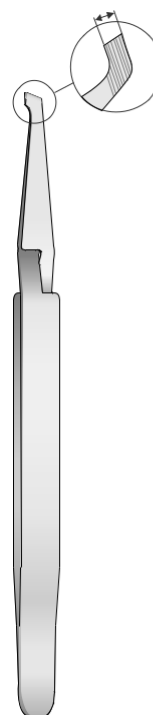
SSI-DP-133
130 mm



SSI-DP-52
130 mm



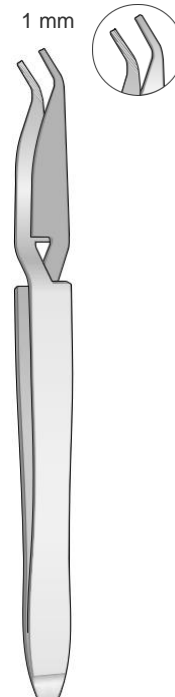
SSI-DP-126
110 mm



SSI-DP-127
125 mm



SSI-DP-128
145 mm

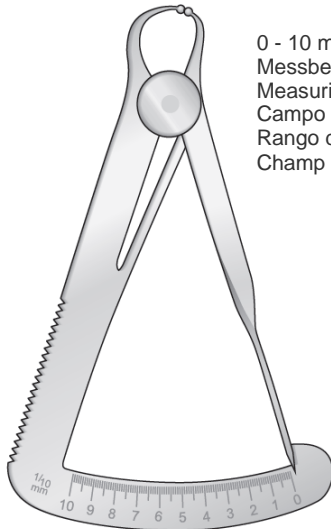


SSI-DP-129
130 mm



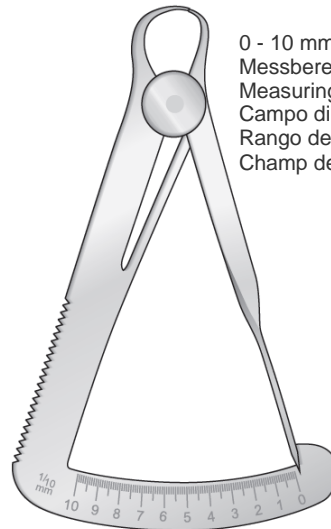
Messinstrumente
 Measuring Instruments
 Strumenti per misura
 Instrumentos de medición
 Instruments à mesurer

Dental-Schieblehre für Praxis und Labor Gauge
 Caliper for practice and laboratory Calibri dentali per
 studio e laboratorio Calibrador dental para práctica
 y el laboratorio Gauge calibreur pour practice et
 laboratoire



0 - 10 mm
 Messbereich
 Measuring range
 Campo di misura
 Rango de medición
 Champ de mesure

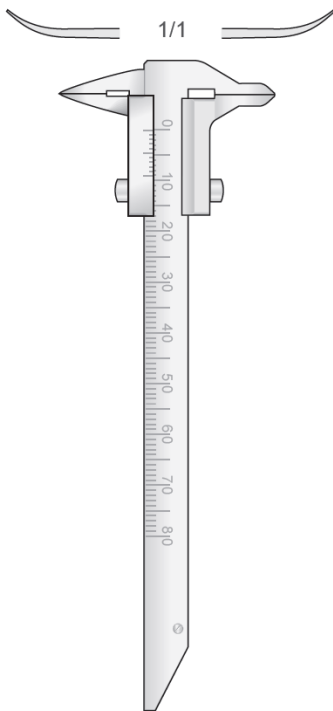
IWANSON
SSI-DP-721
 100 mm



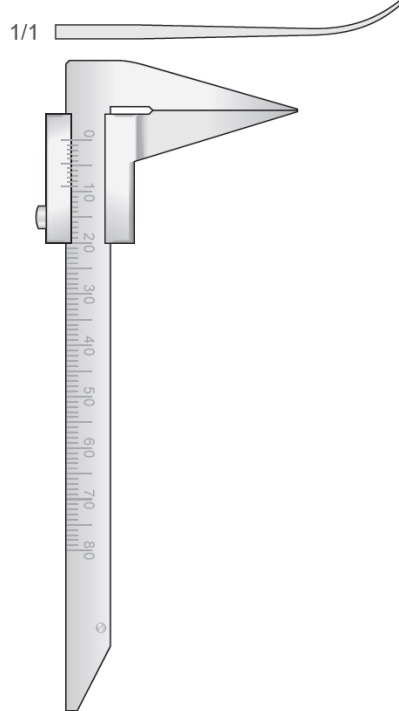
0 - 10 mm
 Messbereich
 Measuring range
 Campo di misura
 Rango de medición
 Champ de mesure

IWANSON
SSI-DP-720
 100 mm

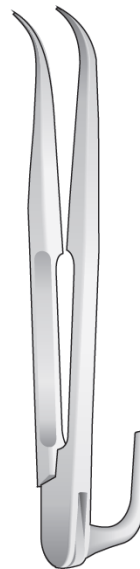
0 - 100 mm
 Messbereich
 Measuring range
 Campo di misura
 Rango de medición
 Champ de mesure



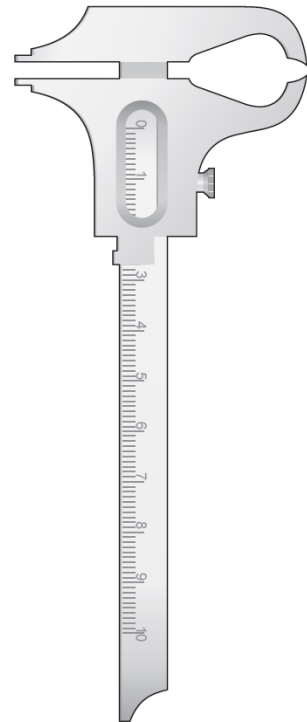
SSI-DP-723
 80 mm



SSI-DP-724
 80 mm



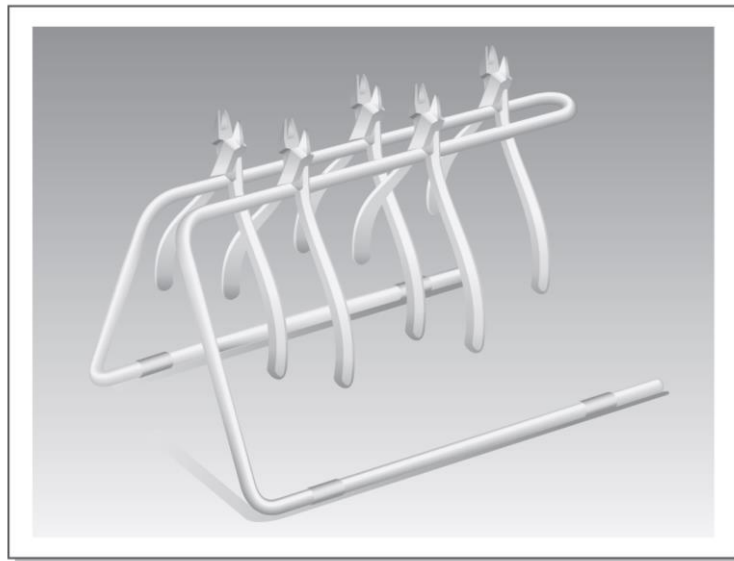
ZIELINSKY
SSI-DP-725
 110 mm



BOLEY
SSI-DP-730
 140 mm

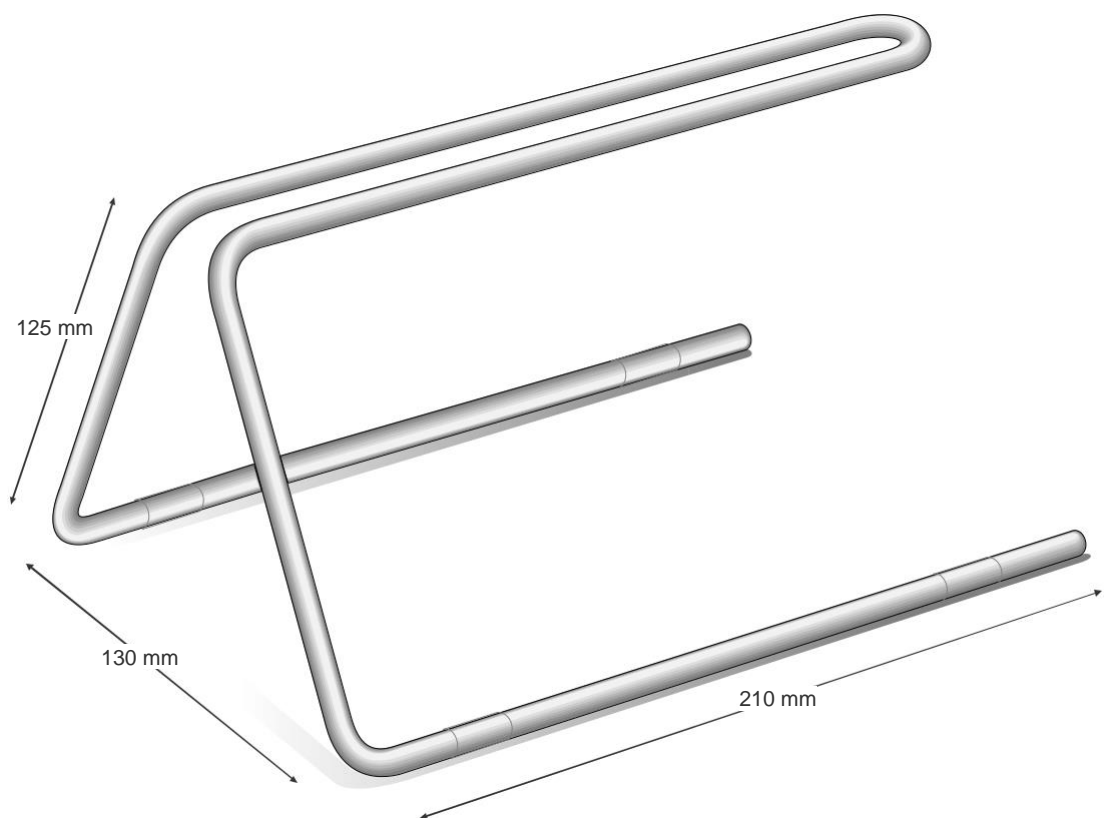
Email: sheffieldsurgicalinstruments@gmail.com
 Web: www.sheffieldsurgicalinst.com

Zubehör
Accessories
Accessori
Accesorios
Accessoires



Zangenständer
Plier Stand
Supporto per pinze
Soportes para alicates
Supports de pinces

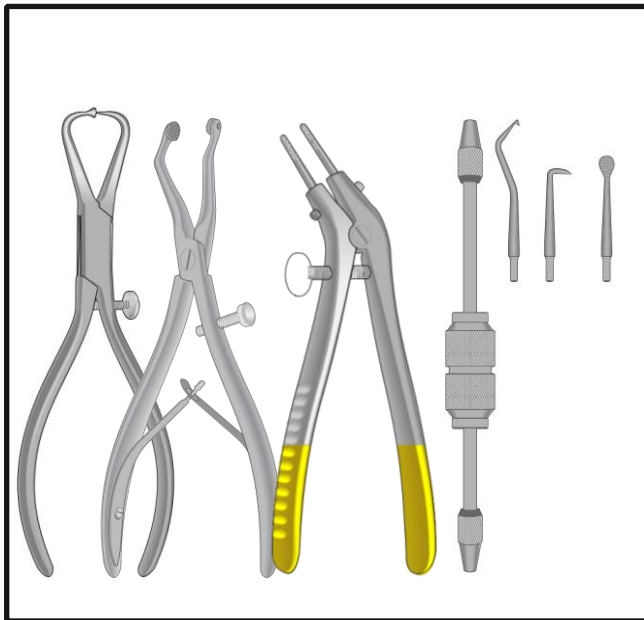
Stainless Steel
Rostfreier Stahl
Acier inoxydable
Acero inoxidable
Acciaio inossidabile



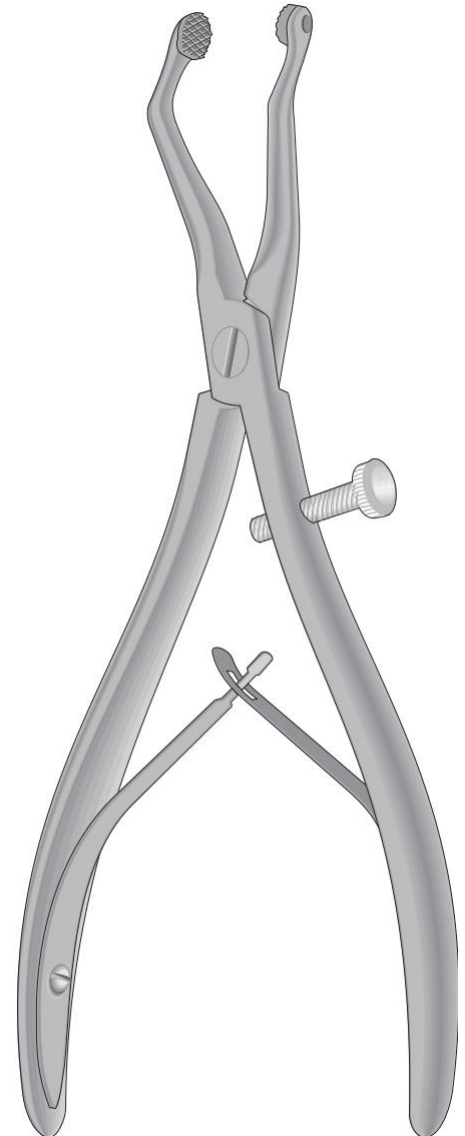
SSI-DP-140

Email: sheffieldsurgicalinstruments@gmail.com
Web: www.sheffieldsurgicalinst.com

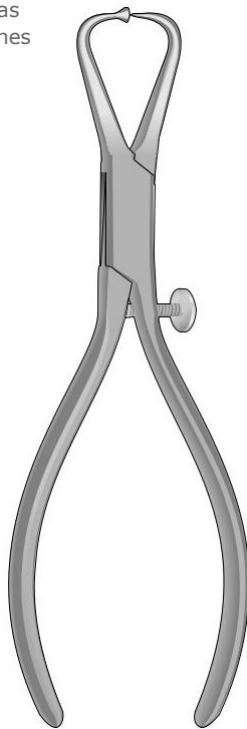
Crown Instruments
Kronenentferner
Enlève-couronne
Removedor de coronas
Leva corone



Sheffield Surgical is highly experienced Manufacturer & exporter of high quality Dental Instruments and also in the field of General Surgery, Bone Surgery an Orthopedic Instruments.

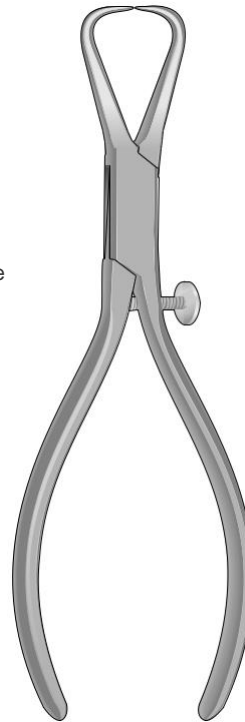


Kroneninstrumente
 Crown Instruments
 Pinze per corone
 Alicates para coronas
 Pincès pour couronnes

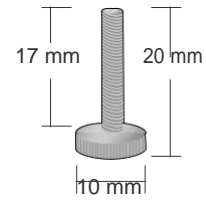


KERLING
SSI-DP-38A
 145 mm

Kupferingabnehmezange
 Copper Ring Removing Pliers
 Pinza per togliere anelli di rame
 Pinza para sacar anillos de cobre
 Pince à enlever les bagues en cuivre

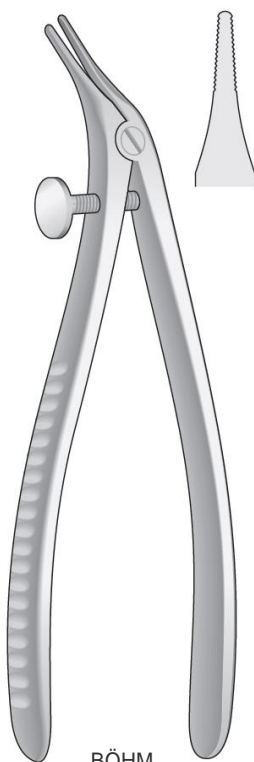


FURRER
SSI-DP-38
 145 mm

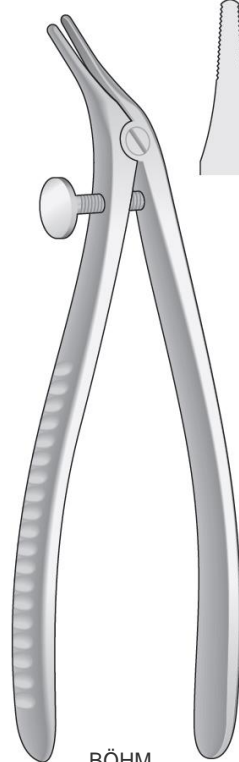
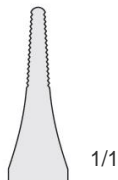


SSI-DP-38R
 Schraube
 Replacement Screw
 Vite di ricambio
 Tornillos de recambio
 Vis de rechange

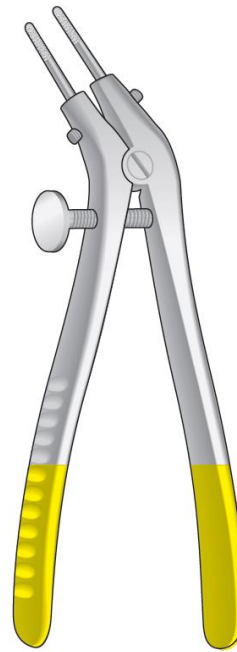
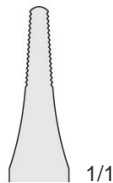
Teleskopkronenzangen - Pliers for telescope crowns
 Pinze per corone telescopiche - Alicates para coronas telescópicas
 Pincès pour couronnes telescopes



BÖHM
SSI-DP-28
 150 mm



BÖHM
SSI-DP-29
 150 mm

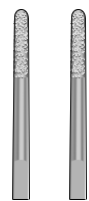


SSI-DP-24
 120 mm



SSI-DP-24C

Schlüssel
 Key
 Chiavetta
 Llave
 Clé



SSI-DP-24R

Diamantierte Einsätze, paar
 Diamond inserts, pairs
 Puntae diamantate, coppia
 Puntas diamantadas, par
 Pointes diamantées, pair



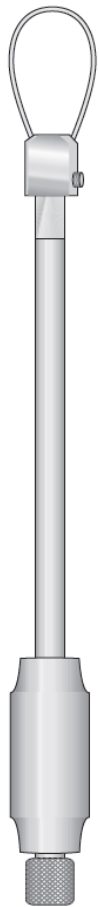
INSTRUMENTS

Kronen Instrumente Crown
Instruments Strumenti per
corone Instrumentos para
coronas Instruments pour
couronnes

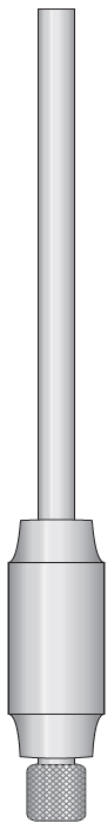
SSI-MRT/C7

BRIDGE-EXTRACTOR COMPLETE SET

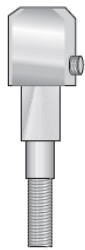
SSI-MRT-7 + SSI-C-71 + SSI-C-72
+ SSI-C-73 + SSI-C-74



SSI-MRT/C7



SSI-MRT-7



SSI-C-73



SSI-C-71
70 mm



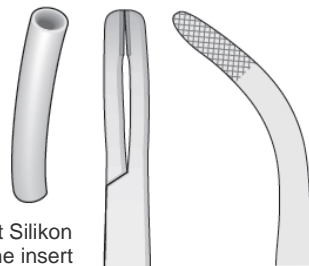
SSI-C-74



SSI-C-72
80 mm

Removing pliers
for temporary
bridges and crowns

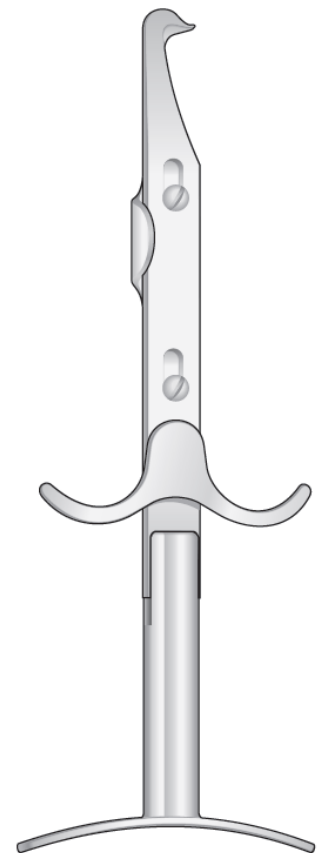
TC



Mit Silikon
With silicone insert
Con inserto in silicone
Con inserto de silicone
Avec insert en silicón

1/1

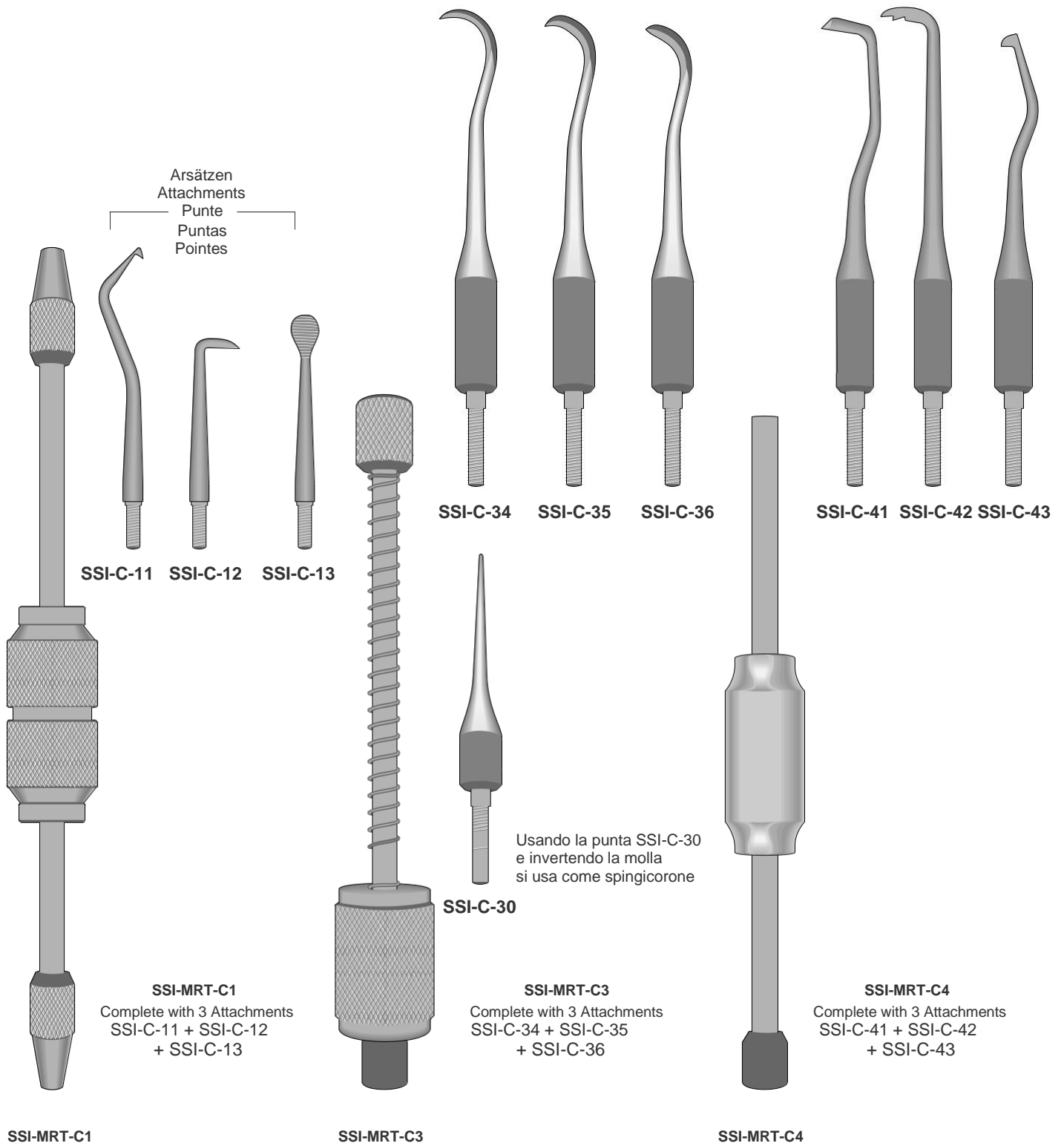
SSI-PH-60
170 mm



SSI-MRT-6
170 mm

Email: sheffieldsurgicalinstruments@gmail.com
Web: www.sheffieldsurgicalinst.com

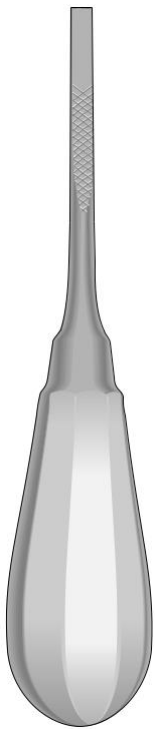
Kronentferner
 Crown Removers
 Leva corone
 Removedor de coronas
 Enlève-couronne



Email: sheffieldsurgicalinstruments@gmail.com
 Web: www.sheffieldsurgicalinst.com



Kronentferner
 Crown Removers Leva
 corone Removedor de
 coronas Enlève-
 couronne



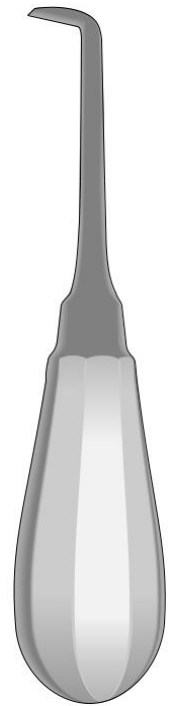
SSI-DL-C
 140 mm



**UNIVERSAL
 SSI-DL-60**
 150 mm

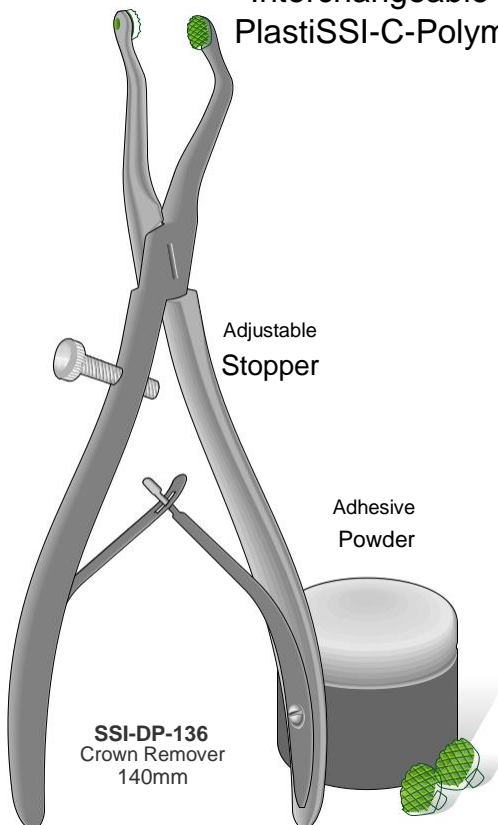


SSI-DL-V
 130 mm



SSI-DL-0
 130 mm

**Interchangeable
 PlastiSSI-C-Polymer Tips**



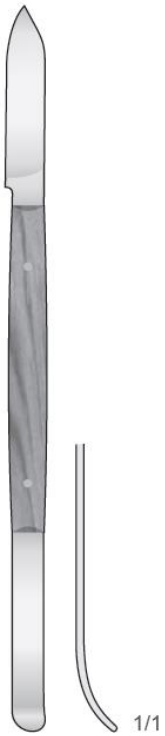
SSI-DP-136
 Crown Remover
 140mm

- SSI-DP-136
 Crown Remover Set**
 1 Crown Remover+ 10 Pairs of PlastiSSI-C-Polymer Tips + 10g Adhesive Powder
- Kronentferner Set**
 1 Kronenaufweitzange + 10 Paar Kunststoff-Polymer-Tipps + 10g Pulverkleber
- Set Enlève-Couronne**
 1 Pince à détacher les couronnes + 10 Paires de pointes de polymère plastique + 10g Adhésif en poudre
- Set Removedor de Coronas**
 1 Pinza para quitar coronas + 10 Pares de puntas de polímero plástico + 10g Polvo adhesivo
- Set Leva Corone**
 1 Pinza per corone + 10 Coppie di inserti in plastica + 10 g Polvere adesiva

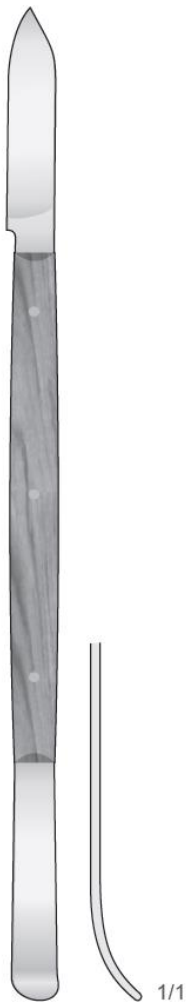
- SSI-DP-137
 Replacement Kit:** 10 Pairs of PlastiSSI-C-Polymer Tips + 10g Adhesive Powder
- Ersatz-Kit:** 10 Paar Kunststoff-Polymer-Tipps + 10g Pulverkleber
- Kit de rechange:** 10 Paires de pointes de polymère plastique + 10g Adhésif en poudre
- Kit de recambio:** 10 Pares de puntas de polímero plástico+ 10g Polvo adhesivo
- Kit di ricambio:** 10 Coppie di inserti in plastica + 10 g Polvere adesiva

Email: sheffieldsurgicalinstruments@gmail.com
 Web: www.sheffieldsurgicalinst.com

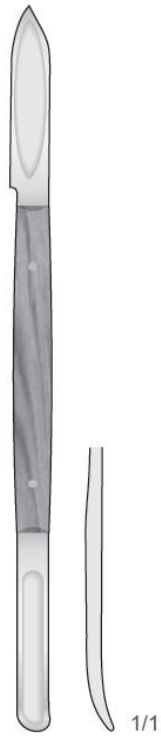
Wachsmesser
 Wax Knives
 Coltelli per cera
 Cuchillos para cera
 Couteaux à cire



FAHNENSTOCK
 SSI-CP



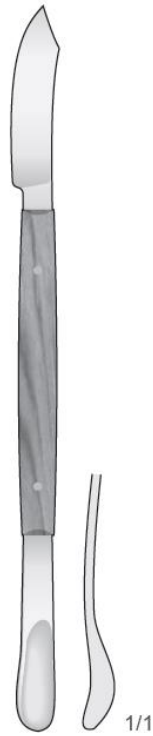
FAHNENSTOCK
 SSI-CG



LESSMANN
 SSI-CPL



LESSMANN
 SSI-CGL



SSI-CPS



SSI-CGS

Email: sheffieldsurgicalinstruments@gmail.com
 Web: www.sheffieldsurgicalinst.com



Spatel
Spatulas
Spatole
Espátulas
Spatules

Spatulas for plaster and alginate
Spatole per alginato e gesso

Flexible
Flexibel
Flexible
Flexible
Flessibile

Rigid
Fest
Rígido
Rígido
Rigido



GRITMAN
SSI-CM
175 mm



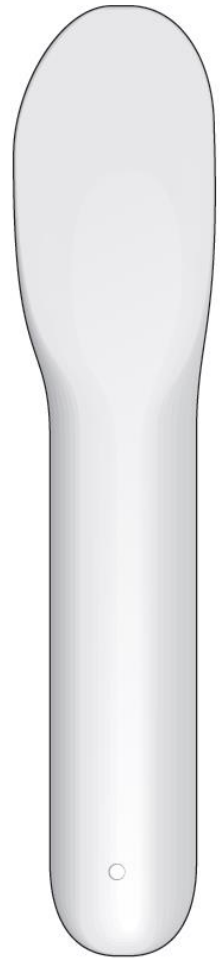
SSI-SA-1
200 mm



SSI-SA-2
200 mm



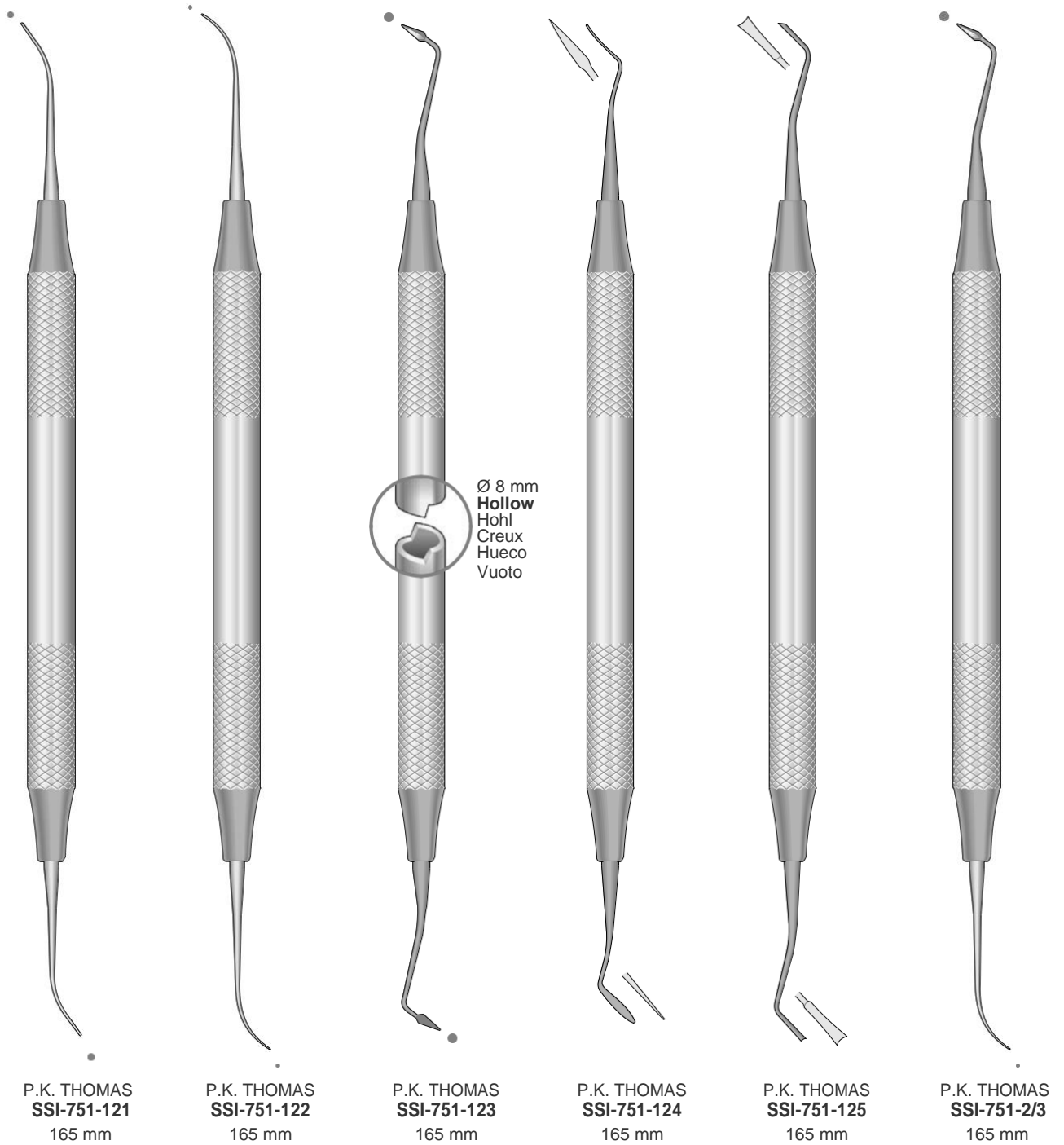
SSI-SA-3
200 mm



SSI-S18-8
185 mm

Email: sheffieldsurgicalinstruments@gmail.com
Web: www.sheffieldsurgicalinst.com

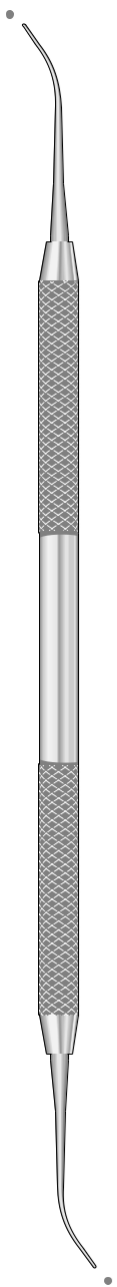
Instrumente für Laboratorium
 Instruments for laboratory
 Strumenti da laboratorio
 Instrumentos para laboratorio
 Instruments pour laboratoire



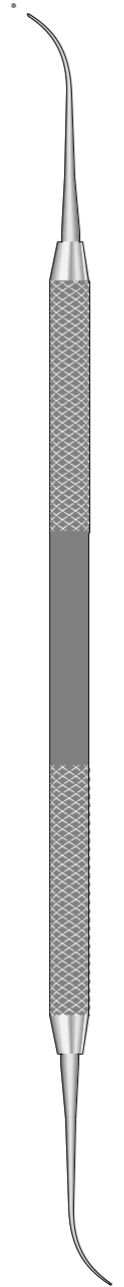
Email: sheffieldsurgicalinstruments@gmail.com
 Web: www.sheffieldsurgicalinst.com



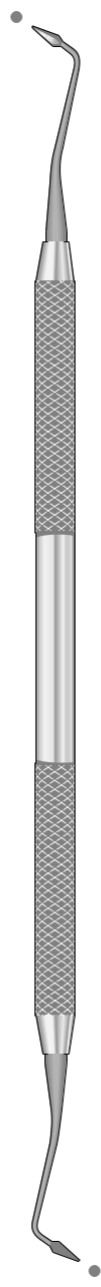
Instrumente für Laboratorium
Instruments for laboratory
Strumenti da laboratorio
Instrumentos para laboratorio
Instruments pour laboratoire



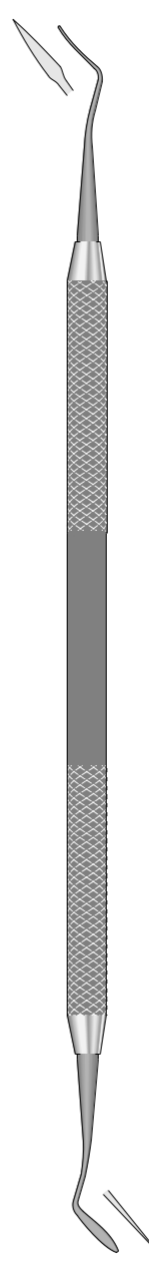
P.K. THOMAS
SSI-PT-1
165 mm



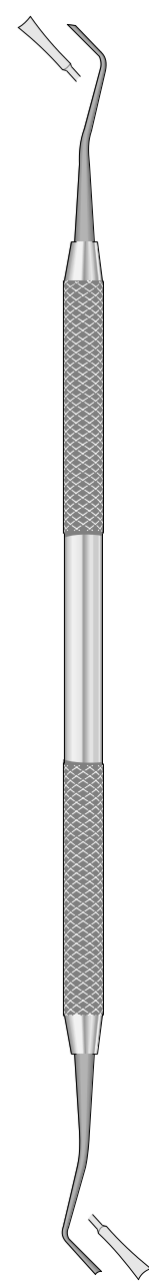
P.K. THOMAS
SSI-PT-2
165 mm



P.K. THOMAS
SSI-PT-3
165 mm



P.K. THOMAS
SSI-PT-4
165 mm

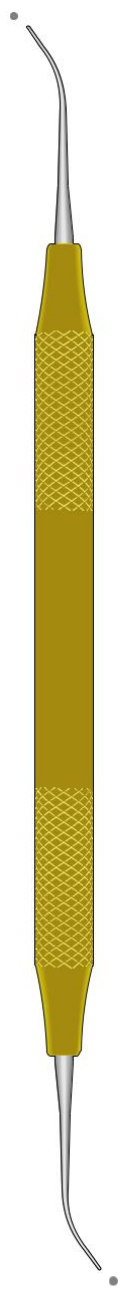


P.K. THOMAS
SSI-PT-5
165 mm

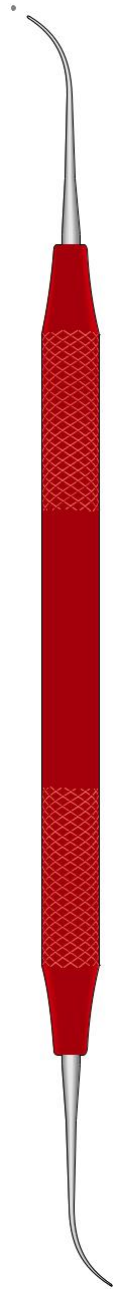
Email: sheffieldsurgicalinstruments@gmail.com
Web: www.sheffieldsurgicalinst.com

Instrumente für Laboratorium
 Instruments for laboratory
 Strumenti da laboratorio
 Instrumentos para laboratorio
 Instruments pour laboratoire

Aluminium
 Aluminium
 Aluminium
 Aluminio
 Alluminio



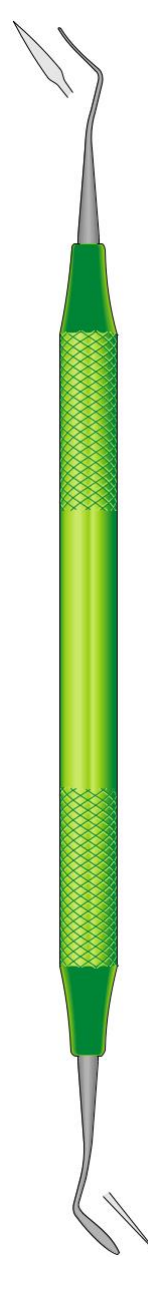
**P.K. THOMAS
 SSI-AL-PT1**
 165 mm



**P.K. THOMAS
 SSI-AL-PT2**
 165 mm



**P.K. THOMAS
 SSI-AL-PT3**
 165 mm



**P.K. THOMAS
 SSI-AL-PT4**
 165 mm



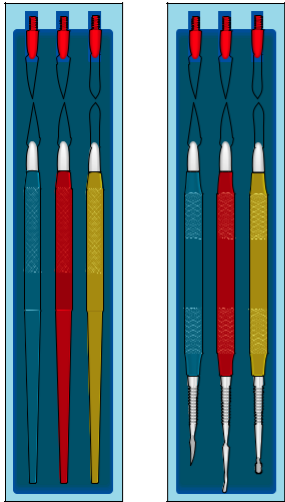
Ø 8 mm
Hollow
 Hohl
 Creux
 Hueco
 Vuoto

**P.K. THOMAS
 SSI-AL-PT5**
 165 mm

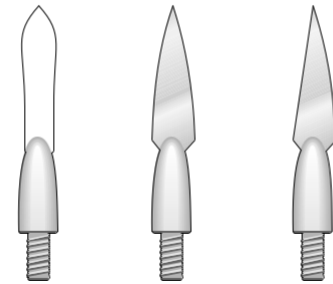
**Email: sheffieldsurgicalinstruments@gmail.com
 Web: www.sheffieldsurgicalinst.com**



Modellierinstrumente für Keramik
Ceramic Sculpturing Instruments
Strumenti per ceramica
Instrumentos para modelar la cerámica
Instruments à modeler la céramique

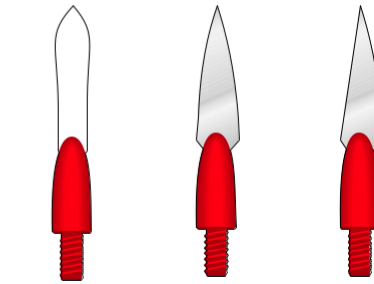


Biegsam - Flexible
Flessibili - Flexibles
Flexibles



SSI-CL-1B SSI-CL-2B SSI-CL-3B

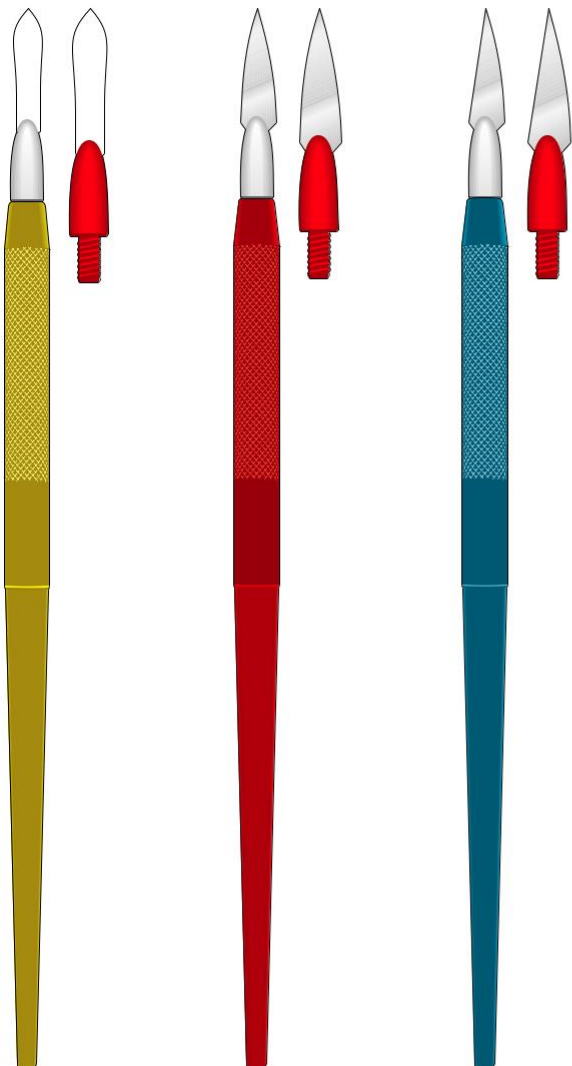
Superbiegsam - Superflexible
Superflessibili - Superflexibles
Superflexibles



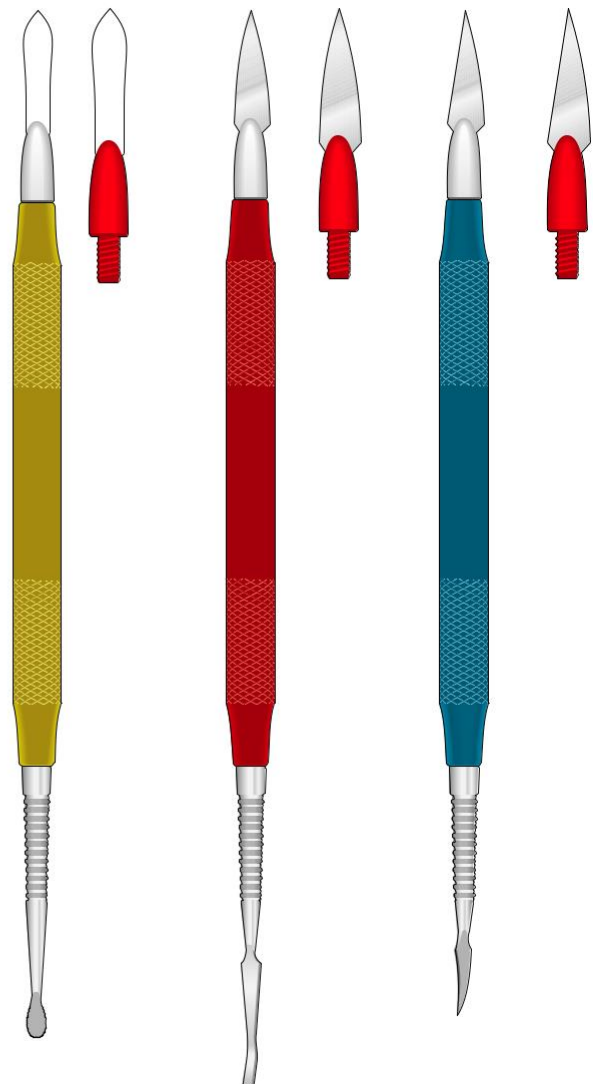
SSI-CL-1R SSI-CL-2R SSI-CL-3R

Aluminium
Aluminium
Aluminium
Aluminio
Alluminio

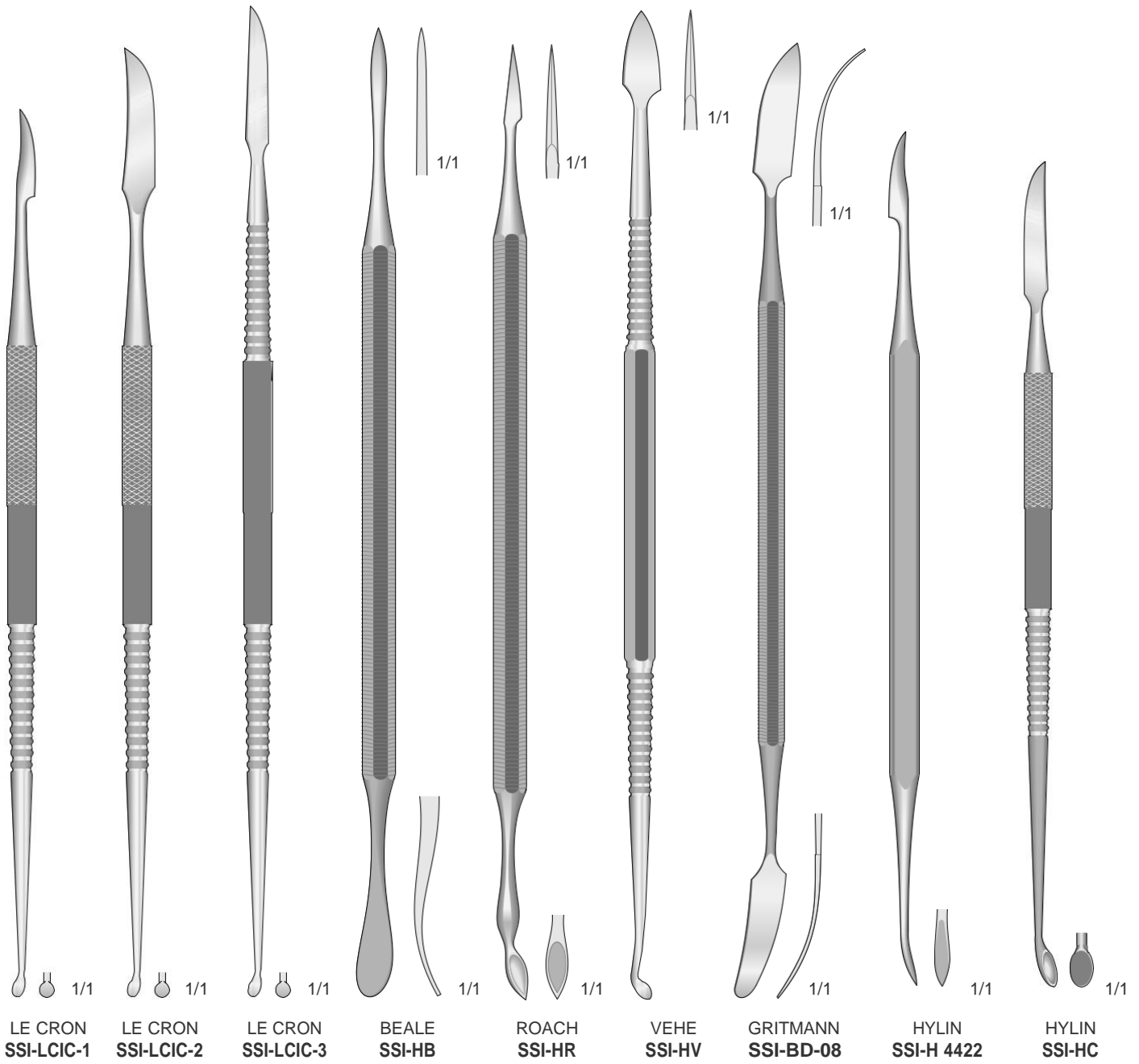
SSI-AL-SETC/1



SSI-AL-SETC/2



Email: sheffieldsurgicalinstruments@gmail.com
Web: www.sheffieldsurgicalinst.com



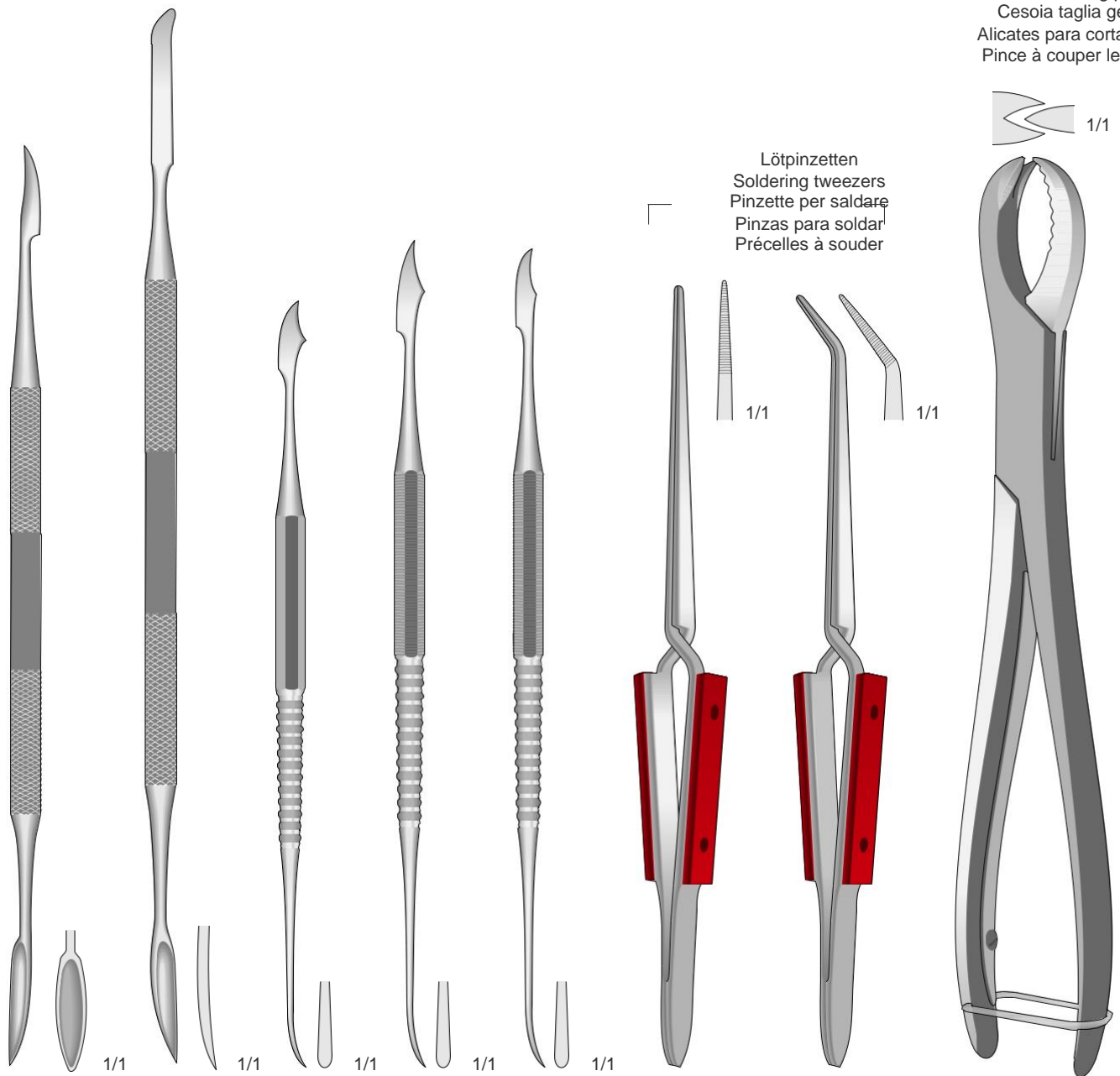
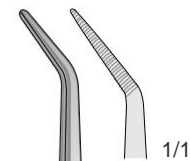
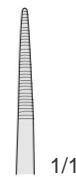


Instrumente für Laboratorium
 Instruments for laboratory
 Strumenti da laboratorio
 Instrumentos para laboratorio
 Instruments pour laboratoire

Gippschneidezange
 Plaster cutting pliers
 Cesioia taglia gesso
 Alicates para cortar yeso
 Pince à couper le piâtre



Lötpinzetten
 Soldering tweezers
 Pinzette per saldare
 Pinzas para soldar
 Précelles à souder



HYLIN
SSI-HA

1/1

HYLIN
SSI-HL

1/1

ZAHLE
SSI-Z-1

1/1

ZAHLE
SSI-Z-2

1/1

ZAHLE
SSI-Z-3

1/1

SSI-PS-1
170 mm

SSI-PS-2
165 mm

SSI-BK-30
210 mm

Email: sheffieldsurgicalinstruments@gmail.com
 Web: www.sheffieldsurgicalinst.com

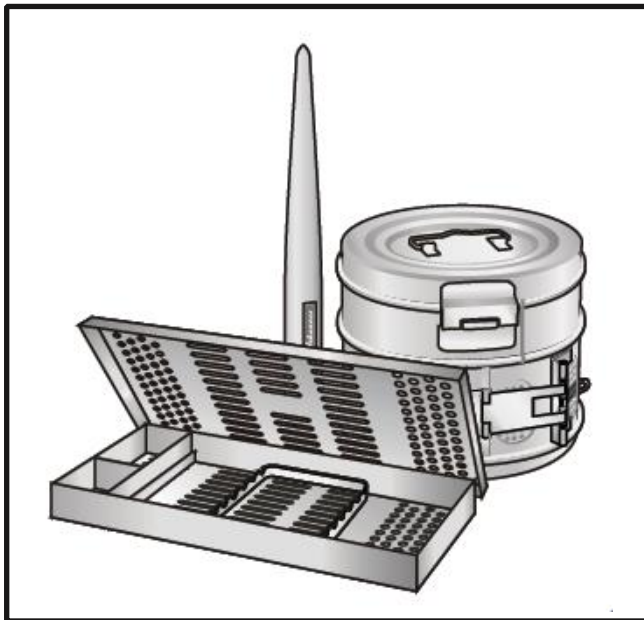
Instrument Maintenance

Instrumentenwartung

Entretien des instruments

Mantenimiento de instrumentos

Manutenzione degli strumenti



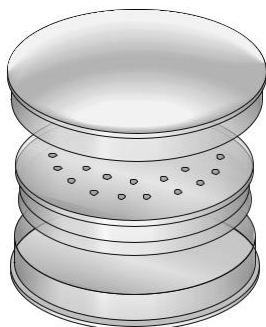
Sheffield Surgical is highly experienced Manufacturer & exporter of high quality Dental Instruments and also in the field of General Surgery, Bone Surgery an Orthopedic Instruments.



Email: sheffieldsurgicalinstruments@gmail.com
Web: www.sheffieldsurgicalinst.com

Gefäße aus Edelstahl
 Stainless Steel Receptacles
 Recipienti in acciaio inossidabile
 Recipientes de acero inoxidable
 Récipientes en acier inoxydable

Nadeldose
 Needle case
 Scatola per aghi
 Caja para agujas
 Boîte à aiguilles



SSI-BS-1
 Ø 78 mm h 15 mm

Nierenschalen
 Kidney bowls
 Bacinelle reniformi
 Riñoneras
 Bassins réniformes



SSI-BR-20 200 mm
SSI-BR-25 250 mm
SSI-BR-28 280 mm



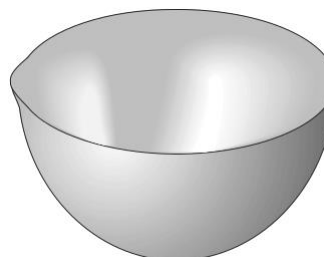
SSI-BS-32
 180 x 85 x 20 mm

Verbandstofftrommeln
 Dressing sterilizing drums
 Cestelli cilindrici
 Caja para esterilización
 Boîte à stérilisation

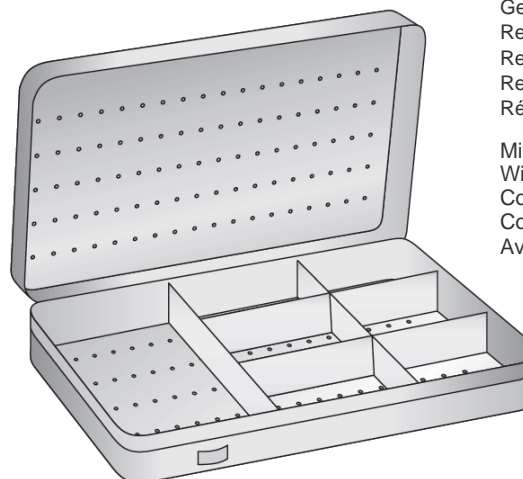


SSI-CS-12 125x125 mm
SSI-CS-15 150x150 mm
SSI-CS-19 190x145 mm

Runder Sterilbehälter mit Ausguss
 Round sterile bowl
 Capsule inox con fondo piano e becco
 Cubetas de acero inoxidable
 Cuvettes de acier inoxydable



SSI-CS-01 Ø 40 mm 15 cc
SSI-CS-02 Ø 60 mm 75 cc
SSI-CS-03 Ø 60 mm 75 cc
SSI-CS-04 Ø 100 mm 325 cc
SSI-CS-05 Ø 120 mm 500 cc



SSI-BS-27
 150 x 90 x 20 mm

Gefäße
 Receptacles
 Recipiente
 Recipientes
 Récipientes

Mit 7 box
 With 7 box
 Con 7 box
 Con 7 box
 Avec 7 box

Email: sheffieldsurgicalinstruments@gmail.com
 Web: www.sheffieldsurgicalinst.com



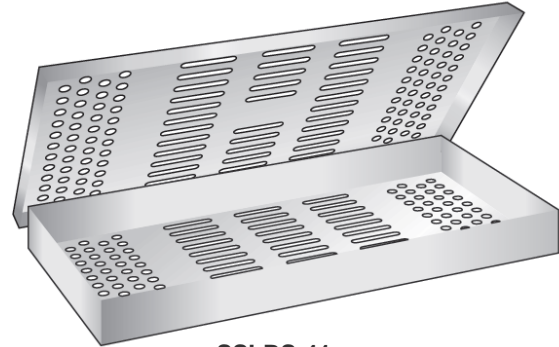
INSTRUMENTS

Steril Container
Sterilization Container
Contenitori per sterilizzazione
Contenedores para esterilización
Conteneurs pour stérilisation

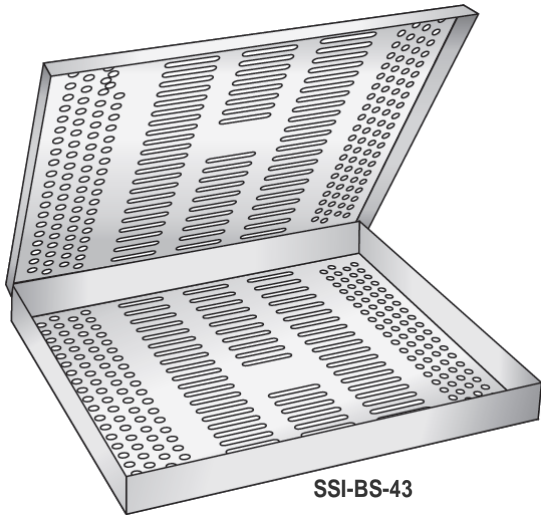
Schalen
Trays
Vassoi
Bandejas
Bassins



SSI-VS-20 210 x 110 x 25 mm
SSI-VS-26 250 x 180 x 30 mm
SSI-VS-30 300 x 220 x 30 mm

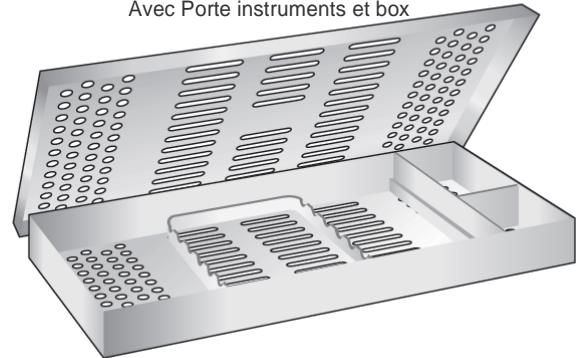


SSI-BS-41
275 x 130 x 25 mm



SSI-BS-43
285 x 190 x 25 mm

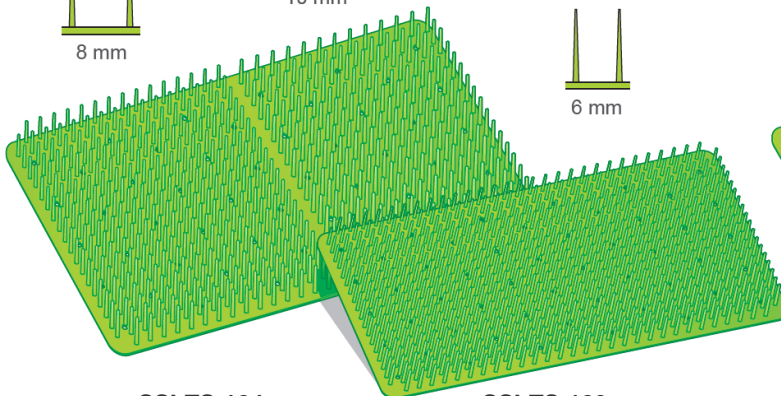
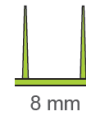
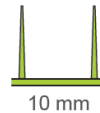
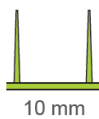
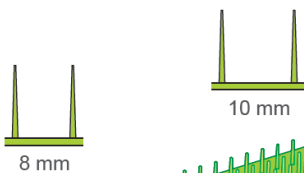
Mit Instrumentehalter und box
With Insert frames and box
Con griglia e scomparti
Con porta instrumentos y box
Avec Porte instruments et box



SSI-BS-40 275x130x25mm
SSI-BS-42 285x190x25mm

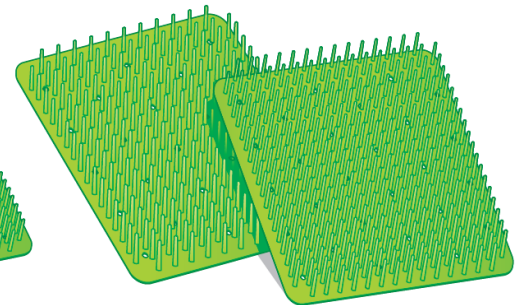
Silicon Mat
Silikon Noppenmatten
Tappeti di silicone
Tapiz de silicona
Tapis en silicone

Autoklav
Autoclavable
Autoclavabile
Autoclave
Autoclave



SSI-TS-104
270 x 180 mm

SSI-TS-103
260 x 120 mm



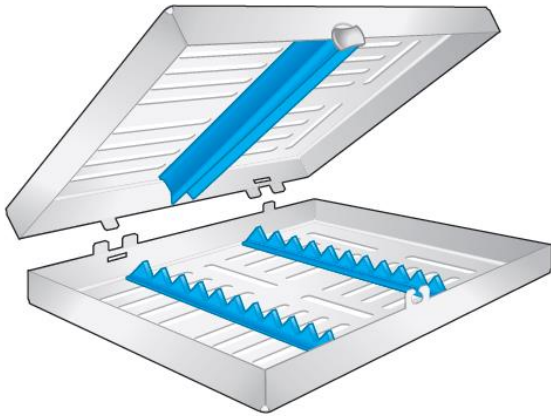
SSI-TS-102
135 x 180 mm

SSI-TS-101
135 x 180 mm

Email: sheffieldsurgicalinstruments@gmail.com
Web: www.sheffieldsurgicalinst.com

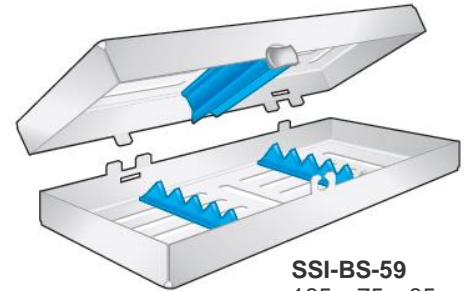
Steril Container
 Sterilization Container
 Contenitori per sterilizzazione
 Contenedores para esterilización
 Conteneurs pour stérilisation

Rostfreier Stahl Sterilcontainer mit Silikoneinrichtung
 Stainless Steel Sterilization Containers with silicone racks
 Contenitori per sterilizzazione in acciaio inossidabile con griglia in silicone
 Contenedores para esterilización en acero inoxidable con soportes en silicona
 Containers pour stérilisation en acier inoxydable avec des supports de silicone



SSI-BS-60
 185 x 135 x 35 mm
 For 10 Instruments

SSI-BS-61
 290 x 185 x 35 mm
 For 20 Instruments



SSI-BS-59
 185 x 75 x 35 mm
 For 5 Instruments

CT-555
CT-560
CT-565



Sterilcontainer,
 mit Deckel- und Bodenperforation,
 passend in gängige Praxisautoclaven
Containers for sterilization,
 with perforation in lid and bottom,
 suitable for common practice autoclaves
Contenitori dentali,
 con coperchio e fondo perforato,
 adatti a tutte le autoclavi comuni
Contenedores dentales,
 con tapa y fondo perforados,
 aptos para autoclaves habituales
Containers stérile,
 avec perforation du couvercle et du fond,
 convenant aux autoclaves courants

CT-651
CT-652
CT-653



Silikoneinrichtung für Tray Silicone
 Racks for Tray Griglia in Silicone
 per Tray Equipo de silicona para
 Tray Aménagement en silicone
 pour Tray



CT-555
 300 x 140 x 40 mm
CT-651
 310 x 190 x 40 mm

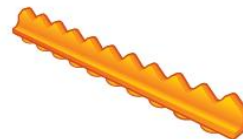
CT-560
 300 x 140 x 70 mm
CT-652
 310 x 190 x 65 mm

CT-565
 300 x 140 x 100 mm
CT-653
 310 x 190 x 130 mm

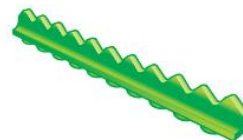
Alu
 Aluminium
 Alluminio
 Aluminio
 Aluminium



TRANSLUCENT YELLOW
SSI-SIL-01
 130 mm



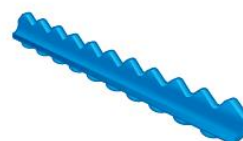
ORANGE
SSI-SIL-02
 130 mm



TRANSLUCENT GREEN
SSI-SIL-03
 130 mm



RUST RED
SSI-SIL-04
 130 mm

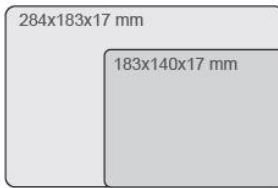


BLUE
SSI-SIL-05
 130 mm

Email: sheffieldsurgicalinstruments@gmail.com
 Web: www.sheffieldsurgicalinst.com

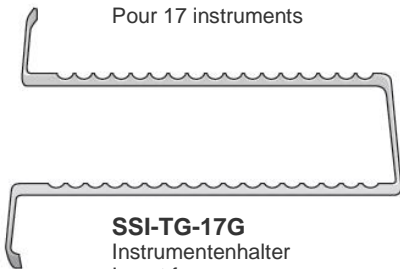


Aluminium-Tray
Aluminium Trays
Tray in alluminio
Bandejas de aluminio
Boîtes en aluminium



Farbcodiert-Tray-Unterteile für 17 instrumente
Color-Coded bases for 17 instruments
Vassoi colorati per 17 strumenti
Bandejas en colores para 17 instrumentos
Plateaux colorés pour 17 instruments

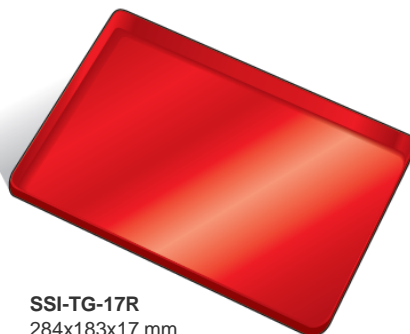
Für 17 instrumente
For 17 instruments
Per 17 strumenti
Para 17 instrumentos
Pour 17 instruments



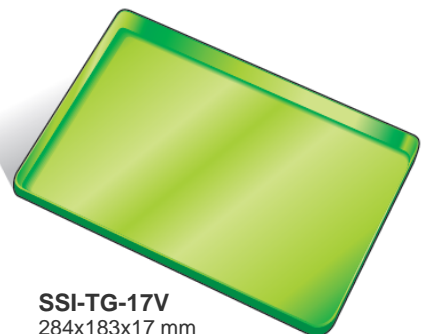
SSI-TG-17G
Instrumentenhalter
Insert frames
Griglia Portastrumenti
Porta instrumentos
Porte instruments



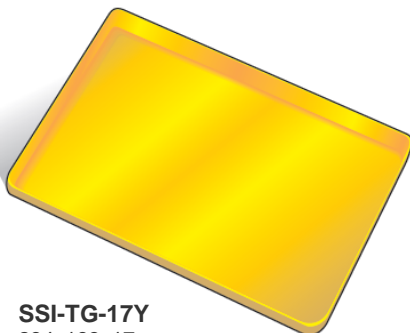
SSI-TG-17A
284x183x17 mm
Unterteile allein
Only base
Vassoio solo
Bandeja suelta
Plateau seul



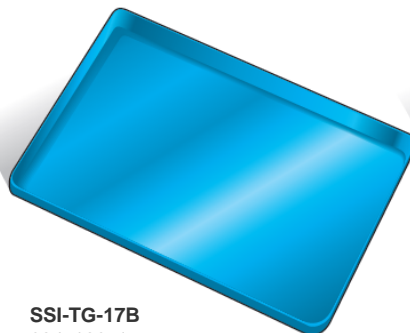
SSI-TG-17R
284x183x17 mm
Unterteile allein
Only base
Vassoio solo
Bandeja suelta
Plateau seul



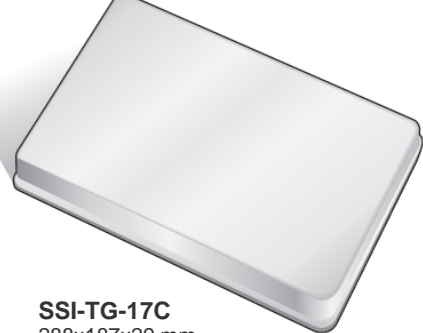
SSI-TG-17V
284x183x17 mm
Unterteile allein
Only base
Vassoio solo
Bandeja suelta
Plateau seul



SSI-TG-17Y
284x183x17 mm
Unterteile allein
Only base
Vassoio solo
Bandeja suelta



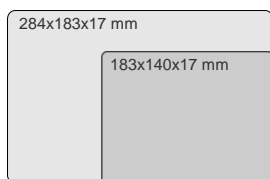
SSI-TG-17B
284x183x17 mm
Unterteile allein
Only base
Vassoio solo
Bandeja suelta



SSI-TG-17C
288x187x29 mm
Tray-Deckel, grau
Lid - Grey only
Coperchio - Solo argento
Tapa en color gris
Couvercle - seulement en gris

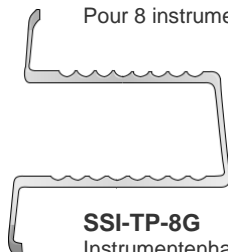
Email: sheffieldsurgicalinstruments@gmail.com
Web: www.sheffieldsurgicalinst.com

Aluminium MIDI Tray
 Aluminium MIDI Trays
 Tray in alluminium, misura MIDI
 Bandejas de aluminio, tamaño MIDI
 Boîtes en aluminium, format MIDI

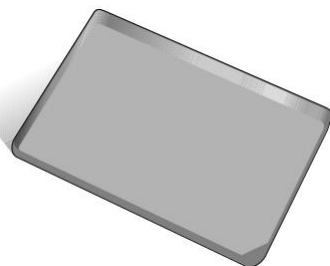


Farbcodiert-Tray-Unterteile für 8 instrumente
 Color-Coded bases for 8 instruments
 Vassoi colorati per 8 strumenti
 Bandejas en colores para 8 instrumentos
 Plateaux colorés pour 8 instruments

Für 8 instrumente
 For 8 instruments
 Per 8 strumenti
 Para 8 instrumentos
 Pour 8 instruments



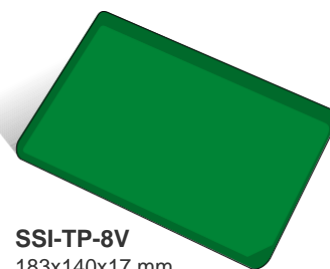
SSI-TP-8G
 Instrumentenhalter
 Insert frames
 Griglia Portastrumenti
 Porta instrumentos
 Porte instruments



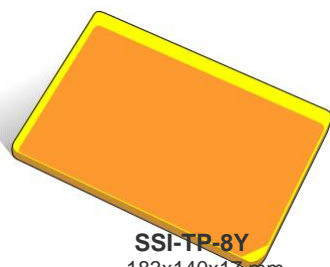
SSI-TP-8A
 183x140x17 mm
 Unterteile allein
 Only base
 Vassoio solo
 Bandeja suelta
 Plateau seul



SSI-TP-8R
 183x140x17 mm
 Unterteile allein
 Only base
 Vassoio solo
 Bandeja suelta
 Plateau seul



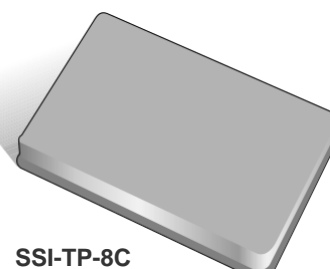
SSI-TP-8V
 183x140x17 mm
 Unterteile allein
 Only base
 Vassoio solo
 Bandeja suelta
 Plateau seul



SSI-TP-8Y
 183x140x17 mm
 Unterteile allein
 Only base
 Vassoio solo
 Bandeja suelta



SSI-TP-8B
 183x140x17 mm
 Unterteile allein
 Only base
 Vassoio solo
 Bandeja suelta

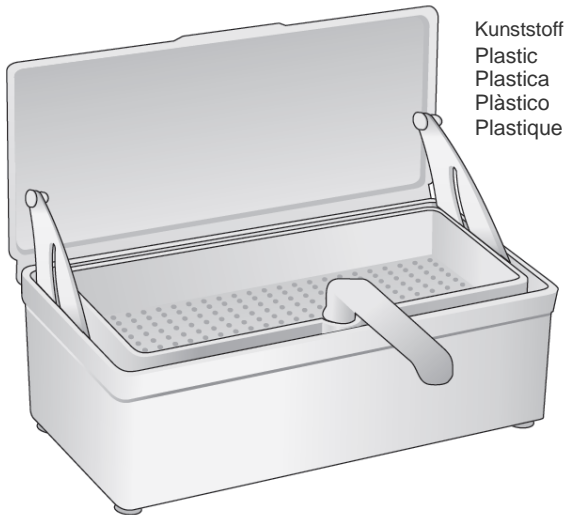


SSI-TP-8C
 187x145x25 mm
 Tray-Deckel, grau
 Lid - Grey only
 Coperchio - Solo argento
 Tapa en color gris
 Couvercle - seulement en gris

Email: sheffieldsurgicalinstruments@gmail.com
 Web: www.sheffieldsurgicalinst.com

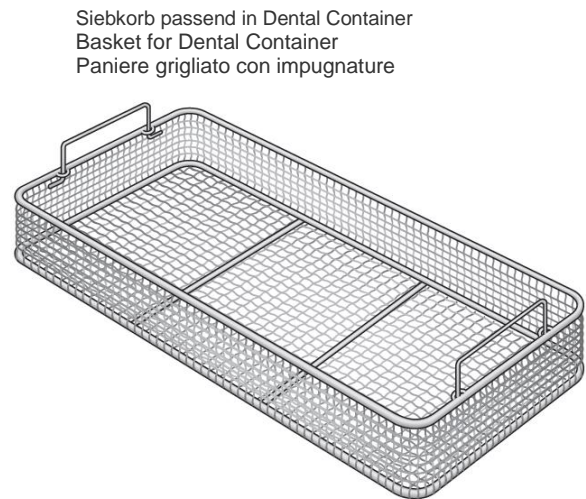


Steril Container
Sterilization Container
Contenitori per sterilizzazione
Contenedores para esterilización
Conteneurs pour stérilisation



Kunststoff
Plastic
Plastica
Plástico
Plastique

SSI-BS-100
255 x 105 x 85 mm

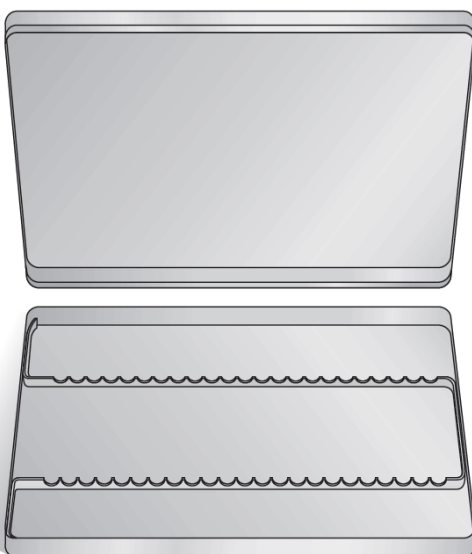


Siebkorb passend in Dental Container
Basket for Dental Container
Paniere grigliato con impugnature

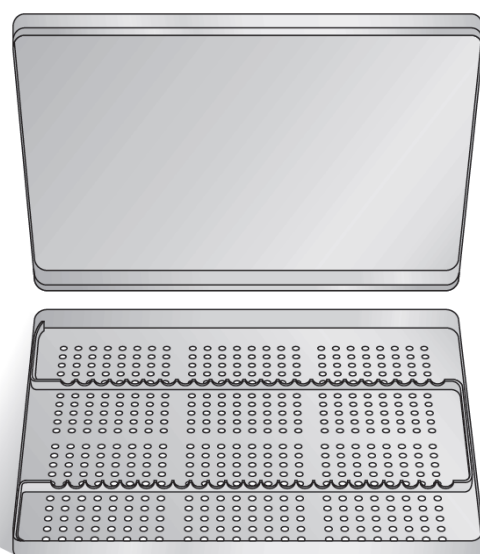
SSI-SSI-CT-650
265 x 120 x 45 mm

Rostfrei - Stainless steel - Inox - Inoxidable - Inoxydable

Norm-tray complet mit tray-unterteile, deckel und instrumentenhalter für 23 instrumente
Instrument tray complete with base, lid and insert frame for 23 instruments
Portastrumenti completo di vassoio, coperchio e griglia per 23 strumenti
Bandeja completa de tapa y porta instrumentos para 23 instrumentos
Boite complete avec plateau et couvercle pour 23 instruments



TRAY INOX
SSI-T-I
284 x 183 x 17 mm

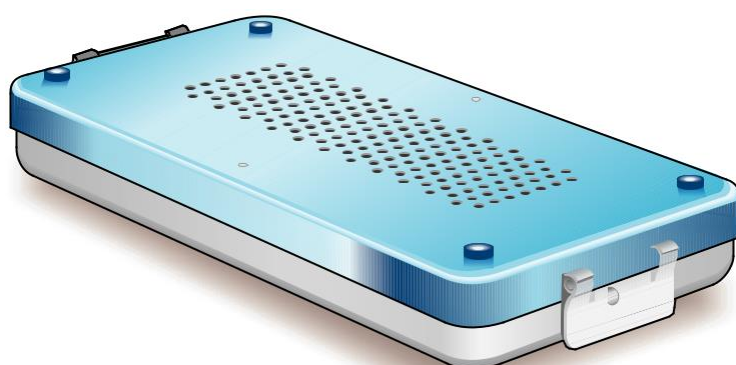


TRAY INOX
SSI-T-IF
284 x 183 x 17 mm






Email: sheffieldsurgicalinstruments@gmail.com
Web: www.sheffieldsurgicalinst.com

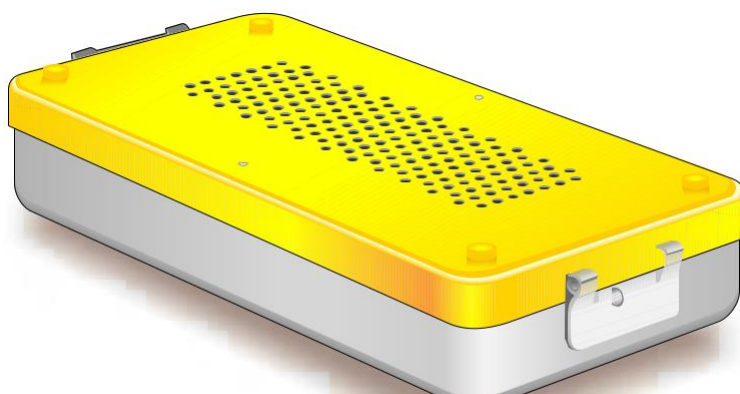
Steril Container
 Sterilization Container
 Contenitori per sterilizzazione
 Contenedores para esterilización
 Conteneurs pour stérilisation

Stainless Steel - Aluminium
 Rostfrei - Aluminium
 Acier inoxydable - Aluminium
 Acero inoxidable - Aluminio
 Acciaio inossidabile - Alluminio








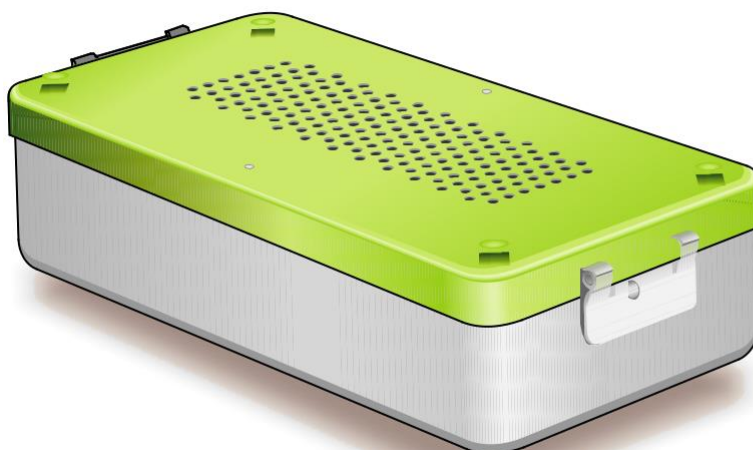
Small
 outside: 300 x 140 x 40 mm
 inside: 280 x 130 x 27 mm

-  SSI-CT-555N
-  SSI-CT-556N
-  SSI-CT-557N
-  SSI-CT-558N
-  SSI-CT-559N








Medium
 outside: 300 x 140 x 70 mm
 inside: 280 x 130 x 55 mm

-  SSI-CT-560N
-  SSI-CT-561N
-  SSI-CT-562N
-  SSI-CT-563N
-  SSI-CT-564N



Large
 outside: 300 x 140 x 100 mm
 inside: 280 x 130 x 84 mm

-  SSI-CT-565N
-  SSI-CT-566N
-  SSI-CT-567N
-  SSI-CT-568N
-  SSI-CT-569N

Email: sheffieldsurgicalinstruments@gmail.com
 Web: www.sheffieldsurgicalinst.com

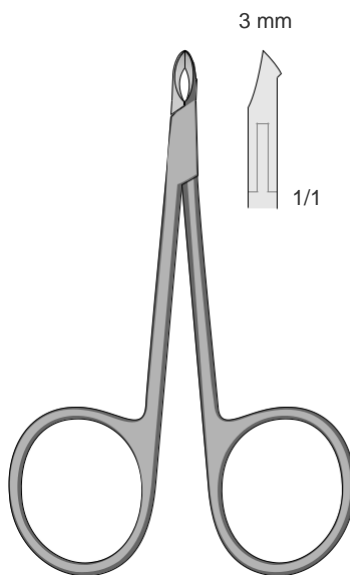


Vorbereitung - Nagel scheren
Preparation - Nail scissors
Preparazione - Forbici per unghie
Preparación - Tijeras para uñas
Préparation - Ciseaux à ongles

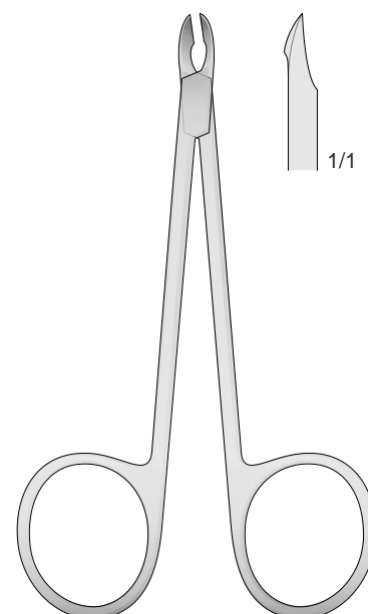
Handwaschbürste
Nail brushes
Spazzola per unghie
Cepillo para uñas
Brosse à ongles



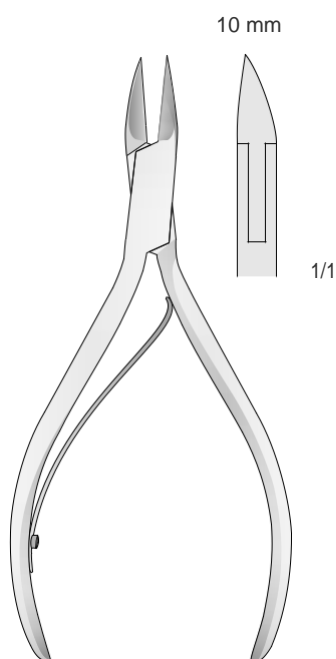
SSI-GF-200
4 x 11 cm
Autoclavable



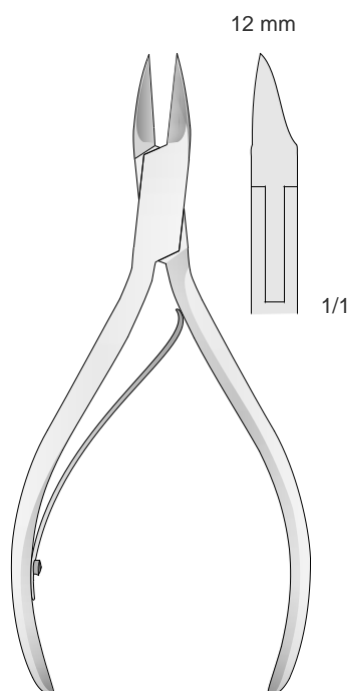
SSI-GS-40
85 mm



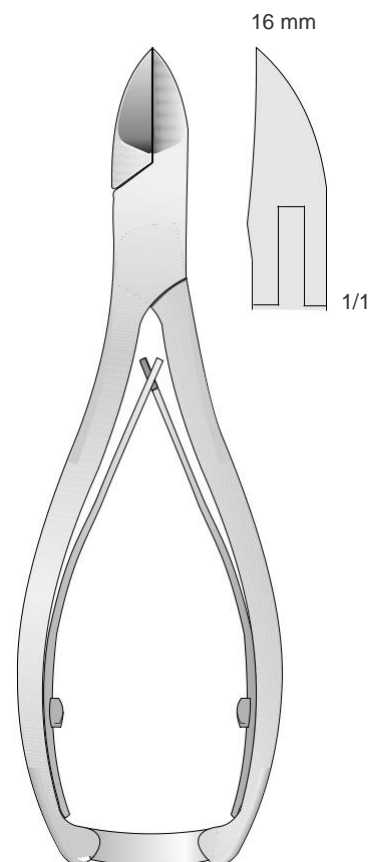
SSI-GS-52
100 mm



SSI-GS-42
100 mm



SSI-GS-44
110 mm



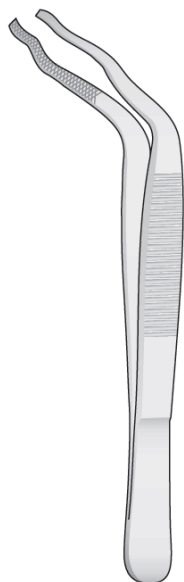
SSI-GS-48
140 mm

Email: sheffieldsurgicalinstruments@gmail.com
Web: www.sheffieldsurgicalinst.com

Vorbereitung - Nagel scheren
 Preparation - Nail scissors
 Preparazione - Forbici per unghie
 Preparación - Tijeras para uñas
 Préparation - Ciseaux à ongles



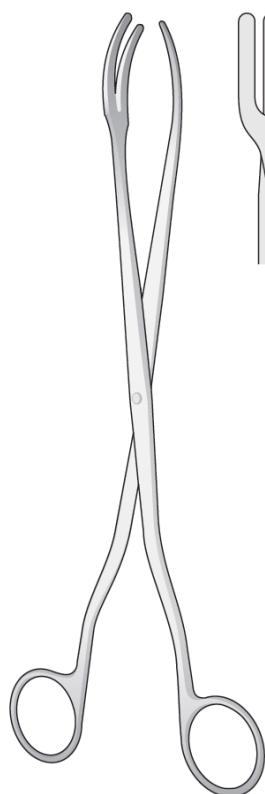
SSI-GS-02
145 mm



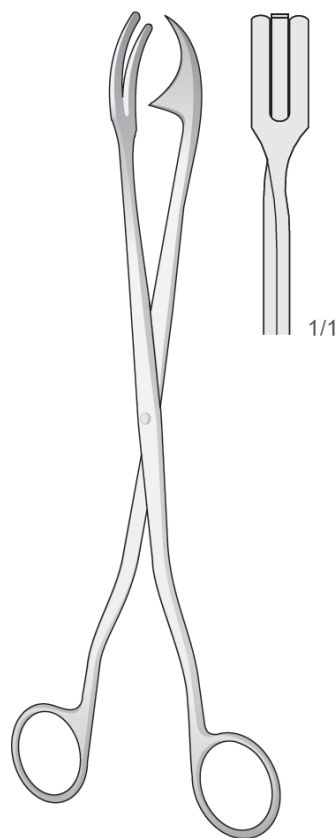
DAVIS
SSI-GS-03
160 mm



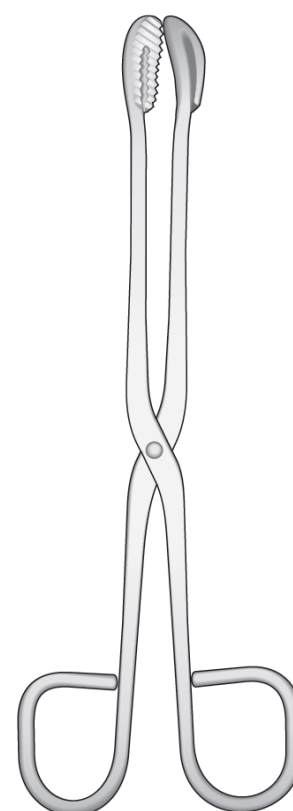
DAVIS
SSI-GS-04
200 mm



SSI-GS-10
200 mm



ROGGE
SSI-GS-06
230 mm



SSI-GS-13
200 mm

Email: sheffieldsurgicalinstruments@gmail.com
 Web: www.sheffieldsurgicalinst.com



SHEFFIELD SURGICAL BUILDING
Wazirabad Road, Ugoki, Sialkot-51310 Pakistan.

WhatsApp # +92-333-1400682
Email: sheffieldsurgicalinstruments@gmail.com
Email: info@sheffieldsurgicalinst.com
Web: www.sheffieldsurgicalinst.com

