

Surgical Instruments Catalogue  
Chirurgische Instrumente Katalog  
Instruments chirurgicaux catalogue

## Cardio Vascular Instruments Catalogue



Manufacturer & Exporters of Surgical Instruments



**SHEFFIELD  
SURGICAL  
INSTRUMENTS**

Quality

Instruments

Since 1992





SHEFFIELD SURGICAL BUILDING  
Wazirabad Road, Ugoki, Sialkot-51310 Pakistan.

WhatsApp # +92-333-0322424  
Email: sheffieldsurgicalinstruments@gmail.com  
Email: sales@sheffieldsurgicalinst.com  
Web: www.sheffieldsurgicalinst.com



Email: [sheffieldsurgicalinstruments@gmail.com](mailto:sheffieldsurgicalinstruments@gmail.com)  
Web: [www.sheffieldsurgicalinst.com](http://www.sheffieldsurgicalinst.com)

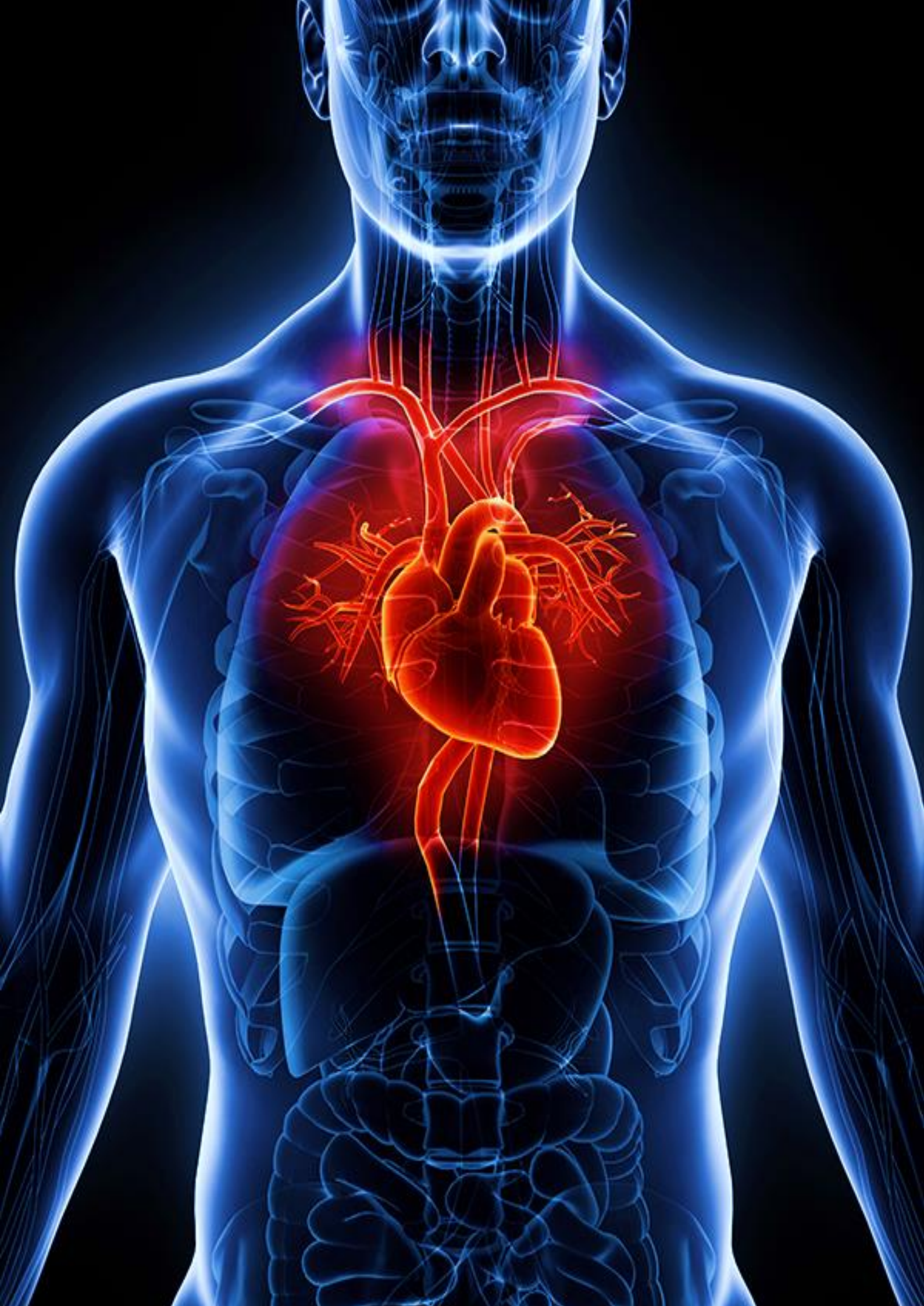

# MICRO NEEDLE HOLDERS

## Castroviejo Micro Needle Holder

- Flat Handled
- Tungsten Carbide Jaws
- Straight 1.2mm Jaws



With Lock	Serrated Jaws	Smooth Jaws	Without Lock	Serrated Jaws	Smooth Jaws
13cm/5"	SSI-1003-13	SSI-1003-13S	13cm/5"	SSI-1103-13	SSI-1103-13S
18cm/7"	SSI-1003-18	SSI-1003-18S	18cm/7"	SSI-1103-18	SSI-1103-18S
20cm/8"	SSI-1003-20	SSI-1003-20S	20cm/8"	SSI-1103-20	SSI-1103-20S
21cm/8 1/4"	SSI-1003-21	SSI-1003-21S	21cm/8 1/4"	SSI-1103-21	SSI-1103-21S

## Castroviejo Micro Needle Holder

- Flat Handled
- Diamond Dusted Jaws
- Straight 1.2mm Jaws



With Lock		Without Lock	
14cm/5 1/2"	SSI-1001-14	14cm/5 1/2"	SSI-1101-14
18cm/7"	SSI-1001-18	18cm/7"	SSI-1101-18
21cm/8 1/4"	SSI-1001-21	21cm/8 1/4"	SSI-1101-21

## **Titanium** Castroviejo Micro Needle Holder

- Flat Handled
- Diamond Dusted Jaws
- Straight 1.2mm Jaws



With Lock		Without Lock	
15cm/6"	SSI-1001-15T	15cm/6"	SSI-1101-15T
18cm/7"	SSI-1001-18T	18cm/7"	SSI-1101-18T
21cm/8 1/4"	SSI-1001-21T	21cm/8 1/4"	SSI-1101-21T
24cm/9 1/2"	SSI-1001-24T	24cm/9 1/2"	SSI-1101-24T

# MICRO NEEDLE HOLDERS

## Reill Micro Needle Holder

- Round Bodied
- Diamond Dusted Jaws
- Delicate 1mm Jaws



With Lock	Straight	Curved	Without Lock	Straight	Curved
14.5cm/5 <sup>3</sup> / <sub>4</sub> "	SSI-1005-14	SSI-1006-14	14.5cm/5 <sup>3</sup> / <sub>4</sub> "	SSI-1105-14	SSI-1106-14

## Jacobson Micro Needle Holder

- Round Bodied
- Diamond Dusted Jaws
- Straight Delicate 1mm Jaws



With Lock		Without Lock	
18cm/7"	SSI-1005-18	18cm/7"	SSI-1105-18
21cm/8 <sup>1</sup> / <sub>4</sub> "	SSI-1005-21	21cm/8 <sup>1</sup> / <sub>4</sub> "	SSI-1105-21
23cm/9"	SSI-1005-23	23cm/9"	SSI-1105-23

## **Titanium** Jacobson Micro Needle Holder

- Round Bodied
- Diamond Dusted Jaws
- Straight



With Lock	Standard 1.2mm Jaws	Delicate 1mm Jaws	Without Lock	Standard 1.2mm Jaws	Delicate 1mm Jaws
15cm/6"	SSI-1005-15T	SSI-1005-15FT	15cm/6"	SSI-1105-15T	SSI-1105-15FT
18cm/7"	SSI-1005-18T	SSI-1005-18FT	18cm/7"	SSI-1105-18T	SSI-1105-18FT
21cm/8 <sup>1</sup> / <sub>4</sub> "	SSI-1005-21T	SSI-1005-21FT	21cm/8 <sup>1</sup> / <sub>4</sub> "	SSI-1105-21T	SSI-1105-21FT
23cm/9"	SSI-1005-23T	SSI-1005-23FT	23cm/9"	SSI-1105-23T	SSI-1105-23FT

Email: [sheffieldsurgicalinstruments@gmail.com](mailto:sheffieldsurgicalinstruments@gmail.com)  
 Web: [www.sheffieldsurgicalinst.com](http://www.sheffieldsurgicalinst.com)

# MICRO NEEDLE HOLDERS

## Jacobson Micro Needle Holder

- Round Bodied
- Tungsten Carbide Jaws
- 1.2mm Jaws



With Lock	Straight	Curved	Without Lock	Straight	Curved
15cm/6"	SSI-1007-15	SSI-1008-15	15cm/6"	SSI-1107-15	SSI-1108-15
18cm/7"	SSI-1007-18	SSI-1008-18	18cm/7"	SSI-1107-18	SSI-1108-18
21cm/8 1/4"	SSI-1007-21	SSI-1008-21	21cm/8 1/4"	SSI-1107-21	SSI-1108-21
23cm/9"	SSI-1007-23	SSI-1008-23	23cm/9"	SSI-1107-23	SSI-1108-23

## Jacobson 'Heavy Style' Needle Holder

- Round Bodied
- Diamond Dusted Jaws
- For Larger Needles - 3/0 size
- Straight Jaws



With Lock		Without Lock	
18cm/7"	SSI-1017-18	18cm/7"	SSI-1117-18
23cm/9"	SSI-1017-23	23cm/9"	SSI-1117-23
25cm/10"	SSI-1017-25	25cm/10"	SSI-1117-25

## **Titanium** Jacobson 'Heavy Style' Needle Holder

- Round Bodied
- Diamond Dusted Jaws
- For Larger Needles - 3/0 size
- Straight Jaws



With Lock		Without Lock	
18cm/7"	SSI-1017-18T	18cm/7"	SSI-1117-18T
23cm/9"	SSI-1017-23T	23cm/9"	SSI-1117-23T
25cm/10"	SSI-1017-25T	25cm/10"	SSI-1117-25T

# MICRO NEEDLE HOLDERS

## Barraquer Micro Needle Holder

- Round Bodied
- 0.4mm Jaws



Without Lock	Straight	Curved
13cm/5"	SSI-BS-13-8	SSI-B-13-8
15cm/6"	SSI-BS-15-8	SSI-B-15-8
18cm/7"	SSI-BS-18-8	SSI-B-18-8

## Castroviejo Micro Needle Holder

- Flat Handed
- 0.4mm Jaws



Without Lock	Curved
14cm/5 1/2"	SSI-C-14
18cm/7"	SSI-C-18

## Double Action Micro Needle Holder

- Round Bodied
- 0.4mm Jaws



Without Lock	Curved
15cm/6"	SSI-15-RM-8
18cm/7"	SSI-18-RM-8

# MICRO NEEDLE HOLDERS

## Yasargil Bayonet Micro Needle Holder

- Flat Handled
- Delicate 1mm Jaws



With Lock	Straight	Curved	Without Lock	Straight	Curved
23cm/9"	SSI-1012-23	SSI-1013-23	23cm/9"	SSI-1112-23	SSI-1113-23

## Bayonet Micro Needle Holder

- Round Bodied
- Delicate 1mm Jaws



With Lock	Straight	Curved	Without Lock	Straight	Curved
21cm/8 1/4"	SSI-1010-21	SSI-1011-21	21cm/8 1/4"	SSI-1110-21	SSI-1111-21
23cm/9"	SSI-1010-23	SSI-1011-23	23cm/9"	SSI-1110-23	SSI-1111-23



# MICRO NEEDLE HOLDERS

## Derf Needle Holder

12cm/4 <sup>3</sup>/<sub>4</sub>" TC



SSI-703DE12

Smooth



SSI-705DE12



## Halsey Needle Holder

13cm/5" TC



SSI-706DE13

Smooth



SSI-704DE13



## Nieverts Needle Holder (offset ring)

13cm/5" TC



SSI-783DE13







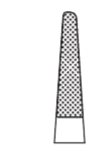

# MICRO NEEDLE HOLDERS

## Mayo Hegar Needle Holder

- Tungsten Carbide Inserts
- Heavy Jaws





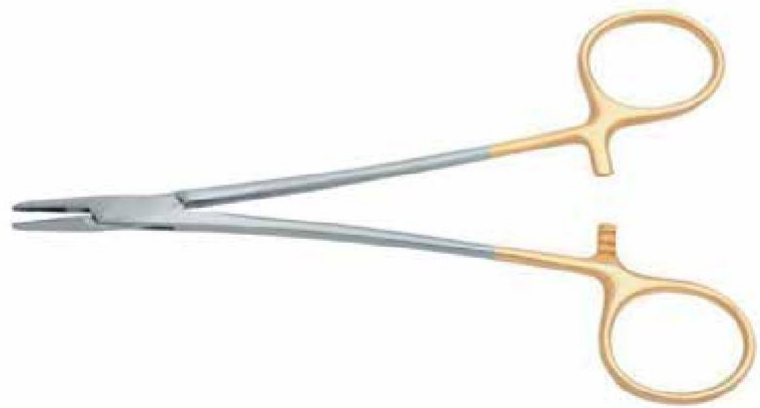

						
<sup>1</sup> / <sub>1</sub>						
14cm/5 <sup>1</sup> / <sub>2</sub> "	16cm/6 <sup>1</sup> / <sub>4</sub> "	18cm/7"	20cm/8"	23cm/9"	26cm/10 <sup>1</sup> / <sub>4</sub> "	30cm/12"
SSI-707DE14	SSI-707DE16	SSI-707DE18	SSI-707DE20	SSI-707DE23	SSI-707DE26	SSI-707DE30

## Crile Wood Needle Holder

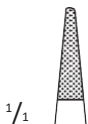
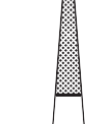
- Tungsten Carbide Inserts
- Fine Jaws

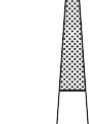

				
<sup>1</sup> / <sub>1</sub>				
15cm/6"	18cm/7"	20cm/8"	23cm/9"	26cm/10 <sup>1</sup> / <sub>4</sub> "
SSI-712DE15	SSI-734DE18	SSI-734DE20	SSI-734DE23	SSI-734DE26

# MICRO NEEDLE HOLDERS

## DeBakey Needle Holder

- Tungsten Carbide Inserts
- Fine Jaws

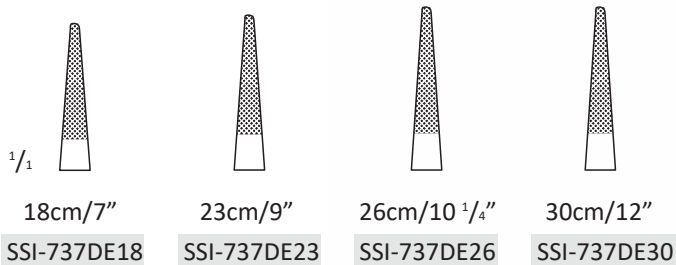

## Micro Vascular Needle Holder

- Tungsten Carbide Inserts
- Slim Delicate Pattern

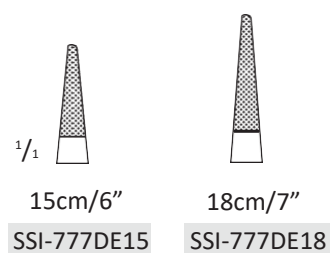





# MICRO NEEDLE HOLDERS

## Micro Ryder Needle Holder

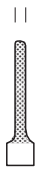
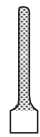
- Tungsten Carbide Inserts







1.4mm     1/1		1.0mm     1/1		
13cm/5"	15cm/6"	18cm/7"	20cm/8"	23cm/9"
SSI-740DE13	SSI-740DE15	SSI-740DE18	SSI-740DE20	SSI-740DE23

## French Eye (Ryder) Needle Holder

- Tungsten Carbide Inserts



1.9mm     1/1			
16cm/6 1/4"	18cm/7"	20cm/8"	26cm/10 1/4"
SSI-739DE16	SSI-739DE18	SSI-739DE20	SSI-739DE26

# MICRO NEEDLE HOLDERS

## Fine Touch Needle Holder

Diamond Dusted Jaws Delicate

1mm Jaws

- For 5/0 Sutures or smaller

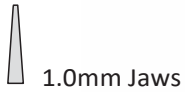

16cm/6 1/4"

SSI-1018-16

18cm/7"

SSI-1018-18

22cm/8 3/4"

SSI-1018-22



## Stratte Needle Holder

- Tungsten Carbide Inserts
- Curved to side
- 23cm/9" length



SSI-732DE23 \*illustrated



SSI-733DE23 Stratte reverse

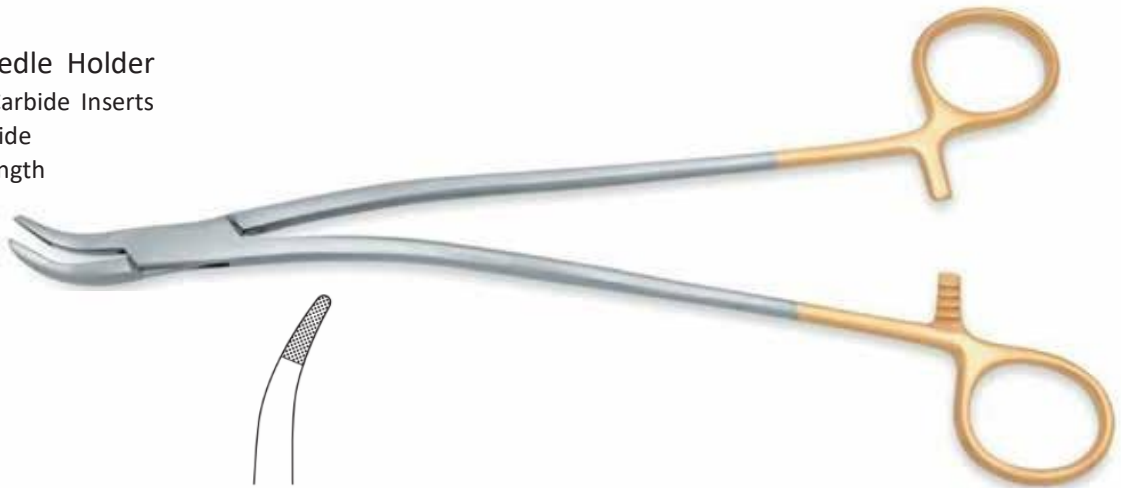

## Berry Sternal Needle Holder

- Tungsten Carbide Inserts

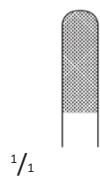

18cm/7"

SSI-803DE18



# MICRO NEEDLE HOLDERS

## DeBakey-Diethrich Atraumatic Tissue Forceps

- Fine 1.5mm Atraumatic Jaws



15cm/6"

20cm/8"

24cm/9 1/2"

SSI-2015-15

SSI-2015-20

SSI-2015-24



1/1



## DeBakey Atraumatic Tissue Forceps



1.5mm Tips

15cm/6"

20cm/8"

24cm/9 1/2"

SSI-2115-15

SSI-2115-20

SSI-2115-24



2mm Tips

15cm/6"

20cm/8"

24cm/9 1/2"

30cm/12"

SSI-2120-15

SSI-2120-20

SSI-2120-24

SSI-2120-30



2.8mm Tips

15cm/6"

20cm/8"

24cm/9 1/2"

30cm/12"

SSI-2128-15

SSI-2128-20

SSI-2128-24

SSI-2128-30



## Titanium DeBakey Atraumatic Tissue Forceps



1.5mm Tips

15cm/6"

20cm/8"

24cm/9 1/2"

SSI-2115-15T

SSI-2115-20T

SSI-2115-24T



2mm Tips

15cm/6"

20cm/8"

24cm/9 1/2"

SSI-2120-15T

SSI-2120-20T

SSI-2120-24T



2.8mm Tips

15cm/6"

20cm/8"

24cm/9 1/2"

SSI-2128-15T

SSI-2128-20T

SSI-2128-24T



# MICRO NEEDLE HOLDERS

## Gillies Dissecting Forceps

- 15cm/6" length
- Toothed

SSI-5160-15

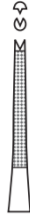

## McIndoes Dissecting Forceps

- 15cm/6" length
- Non-Toothed

SSI-5170-15



## **Titanium** Cushing Dissecting Forceps

- 18cm/7" length
- Serrated 1mm Tips

SSI-2001-18T



## Adson Bayonet Dissecting Forceps

- 19cm/7 1/2" length
- Flat Handled

SSI-2003-19 Serrated tip

SSI-2004-19 Toothed



# MICRO NEEDLE HOLDERS

## Gerald - DeBakey Forceps

- Flat Handled
- 1.2mm DeBakey Tips



17.5cm/6 <sup>3</sup>/<sub>4</sub>" SSI-2110-17  
21cm/8 <sup>1</sup>/<sub>4</sub>" SSI-2110-21

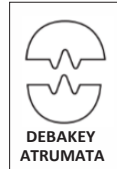

## *Titanium* Gerald- DeBakey Forceps

- Flat Handled
- 1.2mm DeBakey Tips



17.5cm/6 <sup>3</sup>/<sub>4</sub>" SSI-2110-17T  
21cm/8 <sup>1</sup>/<sub>4</sub>" SSI-2110-21T



## Gerald Tissue Forceps

- Flat Handled
- Tungsten Carbide Tips
- 1.2mm Tips



17.5cm/6 <sup>3</sup>/<sub>4</sub>" SSI-2111-17



## Gerald Plain Forceps

- Flat Handled
- Diamond Dusted Tips
- 1mm Tips



17.5cm/6 <sup>3</sup>/<sub>4</sub>" SSI-2114-17





# MICRO NEEDLE HOLDERS

## Gerald Platform Forceps

- Flat Handled
- Tying platform 6 x 1mm
- Diamond Dusted Tips



17.5cm/6 <sup>3</sup>/<sub>4</sub>"  
21cm/8" <sup>1</sup>/<sub>4</sub>

SSI-2113-17  
SSI-2113-21



## **Titanium** Gerald Platform Forceps

- Flat Handled
- Tying platform 6 x 1mm
- Diamond Dusted Tips



17.5cm/6 <sup>3</sup>/<sub>4</sub>"  
21cm/8" <sup>1</sup>/<sub>4</sub>

SSI-2113-17T  
SSI-2113-21T



## Gerald Micro Ring Tip Forceps

- Flat Handled
- 1mm Diamond Dusted Rings



17.5cm/6 <sup>3</sup>/<sub>4</sub>"  
21cm/8" <sup>1</sup>/<sub>4</sub>

SSI-2112-17  
SSI-2112-21



## **Titanium** Gerald Micro Ring Tip Forceps

- Flat Handled
- 1mm Diamond Dusted Rings



17.5cm/6 <sup>3</sup>/<sub>4</sub>"  
21cm/8" <sup>1</sup>/<sub>4</sub>

SSI-2112-17T  
SSI-2112-21T



# MICRO NEEDLE HOLDERS

## Micro Platform Forceps

- Diamond Dusted Tips



18cm/7"

SSI-2201-18

21cm/8" <sup>1</sup>/<sub>4</sub>

SSI-2201-21



## **Titanium** Micro Platform Forceps

- Diamond Dusted Tips



18cm/7"

SSI-2201-18T

21cm/8" <sup>1</sup>/<sub>4</sub>

SSI-2201-21T



## Micro Platform Forceps with Counter Balance

- Diamond Dusted Tips



18cm/7"

SSI-2203-18

21cm/8" <sup>1</sup>/<sub>4</sub>

SSI-2203-21



## **Titanium** Micro Platform Forceps with Counter Balance

- Diamond Dusted Tips



18cm/7"

SSI-2203-18T

21cm/8" <sup>1</sup>/<sub>4</sub>

SSI-2203-21T



Email: [sheffieldsurgicalinstruments@gmail.com](mailto:sheffieldsurgicalinstruments@gmail.com)  
Web: [www.sheffieldsurgicalinst.com](http://www.sheffieldsurgicalinst.com)

# MICRO NEEDLE HOLDERS

## Micro Ring Tip Forceps

- Diamond Dusted 1mm Ring



18cm/7"

SSI-2205-18

21cm/8" <sup>1</sup>/<sub>4</sub>

SSI-2205-21



## **Titanium** Micro Ring Tip Forceps

- Diamond Dusted 1mm Ring



18cm/7"

SSI-2205-18T

21cm/8" <sup>1</sup>/<sub>4</sub>

SSI-2205-21T



## Micro Ring Tip Forceps with Counter Balance

- Diamond Dusted 1mm Ring



18cm/7"

SSI-2206-18

21cm/8" <sup>1</sup>/<sub>4</sub>

SSI-2206-21



## **Titanium** Micro Ring Tip Forceps with Counter Balance

- Diamond Dusted 1mm Ring



18cm/7"

SSI-2206-18T

21cm/8" <sup>1</sup>/<sub>4</sub>

SSI-2206-21T



Email: [sheffieldsurgicalinstruments@gmail.com](mailto:sheffieldsurgicalinstruments@gmail.com)  
Web: [www.sheffieldsurgicalinst.com](http://www.sheffieldsurgicalinst.com)

# MICRO NEEDLE HOLDERS

## DeBakey Micro Forceps

- Round Bodied
- 1mm DeBakey Tips



18cm/7"

SSI-2207-18

21cm/8" <sup>1</sup>/<sub>4</sub>

SSI-2207-21

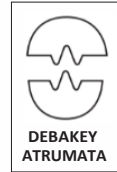

## **Titanium** DeBakey Micro Forceps

- Round Bodied
- 1mm DeBakey Tips



18cm/7"

SSI-2207-18T

21cm/8" <sup>1</sup>/<sub>4</sub>

SSI-2207-21T

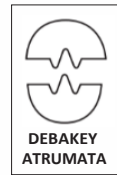

## DeBakey Micro Forceps

- Round Bodied
- 1mm DeBakey Tips
- With Counterbalance



18cm/7"

SSI-2208-18

21cm/8" <sup>1</sup>/<sub>4</sub>

SSI-2208-21

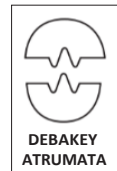

# MICRO NEEDLE HOLDERS

## Bayonet Micro Forceps

- Round Bodied
- Blunt 1mm Tips



21cm/8 1/4"	SSI-2302-21
23cm/9"	SSI-2302-23

## Yasargil Bayonet Micro Forceps

- Flat Handled
- Blunt 1mm Tips



22.5cm/8 1/4"	SSI-2301-22
24cm/9 1/2"	SSI-2301-24

## Yasargil Bayonet Tumor Grasping Forceps

- Flat Handled
- 22.5cm/8 1/4" length



Plain Ring

3mm Ø	SSI-2303-22
5mm Ø	SSI-2304-22



Serrated Ring

3mm Ø	SSI-2307-22
5mm Ø	SSI-2308-22



Toothed Ring

3mm Ø	SSI-2305-22
5mm Ø	SSI-2306-22

# MICRO NEEDLE HOLDERS

## Straight Bipolar Forceps

- 10.5cm/4 <sup>1</sup>/<sub>4</sub>" length



### Tip Size

0.7mm	SSI-7002-38
1mm	SSI-7002-43
Blunt	SSI-7002-41

---

## Straight Bipolar Forceps

- 16.5cm/6 <sup>1</sup>/<sub>2</sub>" length



### Tip Size

0.7mm	SSI-7001-52
1mm	SSI-7001-51

---

## Straight Bipolar Forceps

- 19cm/7 <sup>1</sup>/<sub>2</sub>" length



### Tip Size

0.7mm	SSI-7001-72
1mm	SSI-7001-71

# MICRO NEEDLE HOLDERS

## Bayonet Bipolar Forceps

- 19cm/7 1/2" length



Tip Size

0.7mm	SSI-7001-83
1mm	SSI-7001-81
2mm	SSI-7001-82

## Bayonet Bipolar Forceps

- 22.5cm/8 3/4" length



Tip Size

0.3mm	SSI-7001-90
0.7mm	SSI-7001-91
1.2mm	SSI-7001-92

## Bayonet Bipolar Forceps

- 24cm/9 1/2" length



SSI-7002-90  
SSI-7002-91  
SSI-7002-92

SSI-37-01-35L



- Fitting Block End Forceps
- Banana Plug Vallylab Machine Fitting
- 4.5 metre length

SSI-37-01-38L



- Fitting Block End Forceps
- Erbe BM780 Machine Fitting
- 4.5 metre length

Email: [sheffieldsurgicalinstruments@gmail.com](mailto:sheffieldsurgicalinstruments@gmail.com)  
Web: [www.sheffieldsurgicalinst.com](http://www.sheffieldsurgicalinst.com)

# MICRO NEEDLE HOLDERS

## Bayonet Bipolar Coagulation Forceps

- 22.5cm/8 3/4" length
- Non-Stick Tips
- Mallis 2 Pin Fitting



### Tip Size

0.5mm	SSI-10-5402 AU
0.7mm	SSI-10-5403 AUS/0.7
1.0mm	SSI-10-5403 AU
1.3mm	SSI-10-5403 AUS
1.5mm	SSI-10-5401 AU
2.0mm	SSI-10-5401 AUS

SSI-10-6000 • Fitting Mallis Forceps Banana Plug Fitting



## Bipolar Coagulation Unit BM780 MK II

- 70 Watts
- Foot Switch Control

SSI-36-00-80-01



SSI-36-01-05 Foot Switch



# MICRO NEEDLE HOLDERS

## Bipolar Clamp

- 23cm/9" length
- Curved jaws

SSI-7900-23



While bipolar technique is being used, high frequency current flows between the two ends of the bipolar instrument and focuses only on the small surface of tissue placed between them. There is no dangerous flow of current through the patient's body. This minimises the risk of burns in areas that are distant from the surface being operated on. Bipolar techniques are safer than monopolar techniques.

SSI-731-500

- Bipolar Cable for Bipolar Clamp with 2 banana plugs, 5m length



## Bipolar Scissors

- Curved blades
- Metzenbaum Pattern

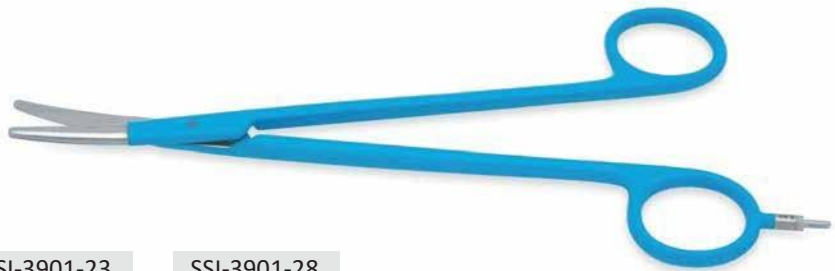

SSI-3901-18

18cm/7"

SSI-3901-21

21cm/8 1/4"

SSI-3901-23

23cm/9"

SSI-3901-28

28cm/11"

## Bipolar Scissors

- Curved slim blades
- Metzenbaum Pattern

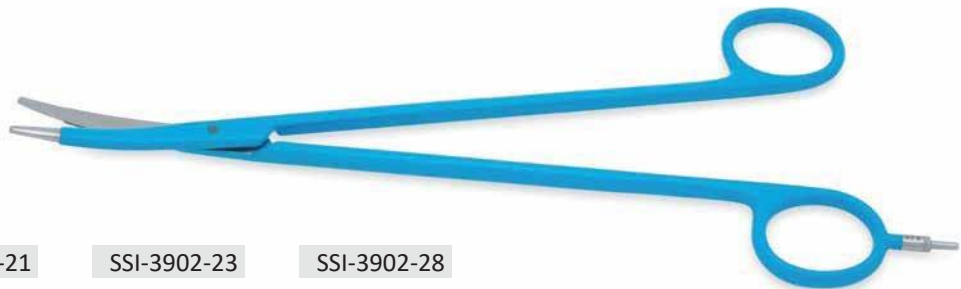

SSI-3902-18

18cm/7"

SSI-3902-21

21cm/8 1/4"

SSI-3902-23

23cm/9"

SSI-3902-28

28cm/11"

## Bipolar Cables

- For use with Bipolar Scissors
- 5 metre cable



SSI-736-005

Valleylab



SSI-737-005

Martin



SSI-739-005

Banana plugs



Email: [sheffieldsurgicalinstruments@gmail.com](mailto:sheffieldsurgicalinstruments@gmail.com)  
 Web: [www.sheffieldsurgicalinst.com](http://www.sheffieldsurgicalinst.com)

# MICRO NEEDLE HOLDERS

## Iris Scissors

- 11.5cm/4 1/2" Straight
- Micro Serrated Cutting Edge

SSI-7612-11

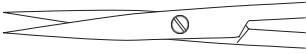

## Iris Scissors

- 11.5cm/4 1/2" Curved
- Micro Serrated Cutting Edge

SSI-7613-11

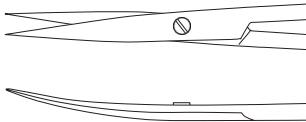

## Strabismus Scissors

- 11.5cm/4 1/2" Straight
- Micro Serrated Cutting Edge

SSI-7622-11



## Strabismus Scissors

- 11.5cm/4 1/2" Curved
- Micro Serrated Cutting Edge

SSI-7623-11



# MICRO NEEDLE HOLDERS

## Stevens Tenotomy Scissors

- 11.5cm/4 1/2" Curved
- Micro Serrated Cutting Edge

SSI-7633-11

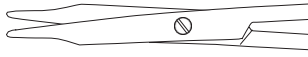

## Stevens-Stille Pattern Tenotomy Scissors

- 12.5cm/5" Curved
- Micro Serrated Cutting Edge
- Larger Oversized Rings

SSI-7633-12



## Jameson-Werber Scissors

- 13.5cm/5 1/4" Curved
- Micro Serrated Cutting Edge

SSI-7643-13



## Jameson Scissors

- 15cm/6" Curved
- Micro Serrated Cutting Edge

SSI-7643-15



## Jameson Scissors

- 15cm/6" Curved
- Strong pattern
- Micro Serrated Cutting Edge

SSI-7645-15



# MICRO NEEDLE HOLDERS

## Slim Baby Metzenbaum Easy-Cut Scissors

- 14cm/5 1/2" Curved
- Micro Serrated Cutting Edge

SSI-7661-14

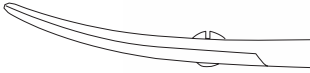

## Slim Metzenbaum Easy-Cut Scissors

- 18cm/7" Curved
- Micro Serrated Cutting Edge

SSI-7661-18

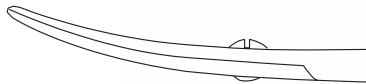

## Baby Metzenbaum Easy-Cut Scissors

- 14cm/5 1/2" Curved
- Micro Serrated Cutting Edge

SSI-7663-14



## McIndoe / Metzenbaum Easy-Cut Scissors

- 18cm/7" Curved
- Micro Serrated Cutting Edge

SSI-7663-18



## Nelson Metzenbaum Easy-Cut Scissors

- 23cm/9" Curved
- Micro Serrated Cutting Edge

SSI-7663-23



Email: [sheffieldsurgicalinstruments@gmail.com](mailto:sheffieldsurgicalinstruments@gmail.com)  
Web: [www.sheffieldsurgicalinst.com](http://www.sheffieldsurgicalinst.com)

# MICRO NEEDLE HOLDERS

## Mayo Easy-Cut Scissors

- 14cm/5 1/2" Straight
- Micro Serrated Cutting Edge

SSI-7652-14



## Mayo Easy-Cut Scissors

- 14cm/5 1/2" Curved
- Micro Serrated Cutting Edge

SSI-7653-14

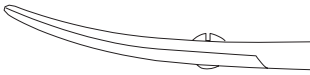

## Mayo Easy-Cut Scissors

- 17cm/6 3/4" Straight
- Micro Serrated Cutting Edge

SSI-7652-17



## Mayo Easy-Cut Scissors

- 17cm/6 3/4" Curved
- Micro Serrated Cutting Edge

SSI-7653-17



# MICRO NEEDLE HOLDERS

## Diethrich Coronary Scissors - **Standard Pattern**

- 18cm/7" length
- Needle Fine Tips
- Polished Fine Blades
- 12mm Blade length

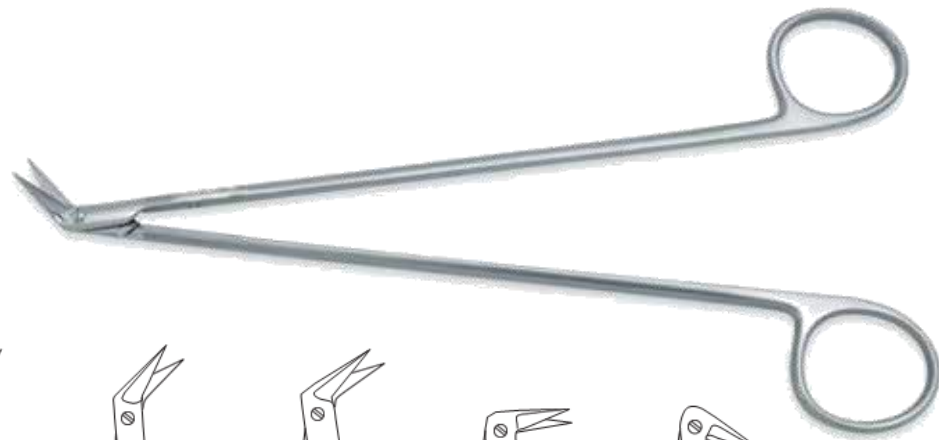

25° angled

SSI-3025-18



45° angled

SSI-3045-18



60° angled

SSI-3060-18



90° angled

SSI-3090-18



125° angled

SSI-3012-18

## Diethrich Coronary Scissors - **Short Fine Blade**

- 18cm/7" length
- Needle Fine Tips
- Precise Polished Blades
- 8mm Blade length



25° angled

SSI-3025-18S



45° angled

SSI-3045-18S



60° angled

SSI-3060-18S



90° angled

SSI-3090-18S



125° angled

SSI-3012-18S

# MICRO NEEDLE HOLDERS

## Diethrich Coronary Scissors - Extra Long Delicate Blades

- 18cm/7" length
- Needle Fine Tips
- Precise Polished Blades
- 15mm Blade length

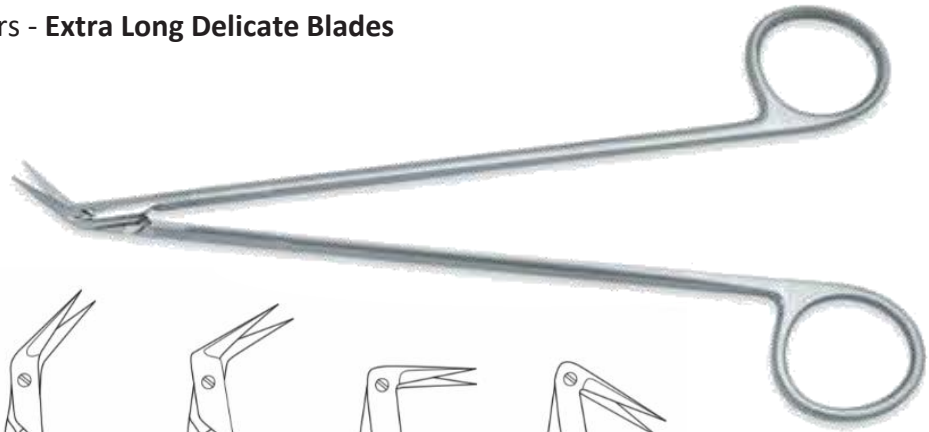

25° angled  
SSI-3025-18L



45° angled  
SSI-3045-18L



60° angled  
SSI-3060-18L



90° angled  
SSI-3090-18L



125° angled  
SSI-3012-18L

## Diethrich Coronary Scissors - with Guide Rail

- 18cm/7" length
- 12mm Blade length

125° angled blades

SSI-3012-18G



## Favaloro Coronary Scissors

- 17cm/6 3/4" length
- 12mm Blade length

125° angled blades

SSI-3113-18



# MICRO NEEDLE HOLDERS

## Potts-Smith Vascular Scissors

- 19cm/7 1/2" length
- Blades angled to side



25° angled

SSI-7625-19

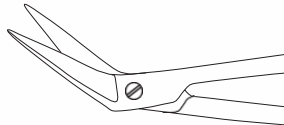

45° angled

SSI-7645-19

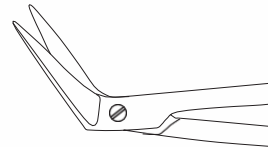

60° angled

SSI-7660-19

## Jacobson Bayonet Micro Scissors

- Flat Handled
- 18cm/7" length



Straight

SSI-3009-18

Curved

SSI-3010-18

## Yasargil Bayonet Micro Scissors

- Flat Handled
- 22.5cm/8 3/4" length



Standard Blade



Straight

SSI-3005-22

Vannas Blade



Straight

SSI-3007-22



Curved

SSI-3006-22



Curved

SSI-3008-22

Email: [sheffieldsurgicalinstruments@gmail.com](mailto:sheffieldsurgicalinstruments@gmail.com)  
 Web: [www.sheffieldsurgicalinst.com](http://www.sheffieldsurgicalinst.com)



# MICRO NEEDLE HOLDERS

## Castroviejo Micro Scissors

- Flat Handed
- 9cm/3" length
- 45° Angled Blades
- 14mm Blade length

SSI-3045-90



## Castroviejo Micro Scissors

- Round Handed
- 11cm/4 1/2" length
- 45° Angled Blades
- 14mm Blade length

SSI-3145-11



## Micro Coronary Scissors - Standard 10mm Blades

- Round Handed - Short length
- 14cm/5 1/2" length
- Blades angled to side



25° angled

SSI-3125-14



45° angled

SSI-3145-14



60° angled

SSI-3160-14



90° angled

SSI-3190-14



125° angled

SSI-3112-14

# MICRO NEEDLE HOLDERS

## Micro Coronary Scissors - **Standard 10mm Blades**

- Round Handled
- 18cm/7" length
- Blades angled to side



25° angled  
SSI-3125-18



45° angled  
SSI-3145-18



60° angled  
SSI-3160-18



90° angled  
SSI-3190-18



125° angled  
SSI-3112-18

---

## Micro Coronary Scissors - **Short Fine 8mm Blades**

- Round Handled
- 18cm/7" length
- Blades angled to side



25° angled  
SSI-3325-18



45° angled  
SSI-3345-18

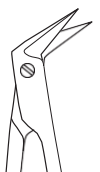

60° angled  
SSI-3360-18



90° angled  
SSI-3390-18



125° angled  
SSI-3312-18



# MICRO NEEDLE HOLDERS

## Micro Coronary Scissors - **Standard 10mm Blades**

- Flat Handed
- 18cm/7" length
- Blades angled to side



25° angled

SSI-3425-18



45° angled

SSI-3445-18



60° angled

SSI-3460-18



90° angled

SSI-3490-18



125° angled

SSI-3412-18

## Micro Coronary Scissors - **Short Fine 8mm Blades**

- Flat Handed
- 18cm/7" length
- Blades angled to side



25° angled

SSI-3625-18



45° angled

SSI-3645-18



60° angled

SSI-3660-18



90° angled

SSI-3690-18



125° angled

SSI-3612-18

Email: [sheffieldsurgicalinstruments@gmail.com](mailto:sheffieldsurgicalinstruments@gmail.com)  
Web: [www.sheffieldsurgicalinst.com](http://www.sheffieldsurgicalinst.com)

# MICRO SCISSORS

## Straight Micro Scissors

- Flat Handled
- 15cm/6" length
- Blades 19mm long

SSI-S-15



Adventitia Scissors with pointed tips

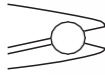

SSI-AS-15T

Available with Micro Serrations for nerve cutting -**Straight**

## Curved Micro Scissors

- Flat Handled
- 15cm/6" length
- Blades 19mm long

SSI-C-15



Dissecting Scissors with rounded tips



SSI-DC-15T

Available with Micro Serrations for nerve cutting -**Curved**

## Straight Micro Scissors

- Flat Handled
- 15cm/6" length
- Blades 15mm long

SSI-S-15S



Adventitia Scissors with pointed tips

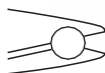

## Curved Micro Scissors

- Flat Handled
- 15cm/6" length
- Blades 15mm long

SSI-C-15S



Dissecting Scissors with rounded tips



# MICRO SCISSORS

## Straight Micro Scissors

- Round Handled
- 15cm/6" length
- Blades 12mm long

SSI-S-15 R8



Adventitia Scissors with pointed tips

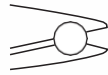

## Curved Micro Scissors

- Round Handled
- 15cm/6" length
- Blades 12mm long

SSI-C-15 R8



Dissecting Scissors with rounded tips

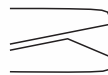

## Straight Micro Scissors

- Round Handled
- 18cm/7" length
- Blades 14mm long

SSI-S-18 R8



Adventitia Scissors with pointed tips

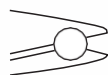

## Curved Micro Scissors

- Round Handled
- 18cm/7" length
- Blades 14mm long

SSI-C-18 R8



Dissecting Scissors with rounded tips



# RIB SPREADERS

## Titanium Neonates Sternal Spreader

- Including 2 pairs of Interchangeable Blades
- 52mm spread, 40mm arm length

SSI-5001-14



Fenestrated  
Blades x2  
10mm width  
15mm depth



Solid  
Blades x2  
20mm width  
15mm depth



## Morse-Favaloro Sternal Spreader

- Double Swivel Blades

Code	Arm length	Blade depth	Size
SSI-5002-12	55mm	12mm	Infant
SSI-5002-13	70mm	13mm	Infant
SSI-5002-14	80mm	14mm	Paediatric
SSI-5002-15	95mm	15mm	Paediatric
SSI-5002-16	110mm	19mm	Adolescent
SSI-5002-19	130mm	19mm	Adolescent
SSI-5002-21	145mm	21mm	Adolescent



## Waterston Rib Spreader

- Infant size

SSI-5003-20



Arm length	Blade width	Blade depth
195mm	40mm	20mm

# RIB SPREADERS

## Finochietto Rib Spreader



Code	Blade width	Blade depth	Spread
SSI-5004-18	21mm	18mm	85mm
SSI-5004-36	45mm	36mm	150mm
SSI-5004-44	65mm	44mm	225mm
SSI-5004-50	60mm	50mm	225mm
SSI-5004-65	65mm	65mm	225mm

## Sellors Rib Spreader

SSI-5011-00

Supplied with set of 3 sizes of Blades and Key

Small Blade	38mm Depth
Medium Blade	45mm Depth
Large Blade	65mm Depth

- Max spread 225mm



38mm Depth  
Small Blade



45mm Depth  
Medium Blade



65mm Depth  
Large Blade



Key

Email: [sheffieldsurgicalinstruments@gmail.com](mailto:sheffieldsurgicalinstruments@gmail.com)  
Web: [www.sheffieldsurgicalinst.com](http://www.sheffieldsurgicalinst.com)

# RIB SPREADERS

## Tuffier Rib Spreader

SSI-5005-50



Blade width    Blade depth

45mm

50mm

## Tudor Edwards Modified Tuffier Rib Spreader

- Complete with key

SSI-5006-35



Blade width    Blade depth

25mm

35mm

Key

## Tudor Edwards Rib Spreader

SSI-5007-00

Supplied with set of 3 sizes of  
Blades and Key

Small Blade	25mm Depth
Medium Blade	50mm Depth
Large Blade	75mmDepth



25mm Depth  
Small Blade



50mm Depth  
Medium Blade



75mm Depth  
Large Blade



Key

Email: [sheffieldsurgicalinstruments@gmail.com](mailto:sheffieldsurgicalinstruments@gmail.com)  
Web: [www.sheffieldsurgicalinst.com](http://www.sheffieldsurgicalinst.com)



# RIB SPREADERS

## Ronald Edwards Rib Spreader

- Curved arms, fenestrated Blades



Code		Blade width	Blade depth	Spread
SSI-5008-50	Medium	30mm	50mm	135mm
SSI-5008-75	Large	65mm	75mm	205mm

## Papworth Rib Spreader

- 225mm spread

SSI-5009-25



Blade width	Blade depth
65mm	25mm

# RIB SPREADERS

## Sellors Rib Approximator and Spreader Combined

- 20cm/8" length

SSI-5010-00



## IMA Rib Retractor

- Complete Set for Internal Mammary Artery Surgery
- Converts left or right side

Complete set includes:

- Frame
- Channelled Blade 100mm
- Claw Blade short 28mm
- Claw Blade long 32mm

SSI-5014-00

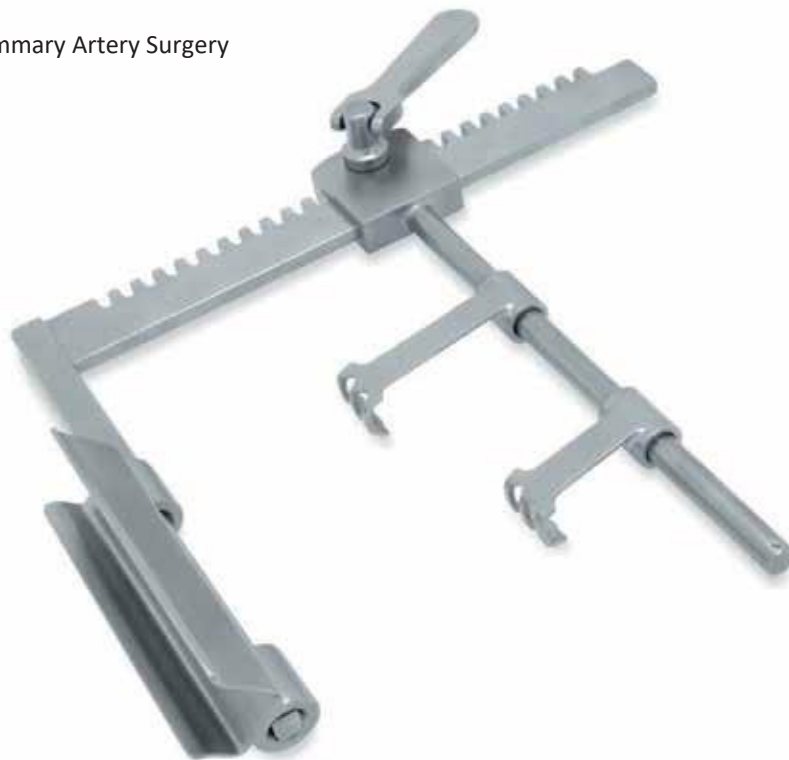

## Channeled Blade

100mm long x 20mm wide



## Claw Blades



Lengths

- 28mm \*
- 32mm \*
- 38mm
- 43mm
- 50mm

\* included in Set

Email: [sheffieldsurgicalinstruments@gmail.com](mailto:sheffieldsurgicalinstruments@gmail.com)  
 Web: [www.sheffieldsurgicalinst.com](http://www.sheffieldsurgicalinst.com)

# RIB SPREADERS

Cooley Cosgrove Mitral Valve Retractor



## SSI-5012-00 Complete Set

Consisting of:

- 1x Cooley Rib Spreader Adult Blades 40mm x 110mm with Cosgrove Mounting Bars
- 1x Main Bracket Attachment
- 3x Universal Clamps
- 1x Side Arm Bar
- 1x Tricuspid Retractor Blade
- 1x Large Retractor Blade
- 3x Small Retractor Blades



Re tractor Blade Large

SSI-5012-01



Re tractor Blade Small

SSI-5012-02

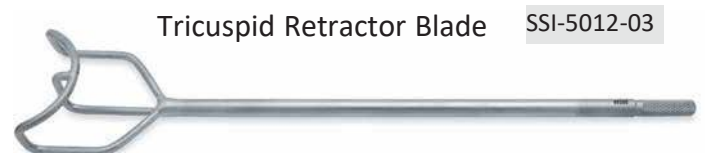

Tricuspid Retractor Blade

SSI-5012-03

Universal Clamp



SSI-5012-06



Main Bracket Attachment

SSI-5012-05

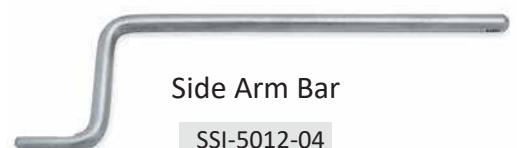

Side Arm Bar

SSI-5012-04

Email: [sheffieldsurgicalinstruments@gmail.com](mailto:sheffieldsurgicalinstruments@gmail.com)  
Web: [www.sheffieldsurgicalinst.com](http://www.sheffieldsurgicalinst.com)

# ABDOMINAL RING RETRACTOR

## Abdominal Ring Retractor System

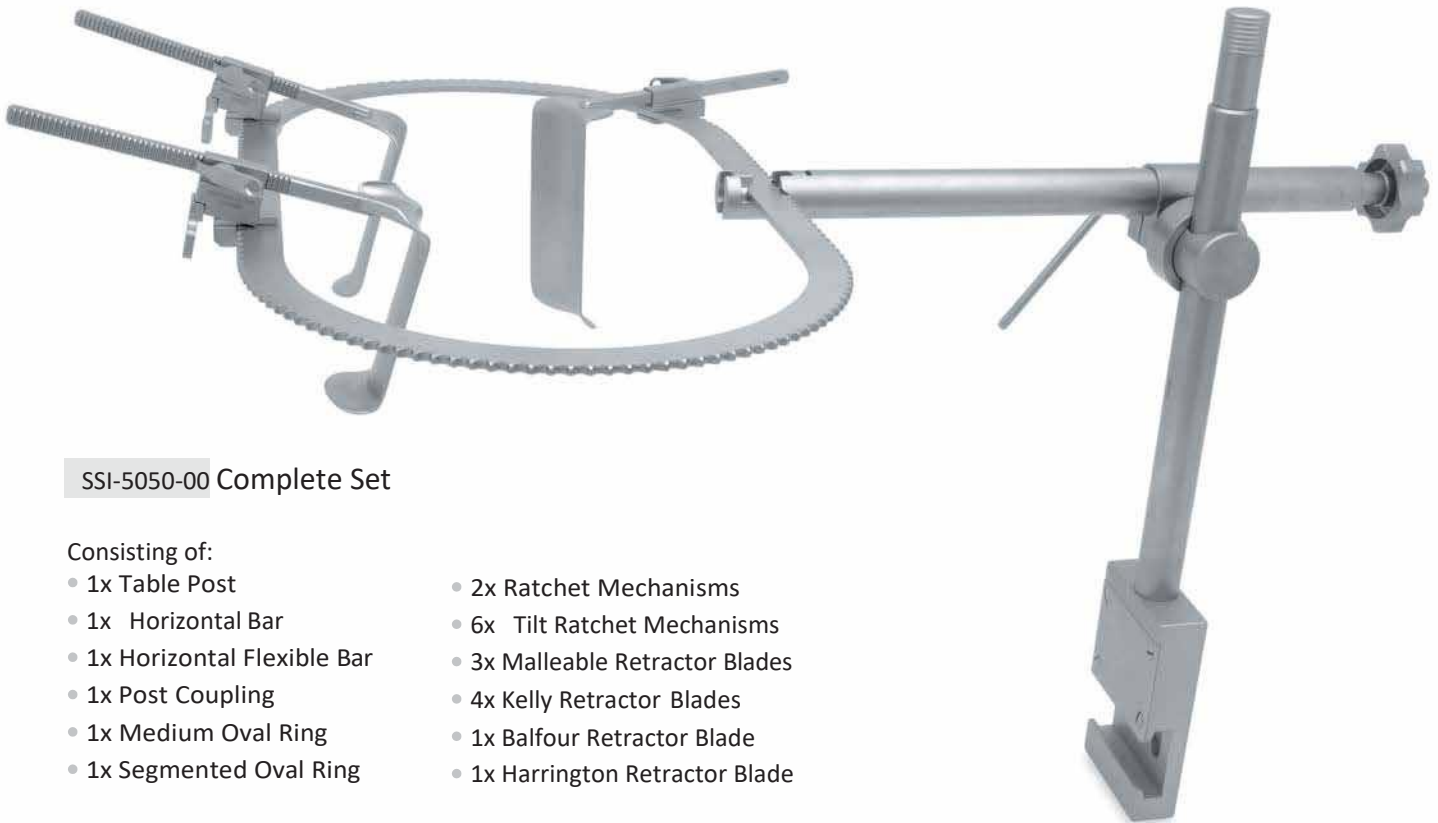

### SSI-5050-00 Complete Set

Consisting of:

- 1x Table Post
- 1x Horizontal Bar
- 1x Horizontal Flexible Bar
- 1x Post Coupling
- 1x Medium Oval Ring
- 1x Segmented Oval Ring
- 2x Ratchet Mechanisms
- 6x Tilt Ratchet Mechanisms
- 3x Malleable Retractor Blades
- 4x Kelly Retractor Blades
- 1x Balfour Retractor Blade
- 1x Harrington Retractor Blade

### Components:

#### Table Post

SSI-5051-00



#### Horizontal Bar

SSI-5052-00



#### Horizontal Flexible Bar

SSI-5053-00



#### Post Coupling

SSI-5054-00



#### Ratchet Mechanism

SSI-5057-00



#### Tilt Ratchet Mechanism

SSI-5058-00



Email: [sheffieldsurgicalinstruments@gmail.com](mailto:sheffieldsurgicalinstruments@gmail.com)  
 Web: [www.sheffieldsurgicalinst.com](http://www.sheffieldsurgicalinst.com)

# ABDOMINAL RING RETRACTOR

## Medium Oval Ring

SSI-5055-00



## Segmented Oval Ring

SSI-5056-00

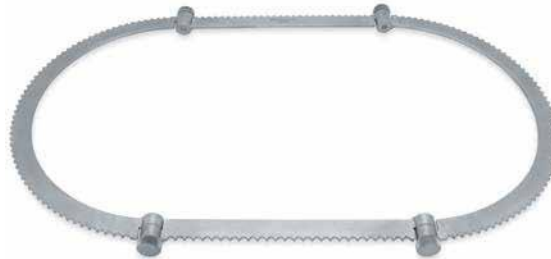

## Malleable Retractor Blades

Code	Blade Size	
	width	depth

SSI-5060-01	38mm	152mm
SSI-5060-02	51mm	152mm
SSI-5060-03	76mm	152mm



## Kelly Retractor Blades

Code	Blade Size	
	width	depth

SSI-5061-01	51mm	76mm
SSI-5061-02	51mm	102mm
SSI-5061-03	51mm	127mm
SSI-5061-04	51mm	154mm



## Balfour Retractor Blade

Code	Blade Size	
	width	depth

SSI-5062-01	67mm	76mm
-------------	------	------



## Harrington Retractor Blade

Code	Blade Size	
	width	depth

SSI-5063-01	63mm	143mm
-------------	------	-------



Email: [sheffieldsurgicalinstruments@gmail.com](mailto:sheffieldsurgicalinstruments@gmail.com)  
 Web: [www.sheffieldsurgicalinst.com](http://www.sheffieldsurgicalinst.com)

# RETRACTORS & HOOKS

## Jacobson Micro Vessel Probe

- 18.5cm/7 1/4"
- Probe with ball tip



SSI-9109-18

## Krayenbühl Nerve and Vessel Hook

- 18.5cm/7 1/4"



SSI-9111-18



SSI-9112-18



SSI-9113-18



SSI-9114-18



## Adson Dural Hook

- 19cm/7 1/2"
- 2mm tip length

Sharp

SSI-9103-19

Blunt

SSI-9104-19



## Cushing Blunt Hook

- 19cm/7 1/2"
- 3mm tip length

SSI-9101-19



## Crile Blunt Hook

- 20cm/8"
- 7mm tip length

SSI-9111-20



## Adson Hook

- 20cm/8"
- 5mm tip length

Sharp

SSI-9101-20

Blunt

SSI-9102-20



## Blalock Blunt Hook

- 24cm/9 1/2"
- 5mm tip length

SSI-9108-24



Email: [sheffieldsurgicalinstruments@gmail.com](mailto:sheffieldsurgicalinstruments@gmail.com)  
Web: [www.sheffieldsurgicalinst.com](http://www.sheffieldsurgicalinst.com)

# RETRACTORS & HOOKS

## Gillies Skin Hook

- 18cm/7"

SSI-5065-01 Small size

SSI-5065-02 Large size



## Klienert-Kutz Skin Hook

- 16cm/6<sup>1</sup>/<sub>4</sub>"

SSI-5055-01



## Ragnell-Davies Retractor

- 14cm/5<sup>1</sup>/<sub>2</sub>"

SSI-5287-14



## Mini-Langenbeck Retractor

- 16cm/6<sup>1</sup>/<sub>4</sub>"

SSI-5242-10 10 x 6mm \*illustrated

SSI-5242-17 17 x 5mm



## Desmarres Saddle Retractor

- 16cm/6<sup>1</sup>/<sub>4</sub>"
- 12mm width

SSI-5235-12



## Senn-Miller Double Ended Catspaw Retractor

- 16cm/6<sup>1</sup>/<sub>4</sub>"

SSI-5289-01 Sharp prongs

SSI-5289-02 Blunt prongs



## Kilner-Miniature Pattern Catspaw Retractor

- 15cm/6"

SSI-5286-01



# RETRACTORS

## Langenbeck Retractor

- 21.5cm/8 1/2"



Code	Blade Size		
	depth	width	
SSI-5122-21	22mm	6mm	Small
SSI-5145-21	45mm	13mm	Medium
SSI-5165-21	65mm	25mm	Large
SSI-5190-21	90mm	20mm	X-large

## Morris Retractor

- 25cm/9 3/4"



Code	Blade Size	
	depth	width
SSI-5201-40	50mm	40mm
SSI-5201-50	50mm	50mm
SSI-5201-65	50mm	65mm
SSI-5202-40	70mm	40mm
SSI-5202-50	70mm	50mm
SSI-5202-65	70mm	65mm

## Deavers Abdominal Retractor



SSI-5100-30	350mm	25mm
SSI-5100-38	300mm	38mm
SSI-5100-50	300mm	50mm
SSI-5100-75	300mm	75mm

Email: [sheffieldsurgicalinstruments@gmail.com](mailto:sheffieldsurgicalinstruments@gmail.com)  
 Web: [www.sheffieldsurgicalinst.com](http://www.sheffieldsurgicalinst.com)



# RETRACTORS

## Tudor Edwards Scapula Retractor

- 20cm/8"
- Toothed blade 50mm x 45mm



SSI-5205-20

## Brompton Erector Spinae Retractor

- Hollow handle
- 20cm/8"
- 2 Prong blades



SSI-5204-20

## Brock Erector Spinae Retractor

- Hollow handle
- 20cm/8"



SSI-5203-20

## Allison Lung Retractor



Code length

SSI-5202-28	Infant	28cm
SSI-5204-28	Child	28cm
SSI-5206-30	Adult	30cm

## Ross Aortic Retractor

- 26cm/10 1/2"



Code width Code width

SSI-5210-10	No.1	SSI-5210-40	No.4
SSI-5210-20	No.2	SSI-5210-50	No.5
SSI-5210-30	No.3	SSI-5210-60	No.6

Email: [sheffieldsurgicalinstruments@gmail.com](mailto:sheffieldsurgicalinstruments@gmail.com)  
 Web: [www.sheffieldsurgicalinst.com](http://www.sheffieldsurgicalinst.com)

# RETRACTORS

## Baby Weitlaner S/R Retractor

- 2 x 3 Blunt Prongs
- 11.5cm/4 1/2"

SSI-5701-10



## Wests S/R Retractor

- 3 x 4 Sharp Prongs
- 14cm/5 1/2"

SSI-4003-14



## Travers S/R Retractor

- 4 x 5 Blunt Prongs
- 20cm/8"

SSI-4004-20



## Norfolk and Norwich S/R Retractor

- 4 x 5 Blunt Prongs
- 20cm/8"

SSI-4000-20



Email: [sheffieldsurgicalinstruments@gmail.com](mailto:sheffieldsurgicalinstruments@gmail.com)  
Web: [www.sheffieldsurgicalinst.com](http://www.sheffieldsurgicalinst.com)

# RIB RASPATORY

## Doyen Periosteal Elevator - Right

SSI-7001-15 Child - 15cm length

SSI-7002-16 Adult - 16.5cm length



## Doyen Periosteal Elevator - Left

SSI-7003-15 Child - 15cm length

SSI-7004-16 Adult - 16.5cm length



## Price Thomas Rib Raspatory

SSI-7005-12 12mm width

SSI-7005-20 20mm width



## Semb Rib Raspatory



No.1  
short shaft,  
notched  
end for rib  
edge,  
200mm

SSI-7006-20



No.2  
long shaft,  
notched  
end for rib  
edge,  
235mm

SSI-7006-23



No.3  
short shaft,  
straight  
end,  
190mm

SSI-7007-19



No.4  
long shaft,  
straight  
end,  
250mm

SSI-7007-25



No.5  
short shaft,  
oval blade,  
220mm

SSI-7008-22



No.6  
short shaft,  
angled oval  
end for back  
of first rib,  
195mm

SSI-7009-19



No.7  
long shaft,  
for edge of  
first rib,  
250mm

SSI-7010-25



No.8  
chisel end for  
disarticulation  
of costo  
vertebral joint,  
200mm

SSI-7011-20

# RIB CUTTERS

## Stille-Liston Bone Cutters

- Double Action
- Straight
- 27cm/10 <sup>3</sup>/<sub>4</sub>"

SSI-1024-27



## Liston-Key-Horsley Bone Cutters

- Double Action
- Angled
- 27cm/10 <sup>3</sup>/<sub>4</sub>"

SSI-1023-27

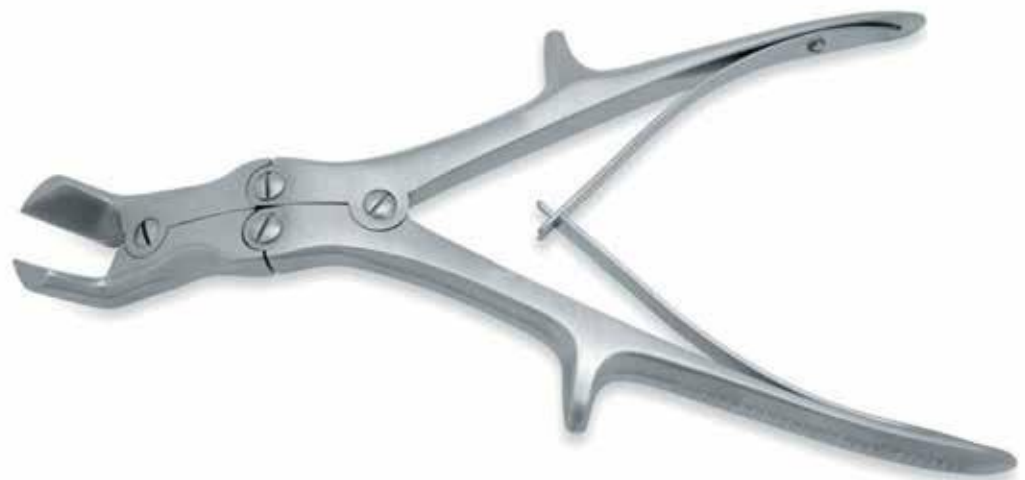

## Tudor Edwards/Vehmehren Costotome

- 24cm/9 <sup>1</sup>/<sub>2</sub>"
- For Cutting Ribs

SSI-1023-24



Email: [sheffieldsurgicalinstruments@gmail.com](mailto:sheffieldsurgicalinstruments@gmail.com)  
Web: [www.sheffieldsurgicalinst.com](http://www.sheffieldsurgicalinst.com)

# WIRE CUTTERS

## Muller Claus Wire Cutters

- 16cm/6"
- Tungsten Carbide Edges
- Cuts wire up to 1.6mm Ø

SSI-8-810E16



## Muller Claus Wire Cutters

- Tungsten Carbide Edges

SSI-8-810E18

- 18cm/7" length (\*illustrated)
- Cuts wire up to 2mm Ø

SSI-8-800E22

- 22cm/8 3/4" length
- Cuts wire up to 3mm Ø



## End Wire Cutters

- 18cm/7" length
- Tungsten Carbide Edges
- Cuts wire up to 1.7mm Ø

SSI-8-816E18



## Muller Claus Wire Pullers

- 18cm/7" length

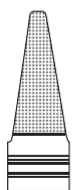

2mm Jaws

SSI-8-818E18

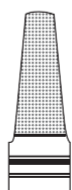

4mm Jaws

SSI-8-820E18



6mm Jaws

SSI-8-821E18



# DISSECTORS

## **Titanium** Micro Round Dissectors

• 19cm/7 1/2"



1mm Small

SSI-8101-19



2mm Medium

SSI-8102-19



3mm Large

SSI-8103-19



## **Titanium** Micro Elevators

• 19cm/7 1/2"



Curved

SSI-8104-19



Angled

SSI-8105-19



## **Titanium** Micro Spatula Dissectors

• 19cm/7 1/2"



1mm Small

SSI-8106-19



1.7mm Medium

SSI-8107-19



2mm Large

SSI-8108-19



## **Titanium** Micro Hooks

• 19cm/7 1/2"



90° Semi-sharp

SSI-8109-19



90° Blunt

SSI-8110-19



45° Semi-sharp

SSI-8111-19



Straight point Needle

SSI-8112-19



## **Titanium** Micro Curettes

• 19cm/7 1/2"



Small Cup

SSI-8113-19



Large Cup

SSI-8114-19



Email: [sheffieldsurgicalinstruments@gmail.com](mailto:sheffieldsurgicalinstruments@gmail.com)  
Web: [www.sheffieldsurgicalinst.com](http://www.sheffieldsurgicalinst.com)

# DISSECTORS

## **Titanium** Micro Ball Dissectors

- 19cm/7 1/2"



Straight

SSI-8115-19



90° 3mm Tip

SSI-8116-19



90° 5mm Tip

SSI-8117-19



40° 4mm Tip

SSI-8118-19



40° 8mm Tip

SSI-8119-19

## Dissector Sterilising Rack

- To hold 19 Micro Dissectors

SSI-8100-00



## Complete Set

- Including Rack and 19 Micro Dissectors

SSI-8100-19

## MacDonalds Dissector

- 19cm/7 1/2"

SSI-7105-19



## Watson Cheyne Dissector

SSI-7203-12 12.5cm/5"

SSI-7203-18 18cm/7"



## Freer Dissector

- 19cm/7 1/2"

SSI-7602-18



# ACL AND MICRO CLAMPS

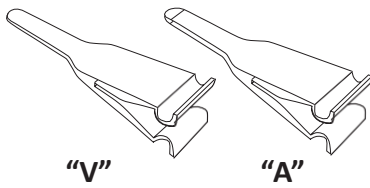

## "A" or "V" Pattern?

Throughout the series, the "V" pattern is the all-purpose clamp, commonly used on all veins, and almost all arteries. The "A" pattern, available in all sizes, is designed for exceptionally thick-walled vessels and slippery arteries. The slight incurve of the tips of the "A" pattern jaw provides extra security against slippage.

- Light and compact design
- Extremely durable
- A unique gripping surface
- Smooth sliding bar action on all approximator clamps
- Clamp profile with parallel sided jaws
- Matt or black finish



Acland  
Clamp Container  
SSI-4400-00

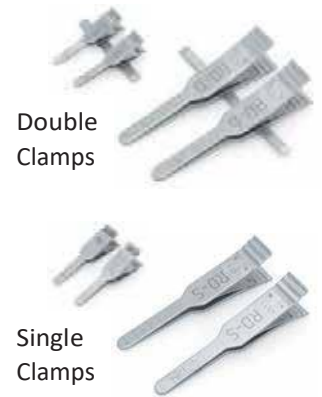

Double  
Clamps

Single  
Clamps

## Ordering details

SINGLE CLAMPS	DOUBLE APPROXIMATING CLAMPS	DOUBLE CLAMPS WITH FRAME
00396 V 00397 A CLAMP SIZE <b>B - 1</b> 0.4 - 1.0mm	00414 V 00415 A CLAMP SIZE <b>ABB - 11</b> 0.4 - 1.0mm	00408 V 00409 A CLAMP SIZE <b>ABB - 1</b> 0.4 - 1.0mm
00398 V 00399 A B - 2 0.6 - 1.5mm	00416 V 00417 A ABB - 2 2 0.6 - 1.5mm	00410 V 00411 A ABB - 2 0.6 - 1.5mm
00400 V 00401 A B - 3 1.0 - 2.25mm	00418 V 00419 A ABB - 3 3 1.0 - 2.25mm	00412 V 00413 A ABB - 3 1.0 - 2.25mm
00325 HD - S 1.5 - 3.5mm	00326 HD - D 1.5 - 3.5mm	Clamp Box CB-1
00286 R D - S 2.0 - 5.0mm	00287 RD - D 2.0 - 5.0mm	Clamp Applicator CAF - 4

Email: [snermeiasurgicalinstruments@gmail.com](mailto:snermeiasurgicalinstruments@gmail.com)  
 Web: [www.sheffieldsurgicalinst.com](http://www.sheffieldsurgicalinst.com)



# DISPOSABLE VESSEL CLAMPS

- Sterile, single use, disposable
- Atraumatic jaws
- Colour coded for better differentiation
- Consistent and reliable closing pressure
- Designed for use on veins and arteries
- Light weight
- Blue, black and purple finish provides excellent contrast in the field
- Radiopaque
- Eliminates cleaning and processing problems
- Economical

## Single Clamps



P - 1  
0.4 - 1mm  
Vessels

SSI-70005



P - 2  
0.6 - 1.5mm  
Vessels

SSI-70003



P - 3  
1.0 - 2.5mm  
Vessels

SSI-70007

## Double Clamps



APP - 11  
0.4 - 1mm  
Vessels

SSI-70006



APP - 2 2  
0.6 - 1.5mm  
Vessels

SSI-70004



APP - 3 3  
1.0 - 2.5mm  
Vessels

SSI-70008

# VISIBILITY BACKGROUND MATERIAL

## TO ASSIST IN VISUALISING MICRO VESSELS DURING SURGERY

Application: For use in Micro Surgical Anastomosis of Micro Vessels under a Microscope to allow the surgeon to better visualize the detail of the vessels, being closed.

The Visibility Material can be used either with the Grid side up to give the Surgeon a scale of the vessel alternatively the reverse Plain side can also be used.

The material has a non reflective surface eliminating distractions from theatre lighting and has a non-tacky finish to aid mobilization of the Vessel.

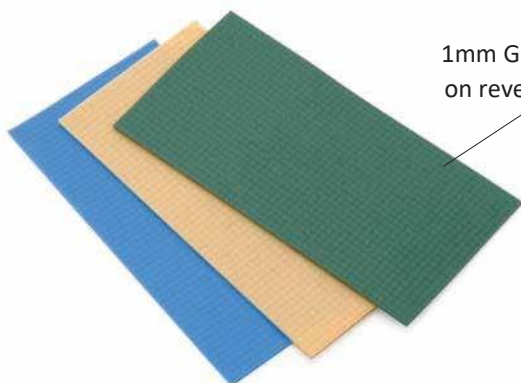

1mm Grid one side & matt finish on reverse. Size: 50mm x 25mm

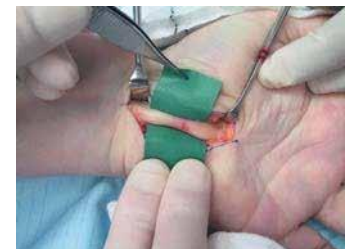
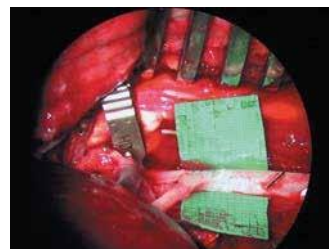

Ordering details:

COLOUR	ordering code
Yellow	<b>VB2</b>
Green	<b>VB3</b>
Blue	<b>VB4</b>

- X-Ray opaque silicon material
- 1mm Grid for accurate measurement of vessels
- Latex Free material
- Sterile Packed in boxes of 12 pieces

Email: [sheffieldsurgicalinstruments@gmail.com](mailto:sheffieldsurgicalinstruments@gmail.com)  
Web: [www.sheffieldsurgicalinst.com](http://www.sheffieldsurgicalinst.com)

# BULLDOG CLAMPS

## Diethrich Mini Bulldog Clamps

- Straight
- Weight 3gr
- Closing pressure 80gr



Overall length  
Jaw length

50mm  
8mm

Code SSI-4001-50



Overall length  
Jaw length

55mm  
12mm

Code SSI-4001-55



Overall length  
Jaw length

60mm  
16mm

Code SSI-4001-60



Overall length  
Jaw length

65mm  
20mm

Code SSI-4001-65

## Diethrich Mini Bulldog Clamps

- Angled
- Weight 3gr
- Closing pressure 80gr



Overall length  
Jaw length

43mm  
8mm

Code SSI-4002-43

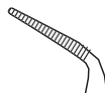

Overall length  
Jaw length

45mm  
12mm

Code SSI-4002-45

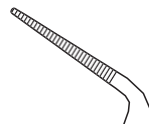

Overall length  
Jaw length

50mm  
16mm

Code SSI-4002-50

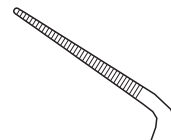

Overall length  
Jaw length

55mm  
20mm

Code SSI-4002-55

# BULLDOG CLAMPS

## DeBakey-Diethrich Mini Bulldog Clamps

- Straight
- Weight 3gr
- Closing pressure 180gr

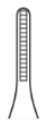

47mm  
10mm

SSI-4005-47

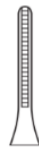

51mm  
14mm

SSI-4005-51



57mm  
20mm

SSI-4005-57

Overall length  
Jaw length

Code

## DeBakey-Diethrich Mini Bulldog Clamps

- Angled
- Weight 3gr
- Closing pressure 180gr



44mm  
10mm

SSI-4006-44

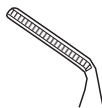

46mm  
14mm

SSI-4006-46

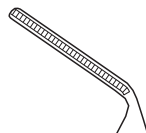

49mm  
20mm

SSI-4006-49

Overall length  
Jaw length

Code





# BULLDOG CLAMPS

Low Closing Pressure for Veins 110gr marked with V  
 High Closing Pressure for Arteries 220gr marked with A

## Titanium Mini Glover Bulldog Clamps

- Straight
- Weight 0.8gr







				
Overall length	30mm	35mm	40mm	50mm
Jaw length	11mm	15mm	17mm	24mm
Vein	SSI-4009-30T	SSI-4009-35T	SSI-4009-40T	SSI-4009-50T
Low Closing Pressure				
Arterial	SSI-4010-30T	SSI-4010-35T	SSI-4010-40T	SSI-4010-50T
High Closing Pressure				

## Titanium Mini Glover Bulldog Clamps

- Curved
- Weight 0.8gr





				
Overall length	30mm	35mm	40mm	50mm
Jaw length	11mm	15mm	17mm	24mm
Vein	SSI-4011-30T	SSI-4011-35T	SSI-4011-40T	SSI-4011-50T
Low Closing Pressure				
Arterial	SSI-4012-30T	SSI-4012-35T	SSI-4012-40T	SSI-4012-50T
High Closing Pressure				

## Titanium Mini Glover Bulldog Clamps

- Strongly Curved
- Weight 0.8gr

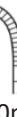

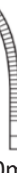
				
Overall length	30mm	35mm	40mm	50mm
Jaw length	11mm	15mm	17mm	24mm
Vein	SSI-4013-30T	SSI-4013-35T	SSI-4013-40T	SSI-4013-50T
Low Closing Pressure				
Arterial	SSI-4014-30T	SSI-4014-35T	SSI-4014-40T	SSI-4014-50T
High Closing Pressure				

Email: [sheffieldsurgicalinstruments@gmail.com](mailto:sheffieldsurgicalinstruments@gmail.com)  
 Web: [www.sheffieldsurgicalinst.com](http://www.sheffieldsurgicalinst.com)

# BULLDOG CLAMPS

## Glover Bulldog Clamps

- Straight
- Closing Pressure adjustable



Overall length  
Jaw length

50mm  
20mm

68mm  
30mm

85mm  
43mm

105mm  
56mm

Code

SSI-4007-50

SSI-4007-68

SSI-4007-85

SSI-4007-05

## Glover Bulldog Clamps

- Curved
- Closing Pressure adjustable



Overall length  
Jaw length

46mm  
20mm

64mm  
30mm

78mm  
43mm

100mm  
56mm

Code

SSI-4008-50

SSI-4008-68

SSI-4008-85

SSI-4008-05

## Mini-Glover Bulldog Clamps

- Weight 12g



Overall length  
Jaw length

35mm  
14mm

35mm  
14mm

35mm  
14mm

35mm  
14mm

Code

SSI-4015-35

SSI-4025-35

SSI-4035-35

SSI-4045-35

Email: [sheffieldsurgicalinstruments@gmail.com](mailto:sheffieldsurgicalinstruments@gmail.com)  
Web: [www.sheffieldsurgicalinst.com](http://www.sheffieldsurgicalinst.com)

# BULLDOG CLAMPS

## Glover Bulldog Clamps

- Angled
- 55mm length Jaws

SSI-4056-55



## DeBakey - Satinsky Bulldog Clamps

- Curved
- 55mm length Jaws

SSI-4057-55



## DeBakey Carotid Bulldog Clamps

- Curved
- 90mm length Jaws

SSI-4058-90



## DeBakey-Satinsky Bulldog Clamps

- Curved
- 100mm length Jaws

SSI-4059-10



Email: [sheffieldsurgicalinstruments@gmail.com](mailto:sheffieldsurgicalinstruments@gmail.com)  
Web: [www.sheffieldsurgicalinst.com](http://www.sheffieldsurgicalinst.com)

# BULLDOG CLAMPS

Gregory 'Soft' Carotid Bulldog Clamps



Overall length  
Jaw length  
Code

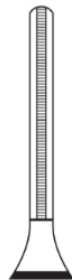

90mm  
27mm

SSI-4050-90

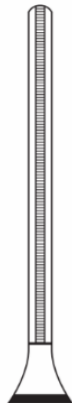

110mm  
44mm

SSI-4051-11

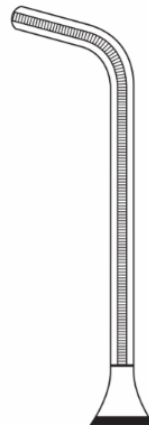

105mm  
55mm

SSI-4052-10

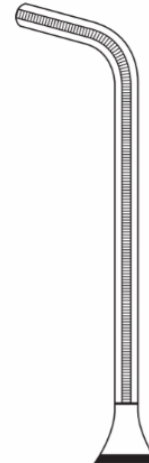

110mm  
60mm

SSI-4053-11

## Modified Gregory 'Soft' Bulldog Clamps

- Curved
- Weight 12g



Overall length  
Jaw length  
Code



110mm  
60mm

SSI-4054-11

curved to left



110mm  
60mm

SSI-4055-11

curved to right

# BULLDOG CLAMPS

## DeBakey Bulldog Clamps

- Straight



Overall length  
Jaw length

Code

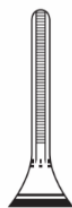

80mm  
20mm

SSI-4003-08

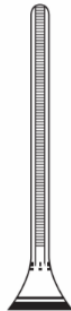

90mm  
30mm

SSI-4003-09

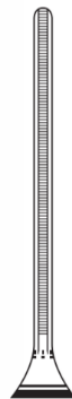

105mm  
45mm

SSI-4003-10

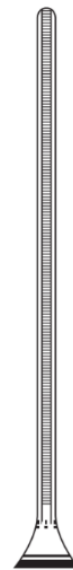

125mm  
68mm

SSI-4003-12

## DeBakey Bulldog Clamps

- Curved

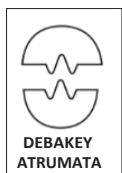

Overall length  
Jaw length

Code

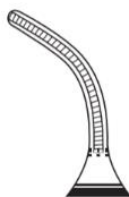

75mm  
20mm

SSI-4004-08

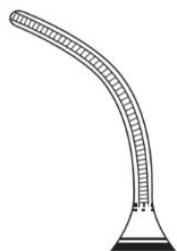

85mm  
30mm

SSI-4004-09

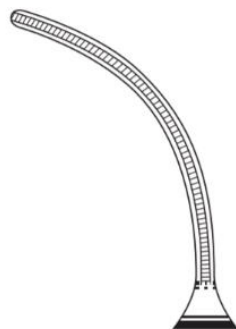

95mm  
45mm

SSI-4004-10

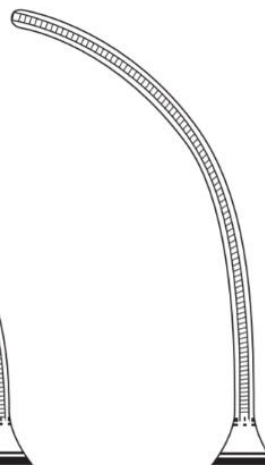

115mm  
68mm

SSI-4004-12



# BULLDOG CLAMPS

## Titanium DeBakey Bulldog Clamps

- Straight

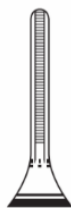

80mm  
20mm

SSI-4003-08T

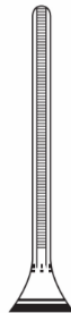

90mm  
30mm

SSI-4003-09T

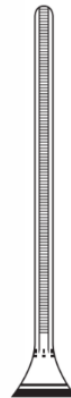

105mm  
45mm

SSI-4003-10T

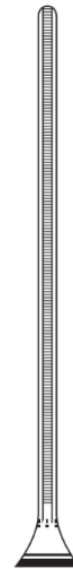

125mm  
68mm

SSI-4003-12T

Overall length  
Jaw length

Code

## Titanium DeBakey Bulldog Clamps

- Curved

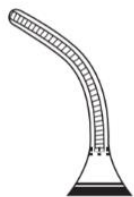

75mm  
20mm

SSI-4004-08T

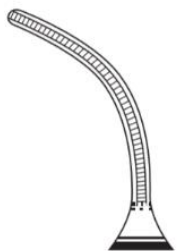

85mm  
30mm

SSI-4004-09T

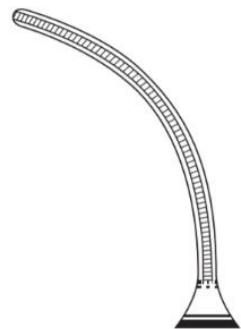

95mm  
45mm

SSI-4004-10T

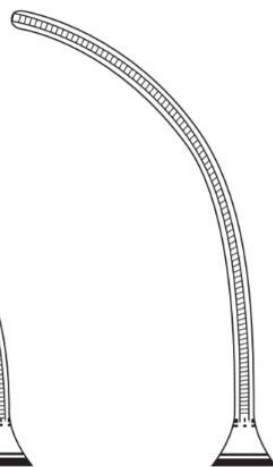

115mm  
68mm

SSI-4004-12T

Overall length  
Jaw length

Code

Email: [sheffieldsurgicalinstruments@gmail.com](mailto:sheffieldsurgicalinstruments@gmail.com)  
Web: [www.sheffieldsurgicalinst.com](http://www.sheffieldsurgicalinst.com)

# VASCULAR CLAMPS

## **Titanium** DeBakey Paediatric Clamp

- 10.5cm/4" length
- Straight Jaws/Angled Shanks

SSI-6010-10T



## **Titanium** DeBakey Paediatric Clamp

- 10.5cm/4" length

SSI-6011-10T Jaws angled 30°

SSI-6012-10T Jaws angled 45°

SSI-6013-10T Jaws angled 60°



## **Titanium** DeBakey Paediatric Clamp

- 10.5cm/4" length
- Jaws 6mm x 10.5mm

SSI-6014-10T



## **Titanium** DeBakey Paediatric Clamp

- 10.5cm/4" length
- Jaws 6mm x 10.5mm

SSI-6015-10T



## **Titanium** DeBakey Paediatric Clamp

- 10.5cm/4" length
- Jaws 9mm x 10.5mm

SSI-6016-10T



# VASCULAR CLAMPS

## DeBakey Castaneda Paediatric Clamp

- Curved shanks
- Suitable for Paediatric and delicate surgery
- 12cm/5" length



SSI-6301-12

Straight

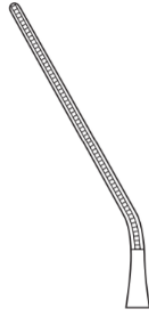

SSI-6302-12

Angled 25°

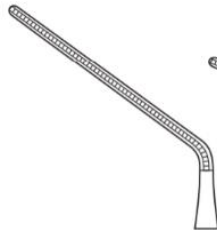

SSI-6303-12

Angled 45°

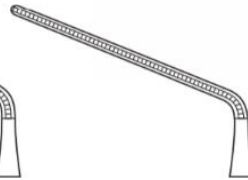

SSI-6304-12

Angled 60°

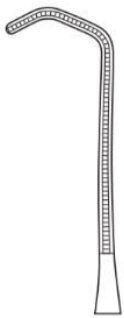

SSI-6305-12

Anastomosis



SSI-6306-12

Anastomosis

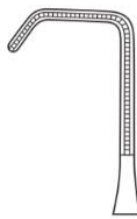

SSI-6307-12

Anastomosis 90°

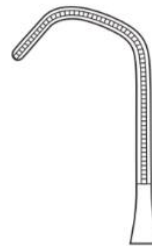

SSI-6308-12 \*

Satinsky

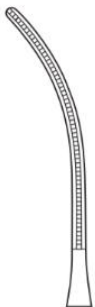

SSI-6309-12

Light curve



SSI-6310-12

Spoon shaped



SSI-6311-12

Strong curve



SSI-6312-12

Carotid



# VASCULAR CLAMPS

## DeBakey Ring Handled Bulldog Clamp

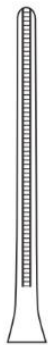

SSI-6041-12 straight  
12.5cm/5"

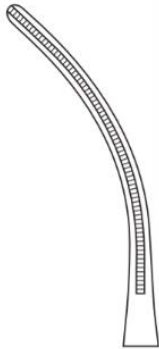

SSI-6042-12 curved  
12.5cm/5"

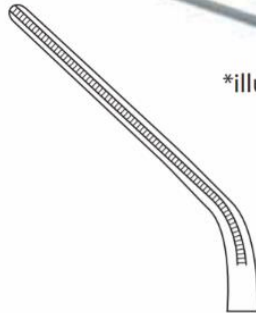

SSI-6043-12 \* angled 45°  
12.5cm/5"

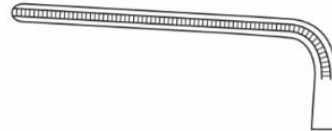

SSI-6044-12 angled 90°  
10cm/4"

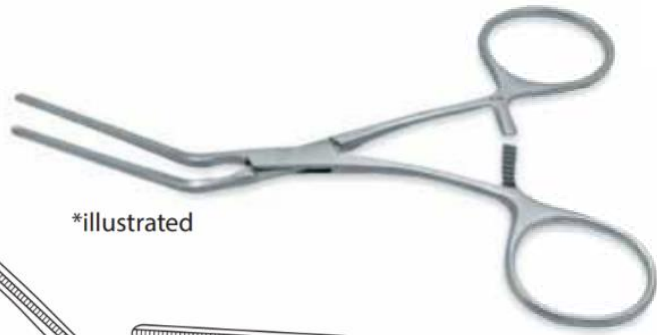

\*illustrated

## DeBakey-Glover Anastomosis Clamp

- Straight shanks

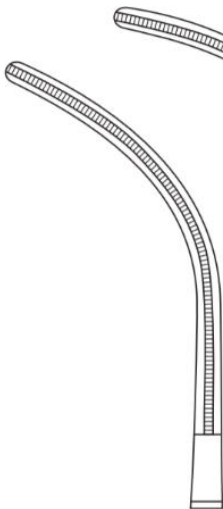

SSI-6020-21  
21cm/8 1/4"

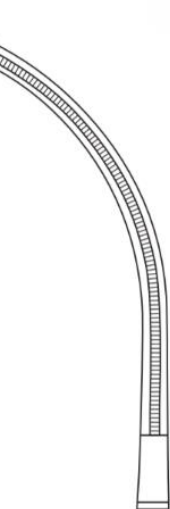

SSI-6021-24  
24cm/9 1/2"

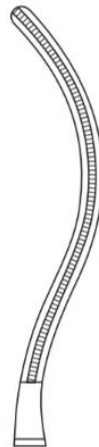

SSI-6022-21  
21cm/8 1/4"



SSI-6023-26  
26cm/10 1/4"

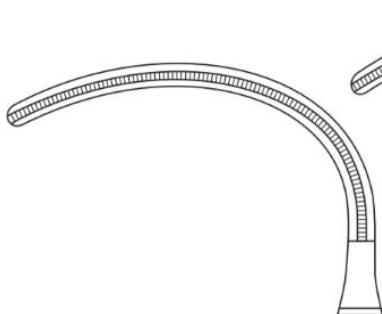

SSI-6024-18  
18.5cm/7 1/4"

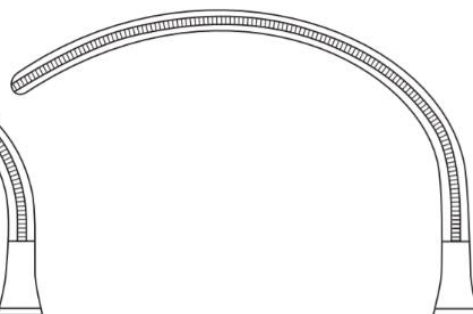

SSI-6025-22  
22cm/8 3/4"



Email: [sheffieldsurgicalinstruments@gmail.com](mailto:sheffieldsurgicalinstruments@gmail.com)  
Web: [www.sheffieldsurgicalinst.com](http://www.sheffieldsurgicalinst.com)

# VASCULAR CLAMPS

## Lambert-Kay Aortic Clamp

- 20cm/8" length

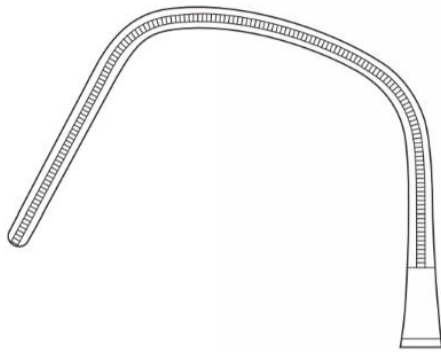

SSI-6030-20

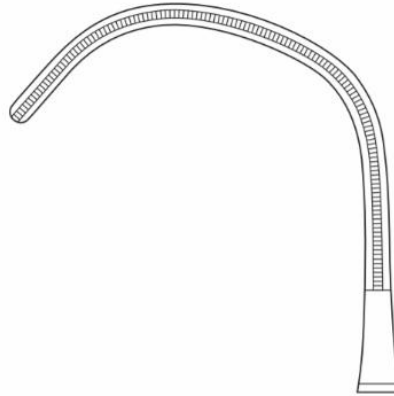

SSI-6030-21



## Weber Aortic Clamp

- 26cm/10 1/4" length

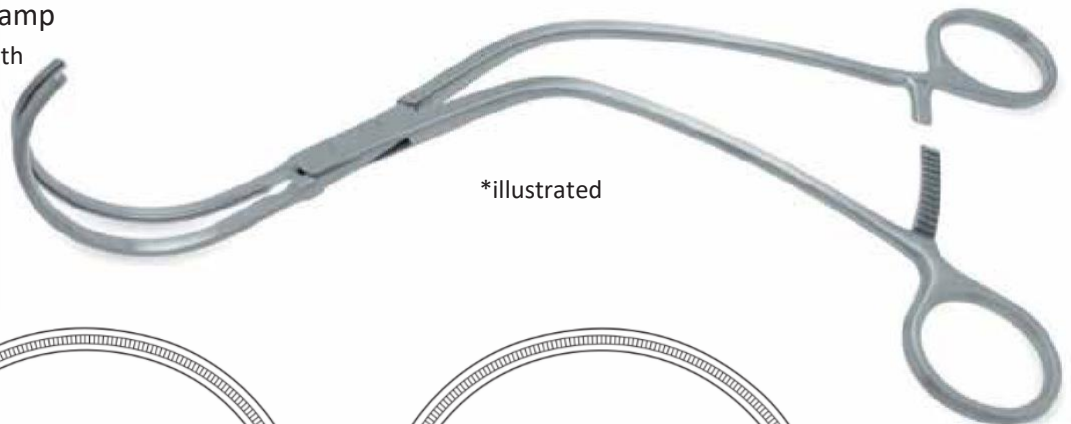

\*illustrated

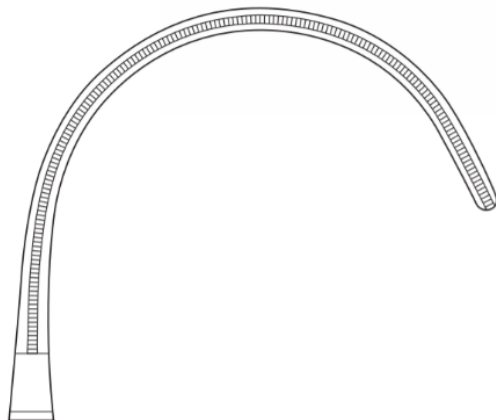

SSI-6031-26 \* Left curved

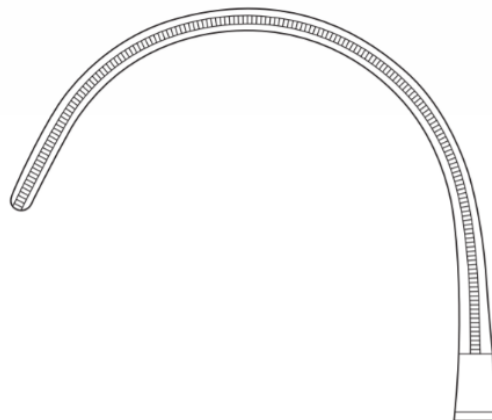

SSI-6032-26 Right curved



# VASCULAR CLAMPS

## DeBakey Aortic Aneurism Clamp

- Curved Shanks



24cm/9<sup>1</sup>/<sub>2</sub>"  
SSI-6035-24

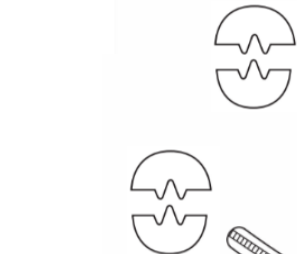

27cm/10<sup>1</sup>/<sub>4</sub>"  
SSI-6035-27

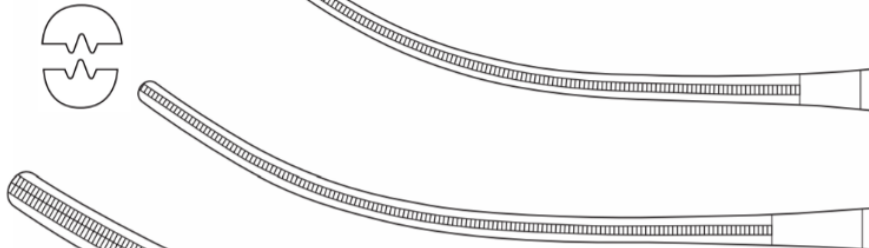

31cm/12<sup>1</sup>/<sub>4</sub>"  
SSI-6035-31

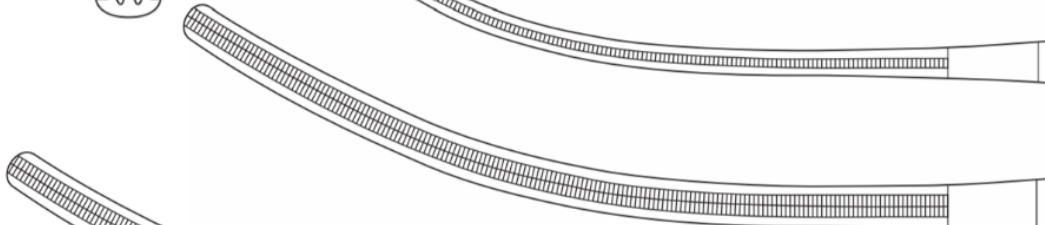

33cm/13"  
SSI-6035-33

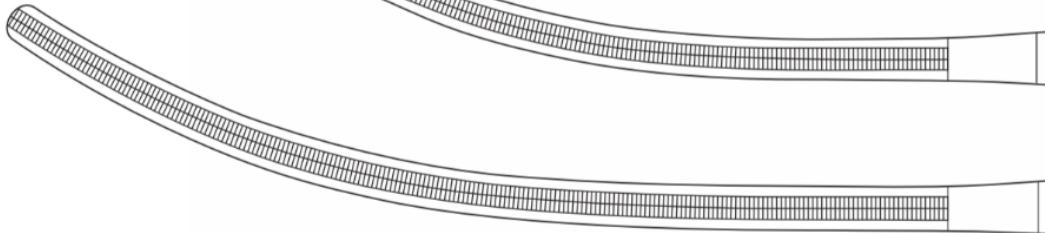

## DeBakey-Bahnsen Aortic Aneurism Clamp

- S-Shape Shanks



24.5cm/9<sup>3</sup>/<sub>4</sub>"  
SSI-6037-24

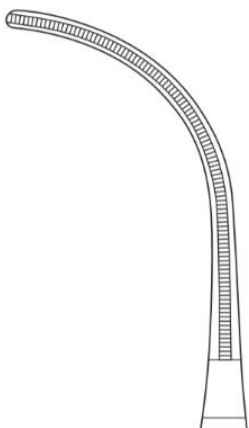

25.5cm/10"  
SSI-6037-25

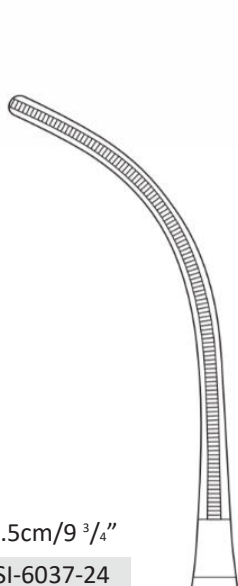

26.5cm/10<sup>1</sup>/<sub>2</sub>"  
SSI-6037-26

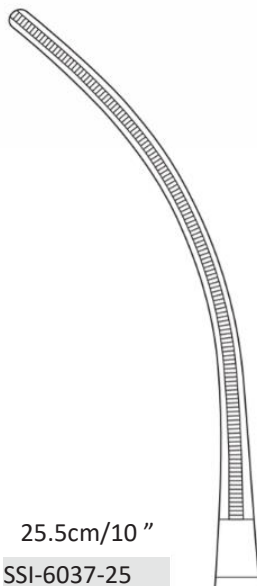

Email: [sheffieldsurgicalinstruments@gmail.com](mailto:sheffieldsurgicalinstruments@gmail.com)  
Web: [www.sheffieldsurgicalinst.com](http://www.sheffieldsurgicalinst.com)

# VASCULAR CLAMPS

## DeBakey Glover Patent Ductus Clamp

- Straight Shanks

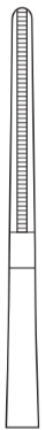

20cm/8"  
SSI-6039-20

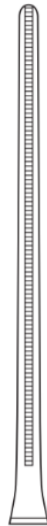

22cm/8 3/4"  
SSI-6039-22

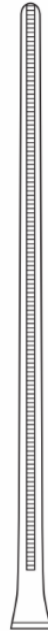

26cm/10 1/4"  
SSI-6039-26



## DeBakey Glover Patent Ductus Clamp

- Angled Shanks



20cm/8"  
SSI-6040-20



22cm/8 3/4"  
SSI-6040-22



26cm/10 1/4"  
SSI-6040-26

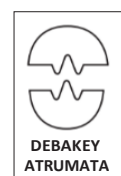

# VASCULAR CLAMPS

## DeBakey Peripheral Clamp



\*illustrated

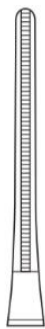

Straight Shanks \*  
19.5cm/7 <sup>3</sup>/<sub>4</sub>"

SSI-6042-19

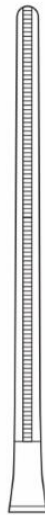

Straight Shanks  
22cm/8 <sup>3</sup>/<sub>4</sub>"

SSI-6042-22

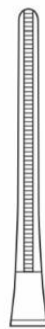

Angled Shanks  
19.5cm/7 <sup>3</sup>/<sub>4</sub>"

SSI-6044-19



Angled Shanks  
22cm/8 <sup>3</sup>/<sub>4</sub>"

SSI-6044-22



## DeBakey Peripheral Clamp

- Curved Shanks
- Angled 45°

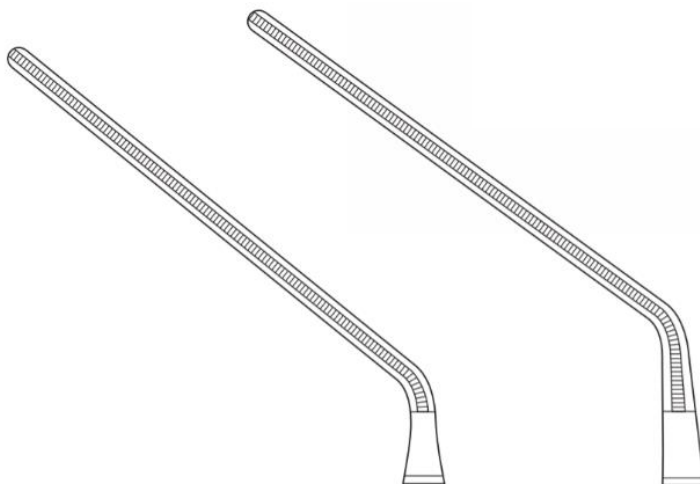

19cm/7 <sup>1</sup>/<sub>2</sub>"

SSI-6045-19

26cm/8 <sup>1</sup>/<sub>2</sub>"

SSI-6045-26



Email: [sheffieldsurgicalinstruments@gmail.com](mailto:sheffieldsurgicalinstruments@gmail.com)  
Web: [www.sheffieldsurgicalinst.com](http://www.sheffieldsurgicalinst.com)



# VASCULAR CLAMPS

## DeBakey Peripheral Clamp

- S- Shaped

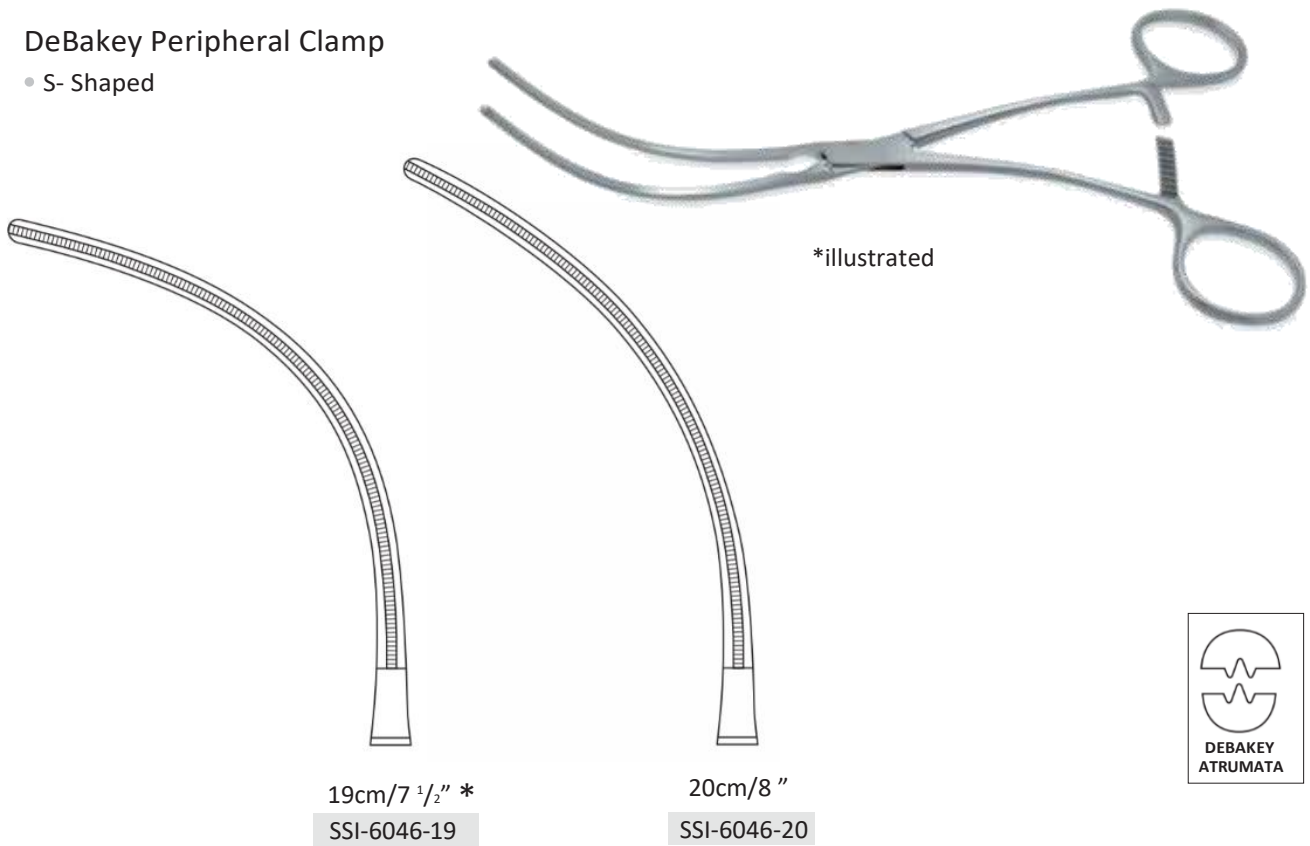

## Leland-Jones Peripheral Vascular Clamp

- Straight Shanks

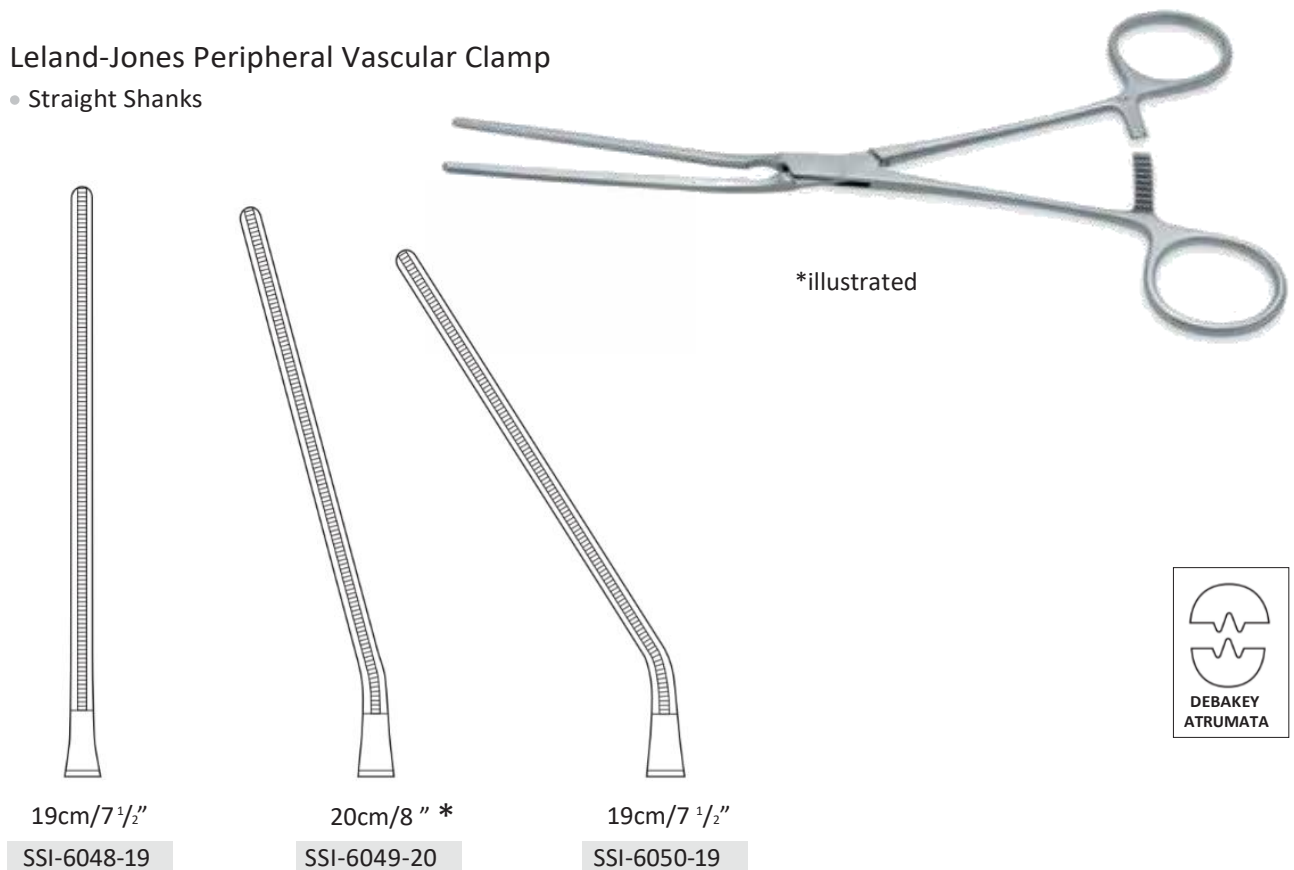

# VASCULAR CLAMPS

## DeBakey Multi-Purpose Clamp

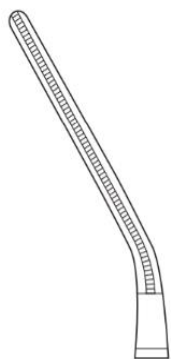

SSI-6055-16 \*  
16cm/6 1/4"  
30° Angled Jaws

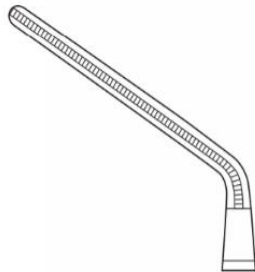

SSI-6055-15  
15.5cm/6"  
60° Angled Jaws

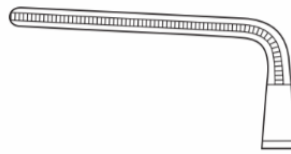

SSI-6055-14  
14.5cm/6 1/2"  
90° Angled Jaws

\*illustrated



## DeBakey Multi-Purpose Forceps

- Angled 60°
- Curved Shanks



\*illustrated

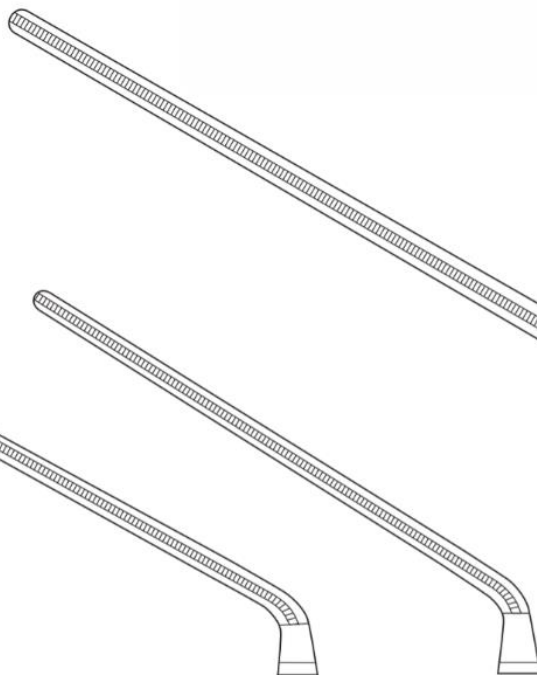

SSI-6052-20  
20cm/8"

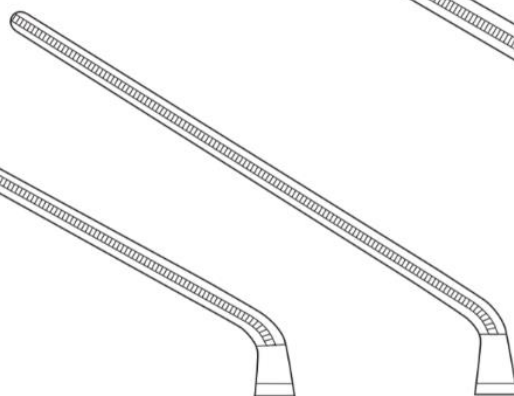

SSI-6052-24 \*  
24cm/9 1/2"

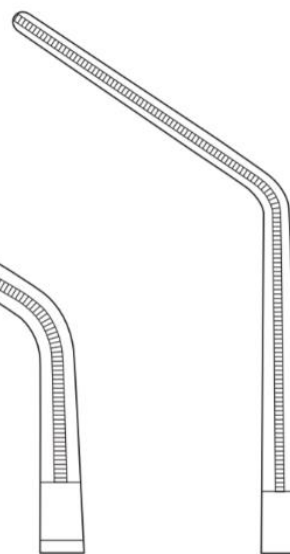

SSI-6052-30  
30cm/12"

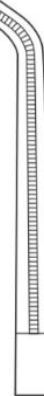

SSI-6052-25  
25cm/10"



# VASCULAR CLAMPS

## DeBakey Multi-Purpose Clamp

- Angled 90°

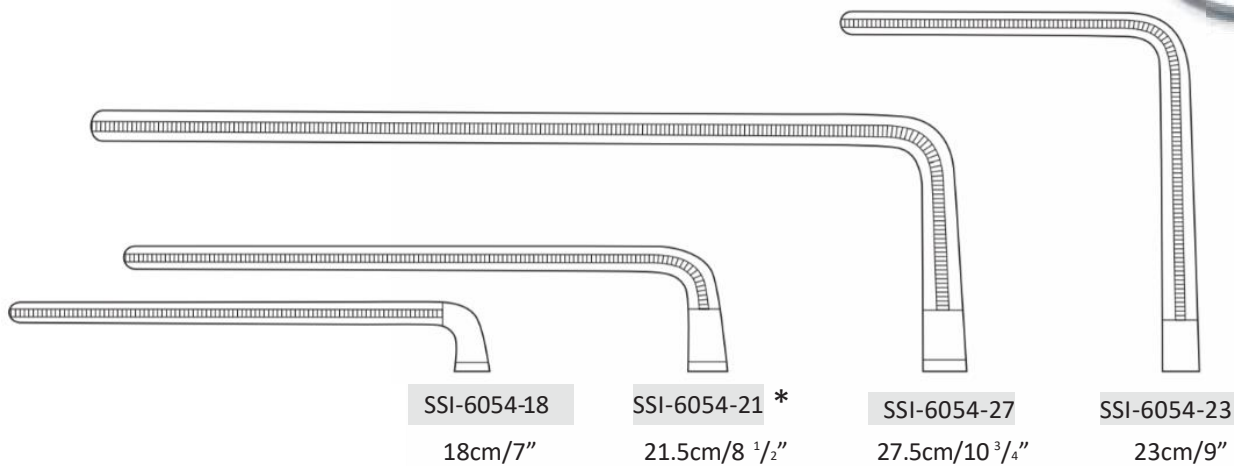

## DeBakey-Beck Paediatric Aortic Forceps

- Straight Shanks

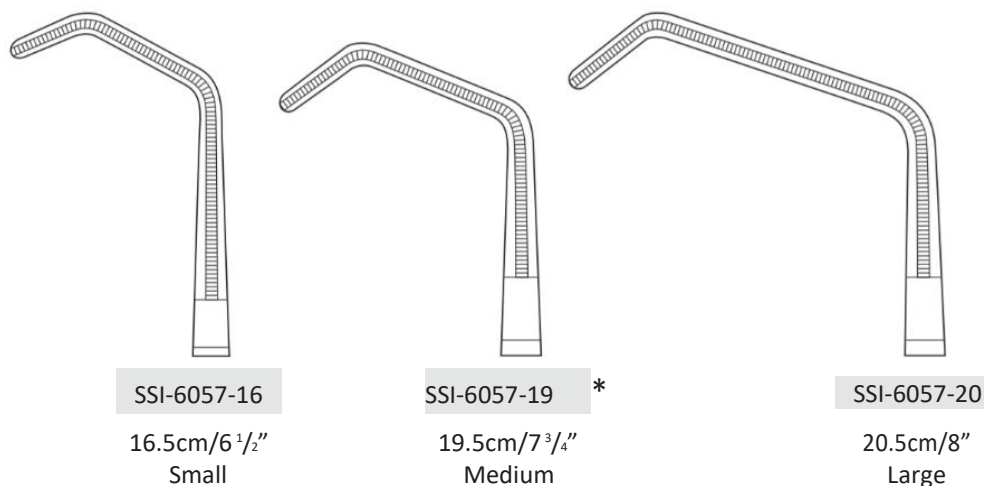

Email: [sheffieldsurgicalinstruments@gmail.com](mailto:sheffieldsurgicalinstruments@gmail.com)  
 Web: [www.sheffieldsurgicalinst.com](http://www.sheffieldsurgicalinst.com)

# VASCULAR CLAMPS

## DeBakey Tangential Occlusion Clamp

- Curved Shanks

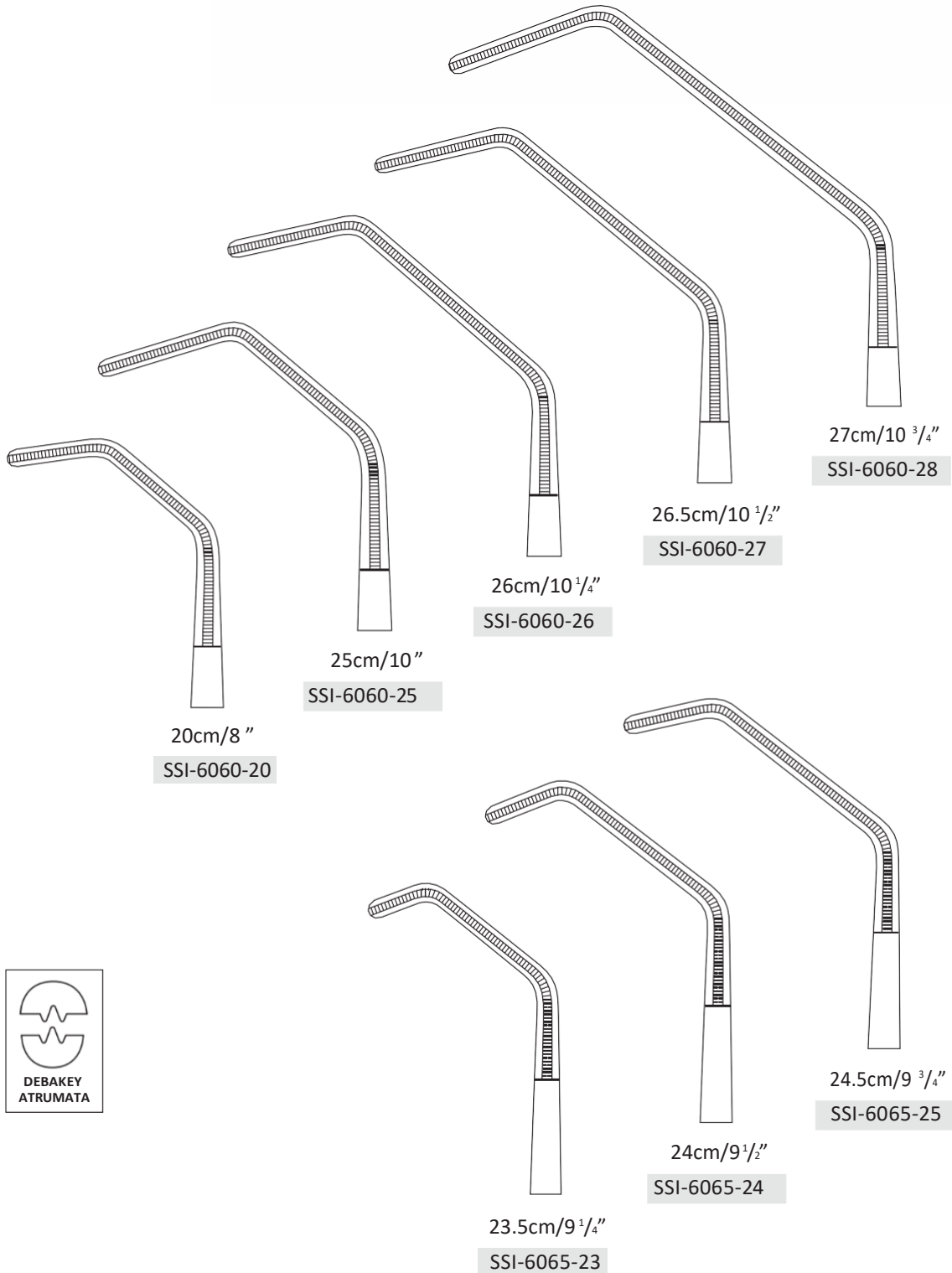
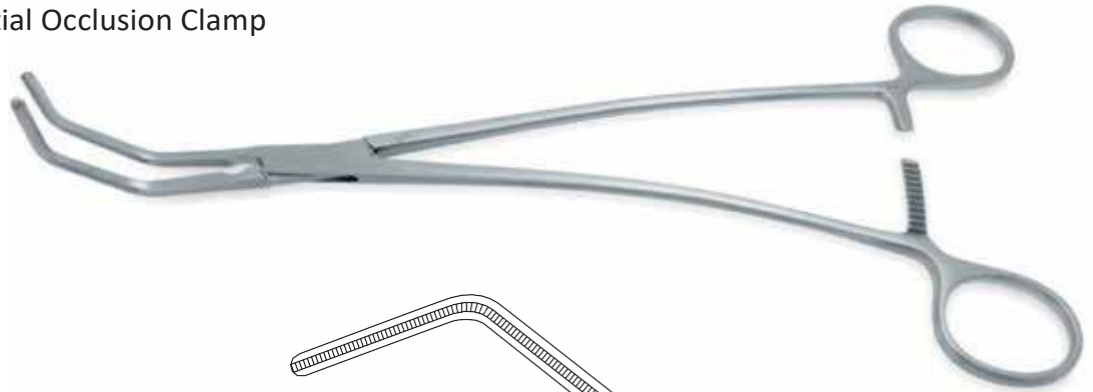

# VASCULAR CLAMPS

## DeBakey Anastomosis Clamp

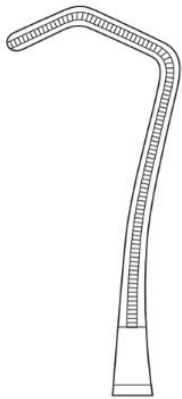

17cm/6<sup>3</sup>/<sub>4</sub>"

SSI-6068-17



## DeBakey-Derra Anastomosis Clamp

- 17cm/6<sup>3</sup>/<sub>4</sub>" length

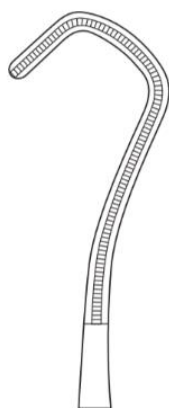

SSI-6070-17

Small

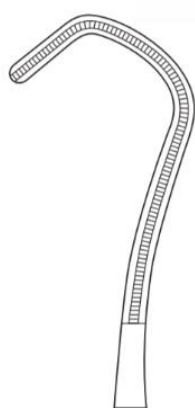

SSI-6071-17

Medium

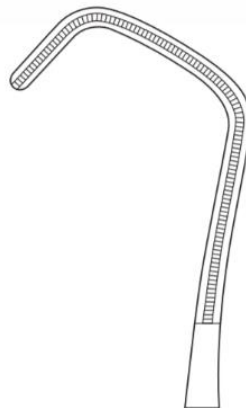

SSI-6072-17

Large



# VASCULAR CLAMPS

## DeBakey-Reynolds Anastomosis Clamp

- Angled Shanks

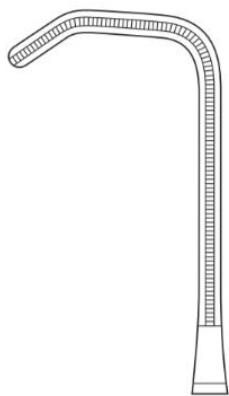

SSI-6090-16

16.5cm/6 1/2"

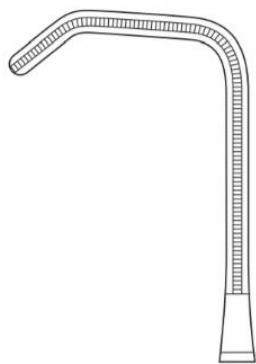

SSI-6091-16

16.5cm/6 1/2"

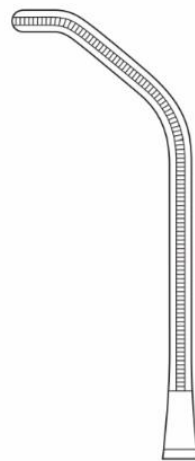

SSI-6092-18

18cm/7"

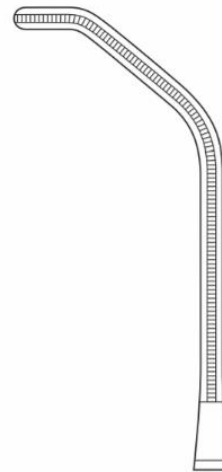

SSI-6093-18

18cm/7"



## DeBakey Curved Anastomosis Forceps

- 17cm/6 3/4" length
- Curved Shanks

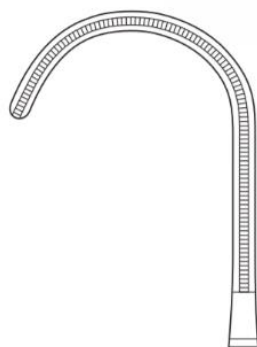

SSI-6076-17

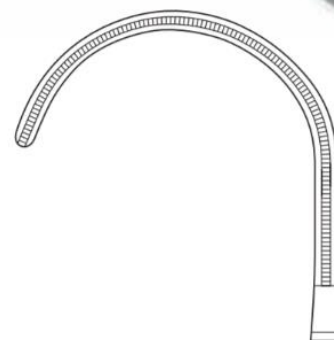

SSI-6077-17



Email: [sheffieldsurgicalinstruments@gmail.com](mailto:sheffieldsurgicalinstruments@gmail.com)  
Web: [www.sheffieldsurgicalinst.com](http://www.sheffieldsurgicalinst.com)

# VASCULAR CLAMPS

## DeBakey-Semb Ligature Carrier

- 25cm/10" length



SSI-6104-25

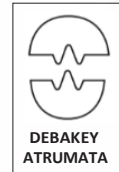

## DeBakey Ligature Forceps

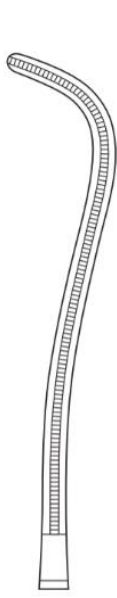

SSI-6107-19

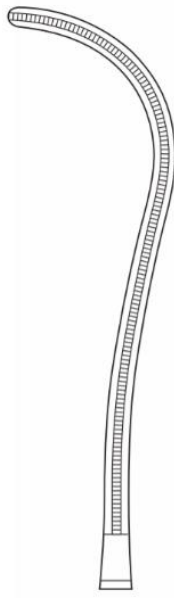

SSI-6108-19



## Semb Ligature Forceps

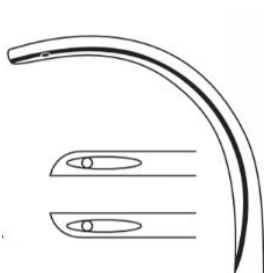

SSI-6110-23



SSI-6111-24



Email: [sheffieldsurgicalinstruments@gmail.com](mailto:sheffieldsurgicalinstruments@gmail.com)  
Web: [www.sheffieldsurgicalinst.com](http://www.sheffieldsurgicalinst.com)

# VASCULAR CLAMPS

## Cooley-Derra Anastomosis Clamp

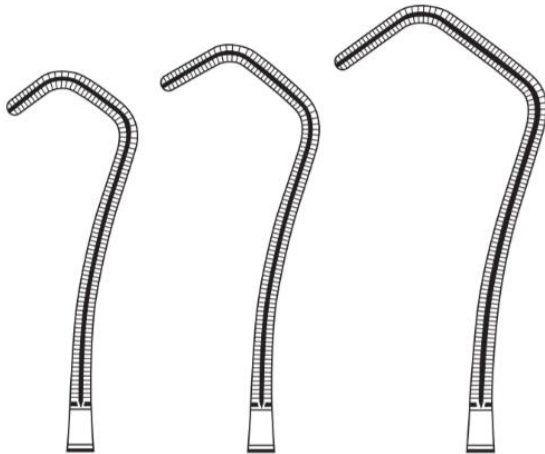

SSI-6115-16

small  
16.5cm/6 1/2"

SSI-6116-17

medium  
17cm/6 3/4"

SSI-6117-17

large  
17.5cm/7"



## Cooley-Beck Vascular Clamp

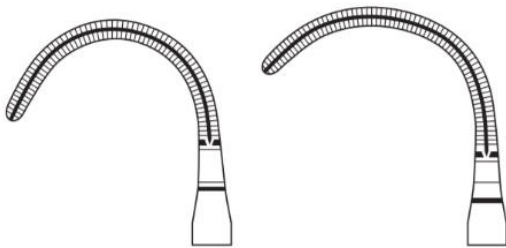

SSI-6120-15

15cm/6"

SSI-6121-15

15cm/6"



## Cooley Coarctation Clamp

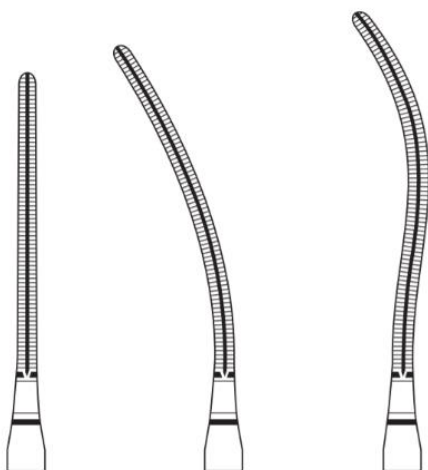

SSI-6140-17

17cm/6 3/4"

SSI-6141-17

17cm/6 3/4"

SSI-6142-18

18cm/7"

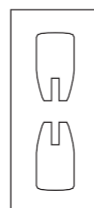

Email: [sheffieldsurgicalinstruments@gmail.com](mailto:sheffieldsurgicalinstruments@gmail.com)  
Web: [www.sheffieldsurgicalinst.com](http://www.sheffieldsurgicalinst.com)



# VASCULAR CLAMPS

## Javid Carotid Clamp

- Small size
- 15cm/6" length

SSI-6200-15



For holding the shunt tube during Carotid Surgery

## Javid Carotid Clamp

- Large size
- 18cm/7" length

SSI-6200-18



## Dardik Multi- Purpose Clamp

Jaw Angle    15cm/6" length    17cm/6 3/4" length

0°	SSI-6125-00	SSI-6130-00
15°	SSI-6125-15	SSI-6130-15
30°	SSI-6125-30	SSI-6130-30
45°	SSI-6125-45	SSI-6130-45
90°	SSI-6125-90	SSI-6130-90

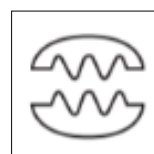
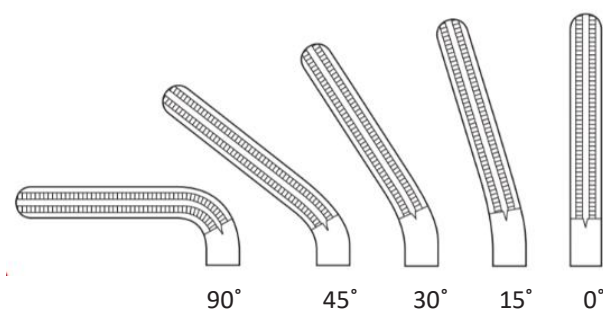

# SUCTION TUBES & CANNULA

## Frazier Suction Tube

- Angled 30°

diameter Ø	Overall Length	
	17cm/6 1/2"	23cm/9"
2.0mm 6FG	SSI-9041-17	SSI-9041-23
2.3mm 7FG	SSI-9042-17	SSI-9042-23
2.7mm 8FG	SSI-9043-17	SSI-9043-23
3.0mm 9FG	SSI-9044-17	SSI-9044-23
3.3mm 10FG	SSI-9045-17	SSI-9045-23
3.7mm 11FG	SSI-9046-17	SSI-9046-23
4.0mm 12FG	SSI-9047-17	SSI-9047-23



## American Pattern Suction Tube

- 16.5cm/6 1/2" length

SSI-7402-16



## Brompton Hospital Suction Tube

- 30cm/11 3/4" length



SSI-7406-30 Adult size for 9.5mm<sup>3</sup>/<sub>8</sub>" tubing

SSI-7407-30 Child size for 6mm<sup>1</sup>/<sub>4</sub>" tubing

## Brompton Hospital Suction Tube

- Paediatric 4.8mm Ø Tip size
- 23cm/9" length
- For 6.5mm<sup>1</sup>/<sub>4</sub>" tubing

SSI-7403-23



## Southampton Western Hospital Suction Tube

- 22cm/8 1/2" length
- Paediatric 3.3mm<sup>1</sup>/<sub>8</sub>" Ø
- For 6.5mm<sup>1</sup>/<sub>4</sub>" tubing

SSI-7401-22



# SUCTION TUBES & CANNULA

## Tibbs Arterial Cannula

- Long Pattern
- Luer lock

Set of 4 **SSI-7200-10**

Large Cone **SSI-7200-20**

Small Cone **SSI-7200-30**

Large Olive **SSI-7200-40**

Small Olive **SSI-7200-50**



## Heparin Flushing Needle

- Luer lock

2mm Ø Tip **SSI-7201-20**

2.5mm Ø Tip **SSI-7201-25**

3mm Ø Tip **SSI-7201-30**



## Magill Suction Tube

- 21cm/8 1/4" length

3mm Ø Tip **SSI-7401-21**

3.5mm Ø Tip **SSI-7402-21**

4.0mm Ø Tip **SSI-7403-21**



## Yankauer Suction Tube

- 30.5cm/12" length

**SSI-7409-30**



## Pooles Suction Tube

- 24cm/9 1/2" length
- 10mm Ø

**SSI-7405-24** Straight mount \*illustrated

**SSI-7406-24** Curved mount



## Paediatric Pooles Suction Tube

- 15cm/6" length
- 6mm Ø

**SSI-7405-15**



# PERFUSION CANNULA

## Ross Atrial Basket



length	tubing size Ø	code
29mm	1/2"/12.7mm	SSI-7205-15
29mm	3/8"/9.5mm	SSI-7205-20
19mm	3/8"/9.5mm	SSI-7205-25
16mm	1/4"/6.3mm	SSI-7205-30

## Ross Sump Sucker (screw apart)



	diameter	tubing size Ø	code
Adult	7.5mm	3/16"/5.0mm	SSI-7206-75
Child	6.5mm	3/16"/5.0mm	SSI-7206-65
Infant	5.0mm	1/8"/3.5mm	SSI-7206-50

## Ross Ventricular Vent (screw apart)



	diameter	tubing size Ø	code
Adult	7.5mm	3/16"/5.0mm	SSI-7207-75
Child	6.5mm	3/16"/5.0mm	SSI-7207-65
Infant	5.0mm	1/8"/3.5mm	SSI-7207-50

## Baylor Sump Sucker (screw apart)



outside diameter	45° angled	90° angled
4.0mm	SSI-7208-40	SSI-7209-40
5.0mm	SSI-7208-50	SSI-7209-50
6.0mm	SSI-7208-60	SSI-7209-60

## Bentall Femoral Cannula

- Rolled edge to bevel



bore Ø	code	bore Ø	code
1.5mm	SSI-7210-15	4.5mm	SSI-7210-45
2.0mm	SSI-7210-20	5.0mm	SSI-7210-50
2.5mm	SSI-7210-25	5.5mm	SSI-7210-55
3.0mm	SSI-7210-30	6.0mm	SSI-7210-60
3.5mm	SSI-7210-35	6.5mm	SSI-7210-65
4.0mm	SSI-7210-40	7.0mm	SSI-7210-70

## Iliac Cannula

- Angled



bore Ø	code	bore Ø	code
2.5mm	SSI-7211-25	4.5mm	SSI-7211-45
3.0mm	SSI-7211-30	5.0mm	SSI-7211-50
3.5mm	SSI-7211-35	5.5mm	SSI-7211-55
4.0mm	SSI-7211-40	6.0mm	SSI-7211-60

## JS Venous Cannula

- Cage tip
- 80° angled
- Long tubing end



bore Ø	code	bore Ø	code
3mm	SSI-7212-30	6mm	SSI-7212-60
4mm	SSI-7212-40	7mm	SSI-7212-70
5mm	SSI-7212-50	8mm	SSI-7212-80

# VESSEL DILATORS & PROBES

## Ross Coronary Artery Probe

- Same thickness along length of shaft

diameter $\emptyset$	10cm length	15cm length
0.5mm	SSI-7301-05	SSI-7302-05
1.0mm	SSI-7301-10	SSI-7302-10
1.5mm	SSI-7301-15	SSI-7302-15
2.0mm	SSI-7301-20	SSI-7302-20
2.5mm	SSI-7301-25	SSI-7302-25
3.0mm	SSI-7301-30	SSI-7302-30



## DeBakey Vessel Dilator

- 190mm length
- Malleable shaft

diameter $\emptyset$	190mm length	diameter $\emptyset$	190mm length
0.5mm	SSI-7303-05	3.5mm	SSI-7303-35
1.0mm	SSI-7303-10	4.0mm	SSI-7303-40
1.5mm	SSI-7303-15	4.5mm	SSI-7303-45
2.0mm	SSI-7303-20	5.0mm	SSI-7303-50
2.5mm	SSI-7303-25	7.0mm	SSI-7303-70
3.0mm	SSI-7303-30	9.0mm	SSI-7303-90



## Garrett Vessel Dilator

- Malleable shaft

diameter $\emptyset$	14cm length	diameter $\emptyset$	21cm length
1.0mm	SSI-7304-10	1.0mm	SSI-7305-10
1.5mm	SSI-7304-15	1.5mm	SSI-7305-15
2.0mm	SSI-7304-20	2.0mm	SSI-7305-20
2.5mm	SSI-7304-25	2.5mm	SSI-7305-25
3.0mm	SSI-7304-30	3.0mm	SSI-7305-30
3.5mm	SSI-7304-35	3.5mm	SSI-7305-35
4.0mm	SSI-7304-40	4.0mm	SSI-7305-40
4.5mm	SSI-7304-45	4.5mm	SSI-7305-45
5.0mm	SSI-7304-50	5.0mm	SSI-7305-50



# STERILISATION CONTAINERS



## SINGLE TRAY CONTAINERS

Internal Dimensions			Code
A	B	C	
200 x	140 x	50mm	SSI-4026/1
280 x	195 x	50mm	SSI-4026/4
265 x	255 x	50mm	SSI-4026/5
380 x	260 x	50mm	SSI-4026/7

E 4026/5

Standard Container illustrated  
One of our popular cases for Micro  
Instruments

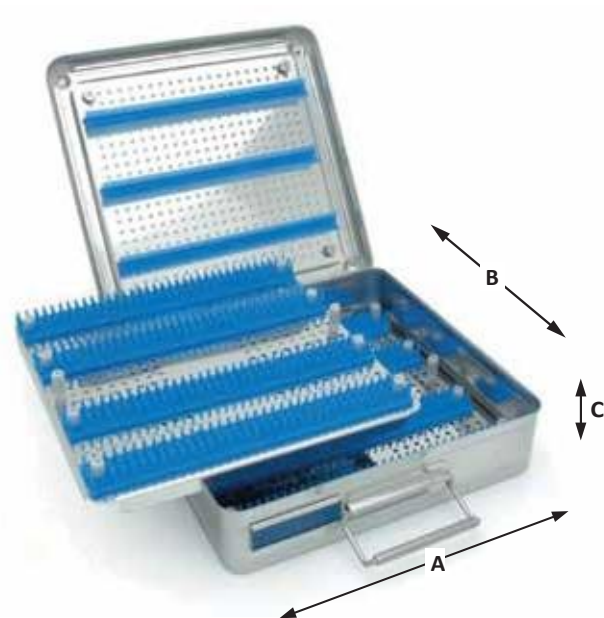

## DOUBLE TRAY CONTAINERS

Internal Dimensions			Code
A	B	C	
280 x	195 x	65mm	SSI-4026/4
265 x	255 x	65mm	SSI-E-4026/5
380 x	260 x	65mm	SSI-E-4026/7 D

E 4026/5D

Double Tray Container illustrated  
Two take-out perforated plates

# MISCELLANEOUS

## Rummel Cardiac Stilette

- Suture Hook
- 32.5cm length



SSI-7008-32

## Diamond Knife

- Titanium Handle with retractable blade
- 1mm x 6mm blade
- For neuro or cardiac surgery



45° Angled Blade

SSI-7001-00

## Stainless Steel Measuring Ruler

Code	Length
SSI-5005-15	15cm/6"
SSI-5005-30	30cm/12"





SHEFFIELD SURGICAL BUILDING  
Wazirabad Road, Ugoki, Sialkot-51310 Pakistan.

WhatsApp # +92-333-1400682  
Email: [sheffieldsurgicalinstruments@gmail.com](mailto:sheffieldsurgicalinstruments@gmail.com)  
Email: [info@sheffieldsurgicalinst.com](mailto:info@sheffieldsurgicalinst.com)  
Web: [www.sheffieldsurgicalinst.com](http://www.sheffieldsurgicalinst.com)

